

# EPSILON Sky R7

6 ÷ 45 kW

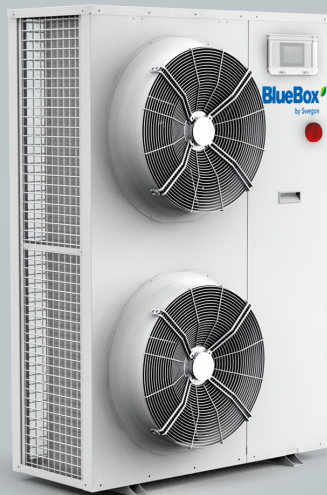

## General

Chillers and reversible heat pumps with hermetic compressors (twin rotary or scroll) and plate heat exchanger. Extended range, versatile applications.

## Configurations

Hi: chiller with inverter compressor

Hi HP: Reversible heat pump version, with inverter compressor

HP: reversible heat pump version

Hi LE: motocondensing execution with inverter driven compressor

Hi HP LE: reversible motocondensing execution with inverter driven compressor

## Strengths

- ▶ High efficiency and compact dimensions
- ▶ High output water temperature: up to 60°C
- ▶ R32 refrigerant with Low GWP
- ▶ Reduced refrigerant charge
- ▶ Application Flexibility
- ▶ BlueThink advanced control. Multilogic function and Blueeye® supervision system. (options)
- ▶ 4.3" touch screen interface
- ▶ Flowzer: inverter driven pumps (options)

**BlueBox**   
by Swegon



---

## **EPSILON Sky R7**

<b>Description of accessories</b>	<b>8</b>
Refrigerant circuit accessories	8
Fan accessories	9
Hydraulic circuit accessories	10
Flowzer options	11
Electrical accessories	21
Network accessories	25
Other accessories	28
<b>Technical specifications</b>	<b>29</b>
<b>Ecodesign</b>	<b>34</b>
<b>Electrical specifications</b>	<b>39</b>
<b>Hydraulic modules</b>	<b>42</b>
<b>Pump data</b>	<b>43</b>
<b>User-side exchanger flow rate fields</b>	<b>44</b>
<b>Operating limits</b>	<b>45</b>
EPSILON Sky Hi R7	45
EPSILON Sky Hi HP R7	46
EPSILON Sky HP R7	48
EPSILON Sky Hi LE R7-EPSILON Sky Hi HP LE R7	49
<b>Noise levels</b>	<b>51</b>
<b>Installation advice</b>	<b>52</b>
Water characteristics	52
Glycol mixtures	52
Minimum water content in the system	53
Installation site	54
Installations that require the use of treated coils	55



---

## EPSILON Sky R7

EPSILON Sky R7 is a range of high-efficiency air-cooled reversible chillers and air-source heat pumps with hermetic (twin rotary or scroll) compressors, suitable for both comfort and process applications. As versões de chiller podem produzir água gelada de -10°C a 20 °C, com temperaturas externas de -20°C a + 45 °C. Heat pump versions are designed for the production of hot water up to 60°C, with outside temperature down to -20°C. Versions featuring a variable speed inverter compressor are designed to maximise seasonal efficiency. The entire range is characterised by high compactness and a reduced refrigerant charge. EPSILON Sky R7 uses low GWP refrigerants that have a low environmental impact.

### REFRIGERANT

The unit is charged with refrigerant R32.

Acronym "R7" indicates the need to use refrigerant R32 and it shows that the refrigerant has a GWP level below 700.

Refrigerant R32 (GWP=677\*)

The refrigerant consists in pure gas.

R32 is classified as a Group 1 fluid under PED.

It is also classified as A2L under the ASHRAE Standard 34, i.e.

- non-toxic;
- mildly flammable.

(\*) GWP (AR5), pursuant to IPCC V, evaluated over a span of 100 years.

### STRUCTURE

The structure of the unit is made of galvanized sheet-iron coated with polyester powder in RAL 5017/7035 at 180°C, which makes it highly resistant to weather conditions.

The structure is a load-bearing frame, with removable panning lined with sound absorbing expanded polyurethane matting.

HP configurations are equipped with condensate drip tray with corresponding drain.

### COMPRESSORS

#### EPSILON Sky Models 6 -12

Hermetic 'twin rotary' compressor, complete with rubber vibration damping supports.

#### EPSILON Sky Models 18 - 24 - 30 - 36 - 45

Hermetic scroll compressor, complete with rubber vibration damping supports.

On-off compressors are fitted as standard with crankcase heater.

#### EPSILON Sky Hi and Hi HP versions - All models

Modulating compressor with brushless permanent magnet motor, driven by inverter.

This also has the following functions:

- management of acceleration and deceleration ramps
- management of the operating envelope of the modulating compressor
- management of the alarms and safety devices of the modulating compressor

The use of a modulating compressor allows the total inrush current to be reduced because it is always started with an acceleration ramp.

---

## SOURCE-SIDE HEAT EXCHANGER

### (for chiller version)

It consists of a coil with copper tubes and aluminium fins having a large exchange surface with fin pitch sized to maximize heat exchange and to reduce the noise impact.

Options are available for installation in environments with a particularly aggressive atmosphere or in coastal or highly industrialized areas. See section: "Description of accessories".

### (for heat pump version)

It consists of a coil with copper tubes and aluminium fins having a large exchange surface with fin pitch sized to maximize heat exchange and to reduce the noise impact. The coils have an increased fin pitch to reduce frost formation and to facilitate the outflow of condensed water during defrosting. The finned coil is installed as standard including suitable hydrophilic treatments for easier condensed water drainage from the coil. This treatment causes the water vapour to form a film of condensate on the surfaces of the fins, which, thanks to the low surface tension, drains rapidly into the drip tray (if present) positioned beneath the coils.

Options are available for installation in environments with a particularly aggressive atmosphere or in coastal or highly industrialized areas. See section: "Description of accessories".

## FANS

The fans are axial fans, directly coupled to a 6-pole electric motor, with integrated thermal overload protection (Klixon®) and IP 54 protection rating.

The fan includes the shroud, designed to optimize its efficiency and reduce noise emission to a minimum, and the safety guard.

The control manages the speed of the fans through a phase cutting speed adjuster, in order to optimize the operating conditions and efficiency of the unit.

The fan speed regulator is supplied standardly.

This control also has the effect of reducing the noise level of the unit: in fact, the typical conditions under which the control will be modulating the speed of the fans are those of the night, spring and autumn.

For units equipped with EC fans (option), the same function is carried out using the electronically commutated motor of the fans.

## USER-SIDE HEAT EXCHANGER

The exchanger is a braze-welded stainless steel plate heat exchanger, insulated with a shroud of closed-cell insulating material.

The heat exchanger is provided with a temperature probe for freeze protection, a probe for measuring the temperature of the input and output water and a paddle flow switch that is standardly supplied with it.

The exchanger is protected as standard by an electric anti-freeze heater managed by the controller of the unit.

Not present in the LE version.

## REFRIGERANT CIRCUIT

Each refrigerant circuit of the basic unit comprises:

- valve on the liquid line (only LE version)
- 4-way reversing valve (applies to HP versions only)
- isolating valve on gas line (only LE version)
- liquid receiver (for heat pump version and condensing unit version)
- charging valves
- liquid sight glass
- Weld-on filter drier
- Bi-flow electronic expansion valve
- high pressure switch
- high and low pressure transducers
- safety valve (for Hi configurations only from size 18)

The pipes of the circuit and the exchanger are insulated with extruded closed-cell expanded elastomer.

## ELECTRICAL CONTROL PANEL

The electrical panel is made following the EN60204-1 standard.

The electrical control panel is made in a painted galvanized sheet-iron box with IP54 protection rating. The electrical control panel of the basic unit comprises:

- main disconnect switch
- automatic circuit breakers for compressors and fans
- fuses to protect the auxiliary circuits
- phase-cutting fan speed adjuster
- thermal magnetic circuit breakers for pumps (if present)
- potential-free general alarm contacts
- digital input for general ON/OFF
- digital input for smart grid (only for HP units)
- summer/winter selection by digital input (only for HP units)
- external air temperature probe
- microprocessor controller with display accessible from the outside
- 0-10V for external management of compressor modulation (only for /LE and /LE/HP versions)

All the electrical cables inside the panel are numbered and the terminal board dedicated to the customer's connections is coloured orange so that it can be quickly identified in the panel.

The main power switch is supplied with a door lock handle that prevents opening of the electrical control panel door if the power supply is enabled.

The unit's power supply is 230V/1~/50Hz for the following models:

- Size 6

The unit's power supply is 230V/1~/50Hz or 400V/3~+N/50Hz for the following models:

- Size 12

The standard power supply of the unit is 400V/3~+N/50Hz for the following models:

- from size 18 up to size 45

---

## CONTROL BLUETHINK

The unit is supplied as standard with an advanced controller.

The control allows the following functions:

- water temperature adjustment, with control of the water entering the user-side heat exchanger
- freeze protection
- compressor timings
- automatic rotation of compressor starting sequence
- recording of the log of all machine inputs, outputs and states
- automatic rotation of compressor starting sequence
- recording of the alarm log
- RS485 serial port with Modbus protocol
- Ethernet serial port with Modbus protocol
- digital input for general ON/OFF
- digital input for Summer/Winter selection (only for HP units)

For further details on available functions and on displayed information, refer to the specific documentation of the controller.

By default, the serial connections present as standard are enabled only for reading from BMS. Enabling of writing from BMS is to be requested when ordering.

### Main functions of the webserver (option)

The Bluethink controller integrates a webserver with a preloaded web page that is accessed via password.

The web page allows the following functions to be carried out (some of these are available only for users with advanced level rights):

- display of the main functions of the unit such as unit serial n°, size, refrigerant
- display of the general status of the machine: water inlet and outlet temperatures, external air temperature, mode (chiller or heat pump), evaporating and condensing pressures, suction and discharge temperatures
- display of the status of compressors, pumps, expansion valves
- display in real time of the graphs of the main quantities
- display of the graphs of logged quantities
- display of alarm log
- management of users on several levels
- remote ON/OFF
- remote set point change
- remote time band change
- remote summer winter mode selection (only for HP units)

## Human-Machine Interface

The graphic terminal is a 4.3" touch screen panel. The touch screen panel is also designed for easier man-machine interaction as it makes screen browsing much more user-friendly.-



The display allows the following information to be shown:

- water inlet and outlet temperature
- set temperature and differential set points
- description of alarms
- hour meter of operation and number of start-ups of the unit, the compressors and the pumps (if present)
- high and low pressure values, and relevant condensing and evaporating temperatures
- external air temperature
- superheating at compressor suction.

### Management of defrost cycles

#### (only for HP units)

For defrost management, the control of the unit uses a sliding intervention threshold, depending on the pressures inside the unit and the external air temperature. By putting together all this information, the control can identify the presence of ice on the coil and activates the defrosting sequence only when necessary, so as to maximize the energy efficiency of the unit.

Sliding management of the defrost threshold ensures that, as the absolute humidity of outdoor air decreases, the frequency of the defrost cycles gradually decreases because they are carried out only when the ice formed on the coil actually penalizes performance.

The defrost cycle is fully automatic: during the initial stage, a defrost is carried out by cycle reversal with the fans stopped. As soon as the frost on the coil has molten to a suitable level, the unit resumes operation in heat pump mode.

---

## VERSIONS

### Hi LE: motocondensing execution

LE version units are without the utility exchanger.

The units are supplied with:

- electronic expansion valve
- refrigerant charge (refer to manual for further guidance)
- flare nut or flanged refrigerant connections

### Hi HP LE: reversible motocondensing execution

LE HP version units are without the utility exchanger.

The units are supplied with:

- electronic expansion valve
- refrigerant charge (refer to manual for further guidance)
- flare nut or flanged refrigerant connections
- 4-way reversing valve

## HYDRAULIC MODULES

All units can be fitted with hydraulic module in various configurations:

- /1P: hydraulic module with one pump
- /1PS: hydraulic module with one pump and buffer tank

The following are also available:

- modules /1PM, /1PMS that have pumps with increased available discharge head

Hydraulic modules with one pump have:

- one pump
- an expansion vessel

Hydraulic modules with tank also have:

- a gate valve at the inlet of the pump or the suction manifold
- a tank with drain valve and air valve

Refer to the table of configurations that are not possible to check for availability of specific set-ups.

All the hydraulic circuit components are fully insulated, except for:

- drain valves
- venting valves
- tank plugs
- safety valves
- expansion vessel
- probe pockets

## CONTROLS AND SAFETY DEVICES

All the units are fitted with the following control and safety components:

- user-side water temperature probe
- antifreeze probe on the user side heat exchanger
- high pressure switch with manual reset
- compressor overtemperature protection
- fan overtemperature protection
- Mechanical vane type flow switch included in the standard supply

## TESTING

All the units are factory-tested and supplied complete with oil and refrigerant.

## PACKAGING

The unit is made and shipped on a wooden pallet that allows the unit to be handled using a forklift truck.

The unit is wrapped in a protective transparent polyethylene stretch film.



---

## **CERTIFICATIONS AND REFERENCE STANDARDS**

### **Responsibilities and obligations exclusive to the installer:**

The manufacturer has implemented and keeps the Management Systems listed below and it is certified against them:

- Quality Management System according to standard UNI EN ISO 9000;
- Environmental Management System according to standard UNI EN ISO 14000;
- Health and Safety Management System according to standard BS OHSAS 18000 (as converted into UNI EN ISO 45000).

These management systems ensure that the company puts in place any and all actions and initiatives to define and monitor the standards defined by its Management, which are stated in its Quality, Environmental and Safety policies.

To meet the safety requirements, the unit was designed and manufactured in compliance with the directives and product regulations below:

- PED Directive: safety criteria to be followed when designing pressure equipment;
- Machinery Directive: safety criteria to be followed when designing machinery;
- Low Voltage Directive: safety criteria to be followed when designing electrical machine parts;
- Electromagnetic Compatibility Directive: electromagnetic compatibility criteria to be followed when designing electrical machine parts;
- WEEE Directive: criteria for product management at the end of its life cycle as waste with a view to environmental protection.

The units are manufactured, tested and checked with reference to the European standards specified in the Declaration of CE Conformity, in accordance with the requirements and procedures of our Quality System.

The installation, use and storage of units featuring mildly flammable refrigerants (A2L pursuant to standard ASHRAE 34), such as R32 and R454B, must meet the European standards and regulations and the local laws, where applicable.

For further details, please refer to the "Instruction manual for operation and maintenance".

- to carry out a specific risk assessment according to the European regulations/standards above and/or the local laws in order to define the necessary measures for conformity;
- to comply with the requirements and to take the measures resulting from the outcomes of the risk assessment, pursuant to the relevant regulations and standards.

---

## DESCRIPTION OF ACCESSORIES

Some accessories may be incompatible with each other even if not expressly indicated.

### Refrigerant circuit accessories

---

**BC      Capacitive backup battery for electronic expansion valve**

When the compressors stop, the controller always closes the electronic expansion valve to prevent dangerous refrigerant migration. The presence of the backup battery ensures that the electronic valve is kept in closed position even when there is no power supply

This option uses a condenser as energy storage, and not an ordinary coil. In this way, it is not affected by the memory effect of normal coils and the need for maintenance is avoided.

Applies to units with advanced controller.

**BK      Brine Kit**

This accessory is compulsory if a water temperature set point lower than or equal to +3°C is used (if the unit is provided with double set point or variable set point, the lower set point is considered).

The accessory consists of increased insulation and suitable sizing and calibration of some components.

The inlet and outlet temperatures of the user-side exchanger must be given on ordering to allow correct setting of the alarm parameters and verification of the sizing of the expansion valve.

The cooling set point can then be changed by the customer in an interval that, compared to the set point given on ordering, ranges from -1K up to the allowed limit temperature.

The unit will be optimized to work at the set point temperature given on ordering. For different set points, the cooling capacity provided and the level of efficiency of the machine could decrease and move away from these conditions.

**RPR      Refrigerant leak detector**

With this accessory, a refrigerant leak detector is placed inside each compressor compartment. Detection of a refrigerant leak is managed by the controller through a specific alarm and display of a specific icon on the display of the controller. This alarm stops the unit.

---

## Fan accessories

---

### **VEC**    **EC fans**

With this accessory, EC fans, with electronically commutated brushless motor, are used for the ventilating section. These guarantee very high efficiency levels for all working conditions and allow a 15% saving on the power absorbed by each fan working at full capacity.

Also, through a 0-10V analogue signal sent to each fan, the microprocessor carries out condensation/evaporation control by continuous adjustment of the air flow rate as the external air temperature changes, with a further reduction in electrical absorption and noise emission.

For further details, see the dedicated chapter: "Aeraulic head losses and options available for the fan section".

---

## Hydraulic circuit accessories

---

### **GRPC Filling unit with pressure gauge**

This accessory allows automatic filling of the hydraulic system and control of correct operating pressure, which can always be checked on the pressure gauge, and continuously maintains this pressure by replenishing with water if necessary.

### **RA Antifreeze heater**

These electric heaters are fitted on the pumps and in the tank (depending on the configuration of the machine) to prevent damage to the hydraulic components due to ice formation during periods when the machine is inactive.

Based on normal operating conditions and the percentage of glycol in the system, an appropriate "antifreeze alarm" temperature is set in the control. When a temperature that is 1K higher than the antifreeze alarm threshold is detected at the outlet from the exchanger, the pump (if present) and the antifreeze heaters are switched on. If the temperature of the outgoing water reaches the antifreeze alarm threshold, the compressors are stopped, keeping the heaters and the pumps active, and the general alarm contact of the machine is activated.

The antifreeze heater is only featured as a standard component on the user-side heat exchanger.

### **FW Water filter**

To protect the elements of the hydraulic circuit (in particular, the exchangers), there are Y filters that can stop and settle the particles that are normally present in the water flow and would otherwise settle in the more delicate parts of the hydraulic circuit and damage its heat exchange capacity.

Installation of the water filter is mandatory even when it is not supplied as an accessory.

Accessory supplied loose.

### **V3E External 3-way valve for domestic hot water management**

This is a three-way on-off valve, complete with servo control. The unit controller can manage two separate hydraulic circuits through this valve: one for comfort and one for domestic hot water production.

The valve and the servo control are for indoor installation and they require the ambient temperature not to drop below -10°C.

Accessory supplied loose. Installation by the customer.

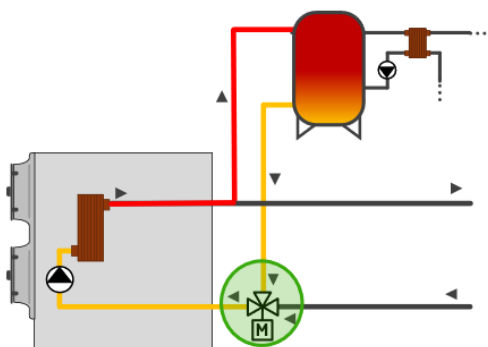

**\*\*non tradotto\*\*    \*\*non tradotto\*\***  
\*\*non tradotto\*\*

## Flowzer options

Our range of Flowzer options offers flexible and scalable solutions to set the speed of pumps in the system with a view to optimising and reducing energy consumption. Different types of control modes are offered based on the system and application type:

- FLOWZER VP - Inverter for manual pump adjustment
- FLOWZER VD - control of available pump discharge head for variable flow systems without monitoring the flow rate limits;
- FLOWZER VDE - flow rate control to keep the flow rate constant as the external working conditions of the system change;
- FLOWZER VDT - flow rate control with constant TD (difference between input and output temperature in the heat exchanger on the user side) in variable flow pumps, without monitoring the flow rate limits;
- flowzer vps with TD-based control - automatic management of variable flow rate, including control with constant TD (difference between input and output temperature in the heat exchanger on the user side) in systems featuring both the primary and secondary circuits.

The tables below summarise the main system diagrams and show the application type and advantages/disadvantages offered by each solution. Each individual option is illustrated and explained individually in the next pages.

The hydraulic diagrams in this document are for exemplification purposes only and their main function is to help the reader understand the type of machines and devices the controller can manage. For a more technical evaluation of the system, please refer to the dedicated manual.

<b>Constant flow system</b>			
	<b>Application</b>	<b>Advantages</b>	<b>Disadvantages</b>
<b>Flowzer VP</b>	Ideal for constant flow systems The option is given to set two different speeds: one for heating and one for cooling mode or one for chiller and one for FC mode. This solution replaces the 2-way regulating valve.	<ul style="list-style-type: none"> <li>- Increased efficiency: increased "REAL" EER of the unit installed, considering the power consumption of the pumps in real installation conditions and in real operating conditions.</li> <li>- Reduced installation times and costs: quick setup of water flow using the display.</li> </ul>	This solution doesn't allow to save energy in the pump under part load conditions, due to the possibility to only set two frequency values in the inverter.
<b>Flowzer VDE</b>	Ideal for constant flow systems to keep the water flow to the heat exchanger constant under all conditions	<ul style="list-style-type: none"> <li>- Plug&amp;Play: provides for easy and flexible implementation as it is not supplied with options to be fitted therefore allows for quick commissioning.</li> </ul>	This solution is less efficient as losses in the heat exchanger are kept constant under all conditions (including in cases when they may be reduced).

**FLOWZER VP**

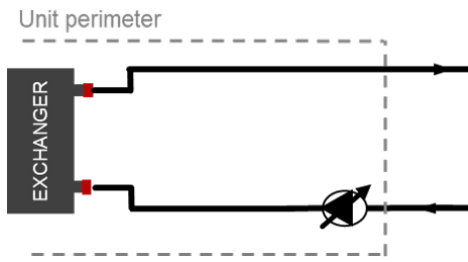

**FLOWZER VDE**

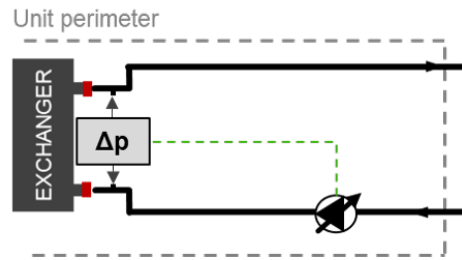

**Variable flow system featuring primary and secondary circuits**

	Application	Advantages	Disadvantages
<b>Flowzer VDT</b>	Ideal for systems featuring similar users or users with similar operating conditions. It is recommended in structured systems in which the client has third-party systems to control the min. and max. flow rate.	- Plug&Play: provides for easy and flexible implementation as it is not supplied with options to be fitted and for quick commissioning.	Risk of over- or underflow for some of the users in the secondary circuit if they have different operating conditions (same temperature difference). A control is required by third-party equipment to ensure compliance with the unit flow limits.
<b>FLOWZER VPS with TD-based control</b>	Ideal for systems featuring similar users or users with similar operating conditions. Ideal for systems featuring a primary and a secondary circuits physically divided from the heat exchanger or a tank with multiple connections.	- Plug&Play: provides for easy and flexible implementation as it is not supplied with options to be fitted and for quick commissioning.	Risk of over- or underflow for some of the users in the secondary circuit if their temperature difference is not the same due to the existing operating conditions.

**FLOWZER VDT**

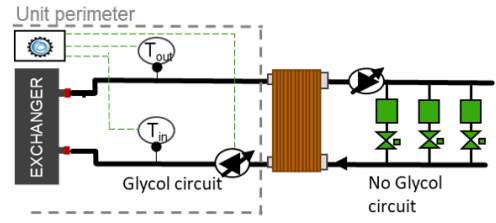
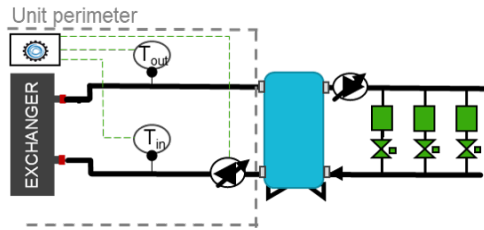

**FLOWZER VPS with DT-based control**

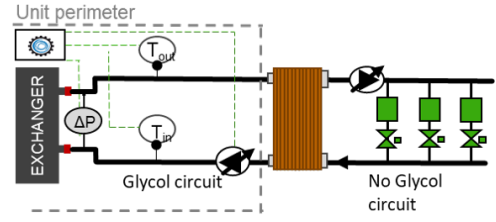
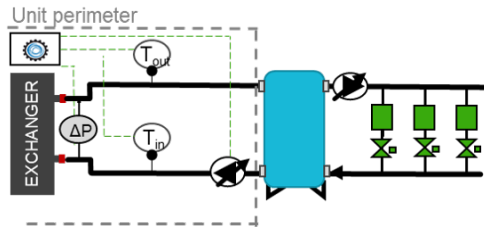

**Variable flow system featuring primary circuit only**

	Application	Advantages	Disadvantages
<b>Flowzer VD</b>	Ideal for systems fitted with changing users according to the season. Ideal for industrial processes, such as injection moulding, in order for each terminal to operate with the correct discharge head. It is recommended in structured systems in which the client has third-party systems to control the min. and max. flow rate.	- Plug&Play: provides for easy and flexible implementation as it is not supplied with options to be fitted therefore allows for quick commissioning.	A control is required by third-party equipment to ensure compliance with the unit flow limits.

**Flowzer VD**

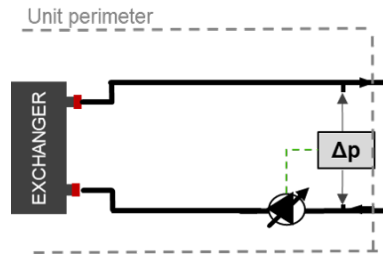



**FVP FLOWZER VP - Inverter for manual pump adjustment**

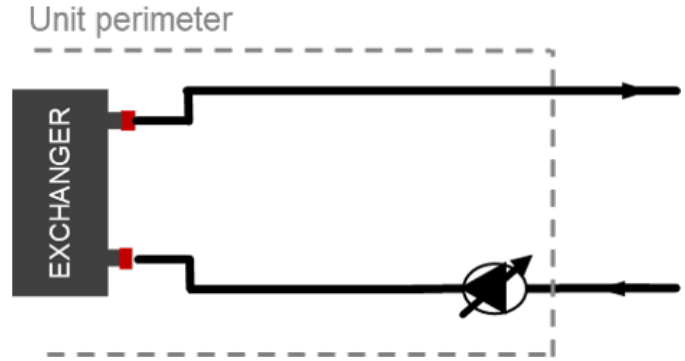

The accessory consists of inserting an inverter in the machine to manually adjust the speed of the pump (or pumps) in order to calibrate the pump flow rate on the head losses of the system. This accessory is to be combined with one of the integrated hydraulic modules that can be selected for the unit. Units equipped with integrated hydraulic module allow a certain level of available discharge head (point A) to be obtained under nominal flow rate conditions  $Q_d$ . But the actual head loss level of the system (e.g. characteristic curve  $R'$ ) normally causes the pump to find a different equilibrium point (point B), with a flow rate  $Q_r$  higher than  $Q_d$ . In this condition, in addition to having a different flow from the nominal one (therefore also a different temperature jump), there is also a greater absorption of electric power from the pump itself.

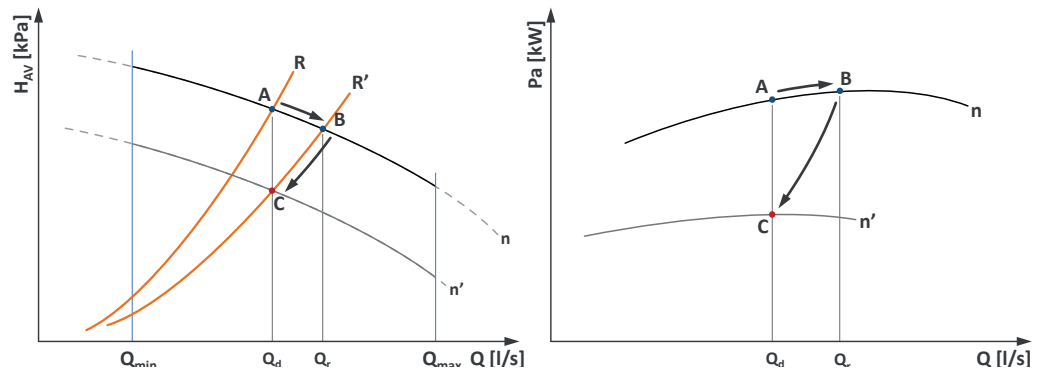

The use of the Flowzer allows the pump speed to be set manually (e.g. at speed  $n'$  instead of  $n$ ) to obtain the design water flow rate and thermal gradient (point C). Once the adjustment procedure has been carried out, the pump will always work at a fixed flow rate.

The adoption of the VP Flowzer allows to considerably reduce the electrical power consumption of the pump with a consequent energy saving. By way of example, a reduction in the flow rate of 10% leads to a reduction in power consumption of around 27%.

For the freecooling units the Flowzer VP is able to manage two different speeds of the pump automatically compensating the pressure drops of the water coil.

**FVD FLOWZER VD - control of available pump discharge head for variable flow systems without monitoring the flow rate limits;**

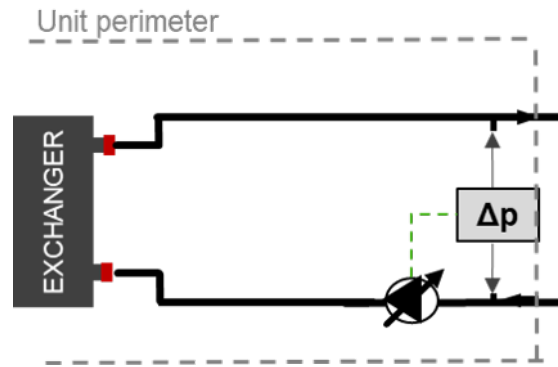

Flowzer VD requires two pressure transducers to be installed in the machine. Through these transducers, the inverter can gauge the actual pressure at the ends of the system and it can automatically adapt the pump speed to obtain a set available discharge head value. Flowzer VD must be combined with Flowzer VP. This accessory therefore allows a constant pressure system to be achieved.

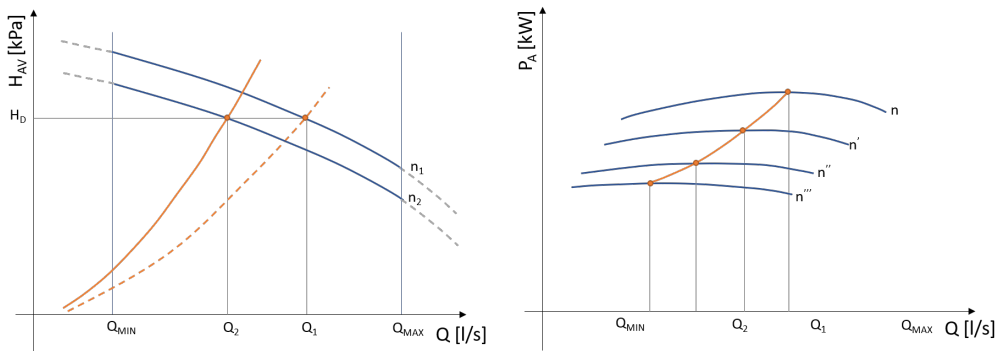

With the Flowzer VD, the customer can set, directly on the display, the available discharge head value ( $H_d$ ) that the unit must maintain. As can be seen from the graph as the user request decreases, the resistant curve of the plant moves to the left, consequently the inverter reduces the speed of the pump in order to maintain the useful head necessary for the unit. With this system a significant reduction in electrical power is achieved. The customer will have to check that, in minimum flow rate conditions (that is, with the maximum number of user points closed), this is always higher than or equal to the minimum flow rate allowed by the unit. This accessory is useful when the total head losses of the circuit are slightly variable or when they change depending on the seasons (for example, some user points are active only during summer operation and not during winter operation). The use of this accessory also allows the pump speed to be adapted to possible fouling of the filter on the hydraulic circuit.

**FVDE FLOWZER VDE - flow rate control to keep the flow rate constant as the external working conditions of the system change;**

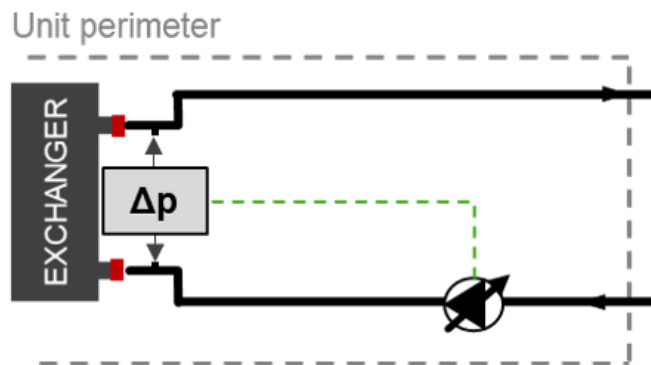

Flowzer VDE requires a differential pressure transducer to be installed in the machine. Through this transducer, the inverter can gauge the actual pressure at the ends of the heat exchanger installed in the machine and it can automatically adapt the pump speed for a constant flow value under all conditions. Flowzer VDE must be combined with Flowzer VP.

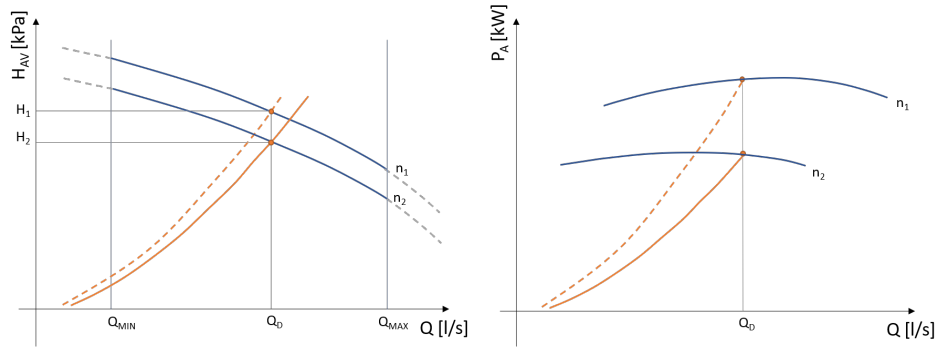

Flowzer VDE is used to automatically adjust the pump speed. As the graph shows, the inverter trips and increases the pump speed if a different condition occurs which would cause an undesired drop in the flow rate (e.g. operation of an external dry cooler). This is a more accurate solution than the VP option alone as it always provides for the water flow ( $Q_D$ ) required by the design conditions.

**FVDT FLOWZER VDT - flow rate control with constant TD (difference between input and output temperature in the heat exchanger on the user side) in variable flow pumps, without monitoring the flow rate limits;**

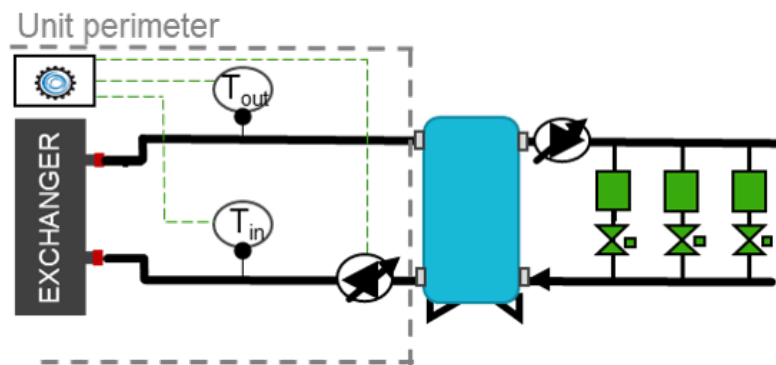

Flowzer VDT uses the temperature sensors installed at the inlet and outlet of the heat exchanger to automatically adjust the pump speed, thus keeping the  $T$  delta difference setpoint constant.

The option is not compatible with the Multilogic version. Please refer to the HYZER solutions for the compatibility between variable flow systems and multi-machine systems.

The unit must include the advanced Bluethink controller and just one heat exchanger on the user side.

With the Flowzer VDT, the customer can set, directly on the display, the available delta  $T$  value that the unit must maintain. The customer will have to check that, in minimum flow rate conditions (that is, with the maximum number of user points closed), this is always higher than or equal to the minimum flow rate allowed by the unit.

This option is specifically designed for systems in which the system users have similar operating conditions (same temperature difference).

**FVPD FLOWZER VPS with TD-based control - automatic management of the variable flow rate, including control with constant temperature difference (TD) in the heat exchanger on the user side in systems featuring both the primary and secondary circuits.**

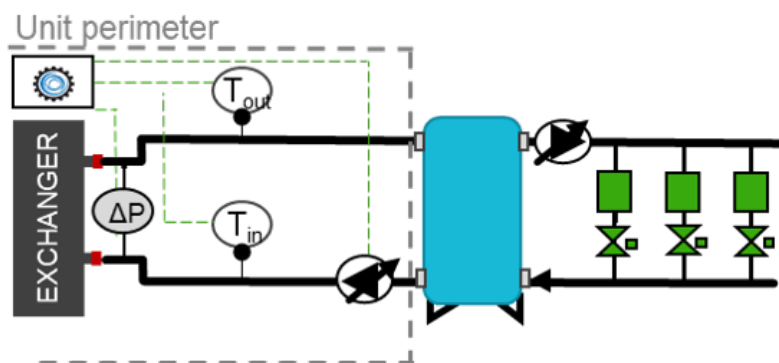

Bluethink solution for variable flow systems - ideal for systems featuring a primary and a secondary circuit physically divided by a heat exchanger or a tank with multiple connections.

flowzer vps with TD-based control includes:

- a differential pressure transducer, installed at the factory at the ends of the user-side heat exchanger of the unit ( $\Delta p_e$ )

The option must be necessarily combined with the Flowzer VP (inverter) and with one of the hydraulic modules that can be selected for the unit. The option is not compatible with the Multilogic version. Please refer to the HYZER solutions for the compatibility between variable flow systems and multi-machine systems.

The unit must include the advanced Bluethink controller and just one heat exchanger on the user side.

The option offers a complete default package to guarantee simple selection, purchasing and commissioning.

flowzer vps with TD-based control offers the following advantages:

- a full package that is easy to install as all the regulating devices are pre-assembled and pre-wired in the unit;
- achieving a complete variable flow system, with maximum energy saving
- the ideal solution to refurbish existing systems where the T different must be kept constant in the system, especially in comfort applications;

The maximum energy saving is achieved thanks to the advanced algorithm, which prevents hunting by the inverter and balances the pump speed and the recirculation flow rate to a minimum.

The dimensions of the inverter of the unit and of the pump module can be favoured by the low design discharge head of the primary circuit.

The operating principle can be summarized as follows:

- flowzer vps with TD-based control performs smart monitoring of the flow rate in the primary circuit, keeping the T difference constant in the heat exchanger;
- the system controller modulates the pump speed according to the condition detected by the temperature sensors (T) in the system, which are installed at the inlet and outlet of the heat exchanger on the user side;
- the difference in the water temperature (T) and flow rate are inversely proportional, which is why if the T difference is reduced at the same performance level, the water flow exceeds the flow required by the system and the pump speed is reduced in order to save energy;

on the other hand, when the load increases, the T difference increases in the system and the pump speed is increased accordingly.

- The check contributes to reducing/increasing the speed of the pump in the primary circuit until the min./max. flow threshold admitted in the heat exchanger of the unit is exceeded.
- this flow rate is indirectly monitored through the losses detected by the differential pressure transducer  $\Delta p_e$

The temperature sensors of the system output a 4-20 mA signal.

Further details can be found in the relevant manual.

## HDx HYZER E VPS with DT-based control function

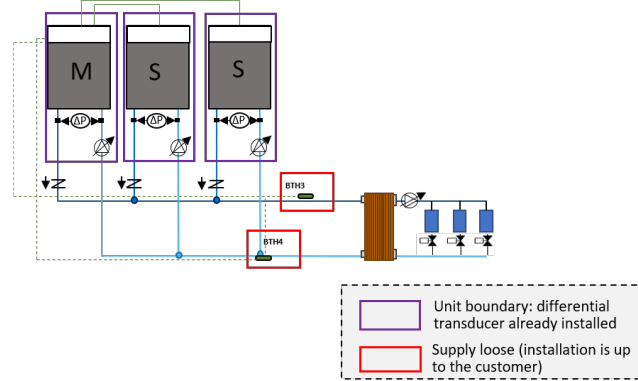

The HYZER E VPS with TD-based control function combines the Multilogic function, which is used to manage multi-machine systems, with the FLOWZER VPS with DT-based control control for variable flow systems.

It is obligatory for the option to be combined with the Flowzer VP (inverter) and with one of the hydraulic modules that can be selected for the unit.

The unit must include the advanced Bluethink controller, just one heat exchanger on the user side and a minimum capacity step of 25% or less.

Units operate according to the Master/Slave logic that is typical of a Multilogic system. For additional details, please refer to the FMx option.

VPS with DT-based control requires the installation on the machine of a differential transducer at the ends of the user-side heat exchanger in order to keep the flow rate in the system within a specific min. value allowed.

For additional details on the FLOWZER VPS with TD-based control logic, please refer to the dedicated FVPS with DT-based control option.

The networked units may be of different types, and the same observations as for the Multilogic option apply:

- if there are both chiller units and heat pumps in the network, the Master unit must obligatorily be one of the HP units;
- if there are both free-cooling and non free-cooling units in the network, the Master unit must obligatorily be one of the free-cooling units.

The HYZER E function requested with the unit can be:

- **HD0:** HYZER E VPS with TD-based control function for Slave units;
- **HD2:** HYZER E VPS with TD-based control function for the Master unit in order to manage up to 2 Slave units;
- **HD6:** HYZER E VPS with TD-based control function for the Master unit in order to manage up to 6 Slave units.

If you need to connect more than 6 slaves (up to 31), you can ask for a quotation from our sales department.

---

For the slave units, the accessory requires:

- programming of the unit as slave of a system of machines in Multilogic network

For the master units, the accessory requires:

- programming of the unit as master of a system of machines in Multilogic network
- entering of the parameters necessary for connection with the individual slave units
- installation in the electrical control panel of a network switch to allow the units to be connected in a LAN network.

The connection between the master unit and the slave units made with a CAT cable. 5E/UTP (prepared by the customer) with RJ45 connectors. Maximum cable length 100m.

For further details, please refer to the controller manual.

---

## Electrical accessories

---

### **A43N Power supply 400/3+N/50**

Power supply available in the following units: 12 - 18 - 24 - 30 - 36 - 45

### **A41N 415/3+N/50 power supply**

Power supply available in the following units: 12 - 18 - 24 - 30 - 36 - 45

### **A21 230/1/50 power supply**

Power supply available in the following units: 6 - 12

### **TERM Remote-controlled user terminal panel**

This accessory allows the terminal normally situated on the machine to be replicated on a support situated at a distance. It is particularly suitable when the unit is placed in an area that is not easily accessible.

The accessory is supplied loose and is to be installed by the customer at a maximum distance of 120m from the unit.

### **CP Single potential free operating contacts**

For units fitted with this accessory, there are clean contacts available on the terminal board inside the electrical box from which the customer can acquire signals that show the status of the unit's components (compressors, fans, pumps, alarms).

### **RMMT Maximum and minimum voltage relay**

This accessory constantly monitors the voltage value and the unit's power supply phase sequence. If the supply voltage does not fall within the set parameters or there is a phase reversal, an alarm is generated that stops the machine to prevent damage to its main parts

### **LIID Limitation of the current absorbed by digital input**

When this accessory is requested, a digital input is prepared in the terminal board to activate the forced capacity reduction of the unit to a set fixed level.

This accessory is useful when there is a need to necessarily limit the power absorbed by the unit as regards particular conditions.

We point out that, in some conditions (for example, during defrosting, oil return cycles or hourly compressor rotation procedures), the controller could force the unit to operate at full capacity for limited periods of time.

### **CSU Enabling for integration heater on user side**

The accessory enables management of a heat source outside the unit which is supplementary to the user circuit.

The necessary OK signals for controlling a maximum of four capacity steps are included in the electrical control panel. Activation of the steps takes place depending on the distance from the set heat pump set point.

### **CSS Enabling for integration heater on tap water side**

The accessory enables management of a heat source outside the unit which is supplementary to the domestic hot water circuit.

---

**AS Automatic management of domestic hot water**

This function enables the unit to control the temperature inside a domestic hot water storage tank and to manage a 3-way valve outside the unit (available as an accessory).

The water temperature in the domestic hot water tank is controlled through a dedicated probe situated in the tank.

Normally, the heat pump operates on the system to meet the comfort requirements of the building, but when the water temperature in the domestic hot water tank falls below a set threshold, the controller switches to domestic hot water production.

If the unit is operating as heat pump for heating, the 3-way valve will be switched and the set point changed. On the other hand, if the unit is producing chilled water for air conditioning, the controller switches the unit to heat pump mode, gives it the set point for domestic hot water and turns the 3-way valve to the appropriate position. Once the temperature in the domestic hot water tank has reached the set value, the unit automatically returns to producing water for the heating or air conditioning system.

When there is a defrost request, the 3-way valve is always forced to position itself on the system, whatever operating mode it may be in.

Domestic hot water production is always given priority.

With this accessory there are two digital inputs in the electrical control panel for respectively deactivating domestic hot water production and the production of water for the heating/air conditioning system.

When the unit is working in "domestic hot water only" mode, the pump is normally off and is switched on only for the time required to meet the demand for domestic hot water production.

When this accessory is fitted, the machine must have control of pump operation. This means that either the unit is equipped with one of the hydronic modules available in the catalogue (therefore with at least one pump installed on it) or the relay for external pump management must be requested as accessory.

The probe is used to measure the water temperature in the hottest part of the tank, so it must be positioned in a specially prepared pocket and secured using heat conducting paste. Installation by the customer.

The probe to be placed in the sanitary tank is supplied with a 12m long cable. The probe is used to measure the water temperature in the hottest part of the tank, so it must be positioned in a specially prepared pocket and secured using heat conducting paste. Installation by the customer.



## CSP Set point compensation depending on external air temperature

For units fitted with this accessory, the set point of the unit is set so that it can vary between two values, a maximum and a minimum, depending on the external air temperature. The compensation ramp and the maximum and minimum values of the set point can be changed by the user.

Unless otherwise specified in the order, the controller will be set to implement a positive compensation logic according to the temperatures shown in the following diagrams:

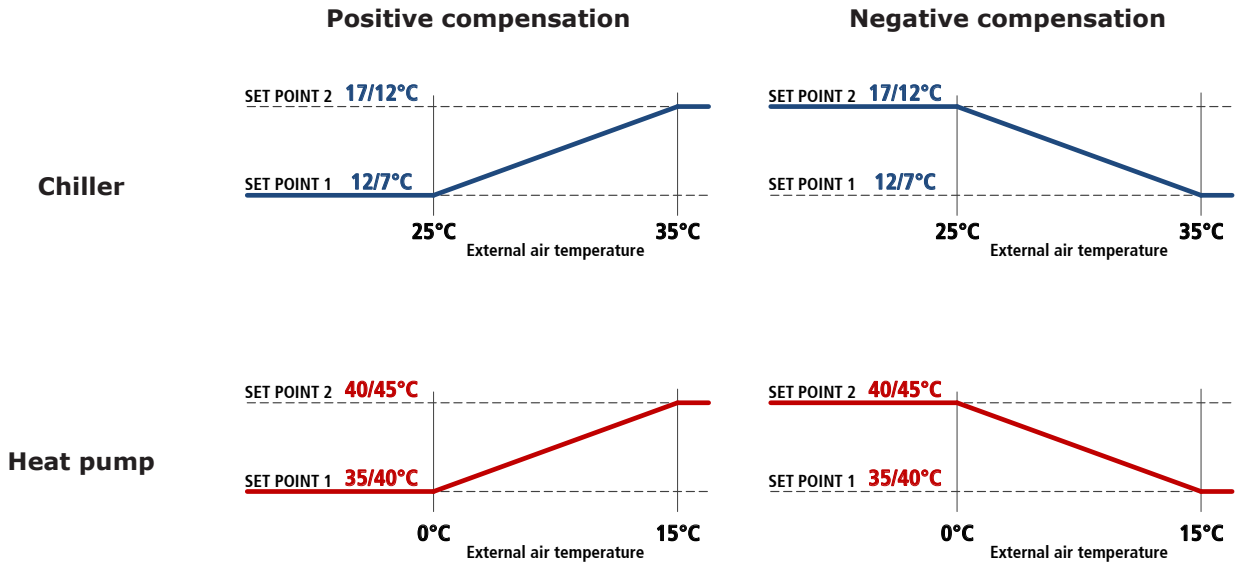

## SETD Double set point from digital input

The accessory allows you to preset two different operating set points and manage the change from one to the other through a digital signal.

The set point temperatures must be specified when ordering. For optimization of the unit, reference will be made to the lower set point in chiller mode and the higher set point in heat pump mode.

Unless otherwise specified in the order, the controller will be set at the factory with the following temperatures:

- in chiller mode, set point 1 to 7°C and set point 2 to 12°C
- in heat pump mode (only for HP units) set point 1 to 45°C and set point 2 to 40°C

## SETV Variable set point with remote signal

The accessory allows the set point to be varied continuously between two preset values, a maximum and a minimum, depending on an external signal that can be of the 0-1V, 0-10V or 4-20mA type.

The set point temperatures and the type of signal to use for the adjustment must be specified when ordering. For optimization of the unit, reference will be made to the lower set point in chiller mode and the higher set point in heat pump mode.

Unless otherwise specified in the order, the controller will be set at the factory with 0-10V analogue input and with the following temperatures:

- in chiller mode, 0V will correspond to a set point of 7°C and 10V will correspond to a set point of 12°C
- in heat pump mode (only for HP units), 0V will correspond to a set point of 45°C and 10V will correspond to a set point of 40°C

---

**RE1P Relay for management of 1 external pump**

This accessory can be requested for units without pumps and allows a pump outside the machine to be controlled.

**ARU Stopping of the unit due to temperatures below the operating limit**

With this accessory, it is possible to set the unit so that the controller switches off the compressors when the unit is operating in heat pump mode and the external air temperature falls below a minimum set limit: this will prevent the unit from going into low pressure alarm, so avoiding having to manually restart the machine. When the external air temperature returns above the set threshold temperature, the unit will automatically resume operation without it being necessary to do anything.

For units equipped with integrated pump, the pump will always be kept running so as to prevent ice formation and ensure correct reading of the temperature and antifreeze safety probes at all times.

The stopping temperature must be set based on the set point temperature and in accordance with what is allowed by the operating limits of the machine.

The same function can be used to set an external air temperature below which to use an alternative heat source because it is more efficient or economically more advantageous.

**NSS Night Shift System**

This accessory is applied to LC and LC/HP units combined with a remote condenser with speed adjuster (or EC fans) managed directly by the control of the internal unit.

In the day time band, which is normally the one with the highest heat load, priority is given to efficiency and therefore the machine works with a fan control curve that maximises the EER. So, in this time band, the unit is a high efficiency machine.

In the night time band (or in any case from the time band decided by the customer), the priority changes to limiting the noisiness of the machine and therefore the control carries out an adjustment of the control ramp of the condensing fans, thereby reducing the air flow rate and consequently the noise emission level. So, in this time band, the unit is a super low noise machine.

In any case, if there is a need for additional cooling capacity, the controller will manage the demand, if necessary, by accelerating the fans and keeping condensation within the correct operating limits.

The time slots can be set from the control depending on installation requirements.

When the unit is working in heat pump mode, in order to maximise the COP and to obtain the widest possible operating limits, the control of the unit forces the fans to the maximum speed also during the night time bands.

**SV3 Signal for 3-way modulating valve**

In the electrical control panel, a 0-10V output is preset to be used to control a 3-way modulating valve inserted on the hot circuit.

If the temperature of the water entering the hot exchanger is too low (for example, after the machine has been stopped for an extended period), through this signal, the controller of the unit will control the valve so as to recirculate part of the flow rate at the outlet and ensure that the unit always works within the operating limits.

The 3-way modulating valve is not included in this accessory, but can be requested as further accessory.

## Network accessories

### BEET Blueye® via Ethernet

**Blueye®** is a supervision platform that enables remote monitoring of one or more units in the same system interconnected through a network with Modbus protocol.

This accessory features the Blueeye device, as already installed and wired in the unit.

The critical variables to be monitored over time are identified for each connected device. These variables are sampled and saved to the cloud so that they are accessible at all times through a web portal or a mobile APP (available for Android and iOS).

The following options can be selected for connection to the internet:

- a LAN (Ethernet) connection - available in the system;
- a connection to a mobile network - at least 3G. The data SIM card is not included.

Three different types of contracts can be signed.

#### **Blueye® Cloud Basic:**

- to monitor a max. of 20 variables in total over max. 5 units/peripherals;
- to set a min. sampling frequency of 60 seconds.

#### **Blueye® Cloud Advanced:**

- to monitor a max. of 200 variables in total over max. 10 units/peripherals;
- to set a min. sampling frequency of 5 seconds.

#### **Blueye® Connect:**

- To monitor up to 10 units/peripherals.

Subscribing to any of the **Blueye® Cloud** enables:

- viewing the history of the monitored variables, in the form of both numerical values and graphs;
- downloading the history of variables in CSV format;
- the creation of automatic reports;
- setting notifications (via APP or mail) with settable thresholds for each variable;
- switching the unit ON/OFF remotely;;
- changing the set point remotely;
- selection of SUMMER/WINTER mode remotely (for reversible units only).

The subscription to the **Blueye® Connect** service offers the advantages below:

- a safe connection (tunnelling) between the user and the remote unit through the Blueye® portal;
- full access to the remote controller;
- real time monitoring;
- software upgrading.

**Blueye® via Ethernet** is only available for units supplied with an advanced controller and does not include any type of service. This service must be purchased separately based on the number of units/devices to be connected and the number of variables to be monitored. In order to connect multiple units to **Blueye® device, the network switch is required (this accessory is sold separately).**

Units can also be connected to the Blueeye device through the RS485 network featuring a Modbus RTU protocol (for this option, refer to BERS accessory).

For further details, refer to the specific Blueeye® documentation.

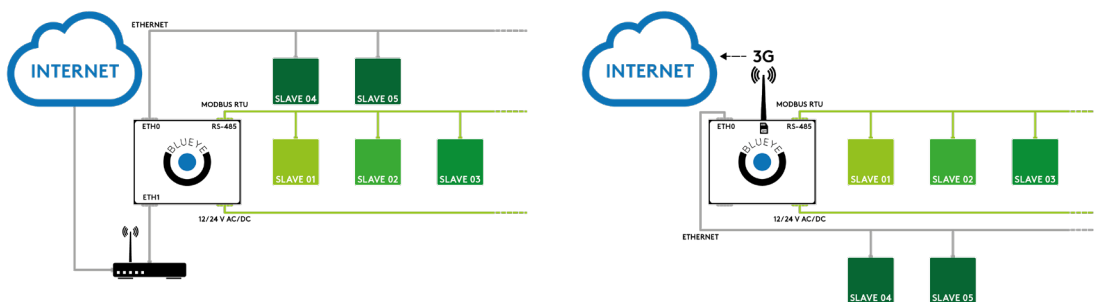

#### SW4P Network switch with 4 ports

The accessory includes installation in DIN rail of a professional 4-port network switch. Requires Blueeye via Ethernet.

#### WBS Webserver

The accessory enables the webserver function for remote display of the unit's main parameters.

#### FMx Multilogic Function

The Multilogic function allows management of up to 32 units equipped with advanced Bluethink controller and connected in hydraulic parallel with each other.

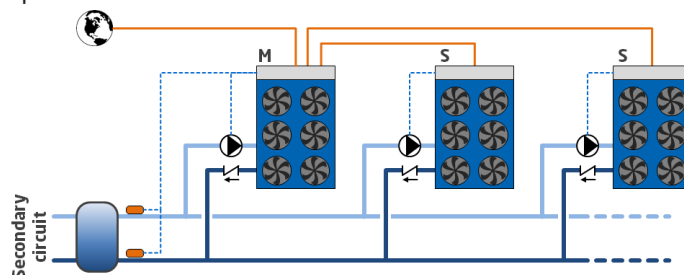

On the basis of the information recorded by the temperature probes installed on the delivery and return manifolds of the system, with the master unit, a capacity request is generated that is distributed among the units connected in the Multilogic network according to settable priority and optimization logics.

The connected units can be different from each other, in terms of capacity and set-up, provided the following rules are complied with:

If communication between the units fails or if the master is off-line, the slave units can continue to work according to the set thermoregulation parameters.

The connected units can be different from each other, in terms of capacity and set-up, provided the following rules are complied with:

- if there are both chiller units and heat pumps in the Multilogic network, the Master unit must obligatorily be one of the HP units
- if there are both free cooling and non free-cooling units in the Multilogic network, the Master unit must obligatorily be one of the free-cooling units.

The Multilogic function that can be requested with the unit can be:

- **FM0:** Multilogic function for Slave unit
- **FM2:** Multilogic function for Master unit for managing up to 2 Slaves
- **FM6:** Multilogic function for Master unit for managing up to 6 Slaves

If you need to connect more than 6 slaves (up to 31), you can ask for a quotation from our sales department.

For the slave units, the accessory requires:

- programming of the unit as slave of a system of machines in Multilogic network

For the master units, the accessory requires:

- programming of the unit as master of a system of machines in Multilogic network
- entering of the parameters necessary for connection with the individual slave units
- installation in the electrical control panel of a network switch to allow the units to be connected in a LAN network.
- the supply of 2 temperature probes to be positioned on the delivery and return manifold of the system (supplied separately with it, installation and wiring by the customer)

The connection between the master unit and the slave units made with a CAT cable. 5E/UTP (prepared by the customer) with RJ45 connectors. Maximum cable length 100m.

For further details, please refer to the controller manual.

---

**PSN SNMP protocol**

The accessory consists of a gateway that allows Ethernet connection to a SNMP manager supervision system. The use of this accessory causes the RS485 serial port to be unavailable.

**PBA BACnet protocol over IP (Ethernet)**

The controller is set for use, in read and write mode, of the BACnet port on IP protocol.

By default, the programming gives read-only access to the control of the unit. Reading / writing access is available on field with a service level.

**SMAR Smartlink function predisposition**

This accessory makes it possible to connect the controller of the unit with the controller of a Swegon GOLD™ air handling unit via a simple serial cable, so allowing their operating logics to be merged into a single consciousness that pursues the maximum energy efficiency of the system. The RS485 serial interface is already included and dedicated to connection with Swegon units.

The option is incompatible with:

- double set point
- variable set point with remote signal
- summer/winter selection by digital input
- set point compensation depending on external air temperature
- multilogic
- all communication protocols.

**SMAP Setup of Smartlink+ functions**

This option is used to connect the controller in the unit with the controller of a Swegon GOLD™ air handling unit via the Ethernet port TCP/IP, so allowing the operating logics of hydronic and ventilation systems to be merged into a single logic for the achievement of maximum energy efficiency and comfort. This option is only available for units featuring an advanced controller and it is compatible with Multilogic and Hyzer systems only if the machine is the Master.

The option is incompatible with:

- double set point
- variable set point with remote signal
- set point compensation depending on external air temperature
- all communication protocols.

---

## Other accessories

---

### **SCK Snow protection kit**

Painted sheet metal preventing the build-up of snow on the heat exchanger on the source side

### **AG Rubber anti-vibration mounts**

These allow you to reduce the vibrations transmitted from the unit to the surface it is standing on.  
Accessory supplied loose.

### **ALPR Pre-painted aluminium coil**

This option uses finned pack coils with copper tubes and pre-painted aluminium fins.

### **ANTC Coil treated with anti-corrosion paints**

The treatment is applied to the finned pack coils with copper pipes and aluminum fins and consists in the passivation of the aluminum with a polyurethane base through a procedure of immersion and then of a spray application of the coating that guarantees a double protection of the finning all over the exposure to the most aggressive environmental conditions even for more particular (or niche) process applications.

Specifically, the immersion process guarantees complete coverage of galvanic corrosion while the application of the spray protects the ends of the fins which represent the critical point for the initiation of the corrosion phenomenon.

The choice of whether or not to treat the exchanger should be made in relation to the environment in which the unit is to be installed and through observation of other structures and machinery with exposed metal surfaces present in the destination environment.

The cross observation criterion is the most valid method of selection currently available without having to carry out preliminary tests or measurements with instruments.

Protective treatment of the exchanger is strongly recommended if at least one of the points below is verified:

- there are obvious signs of corrosion on the exposed metal surfaces in the installation area
- the installation is located close to the sea coast
- the prevailing winds come from the sea and travel in the direction of the unit
- the environment is industrial with a significant concentration of pollutants
- it is an urban environment with a high population density
- it is a rural environment with the presence of organic discharges and effluents

For chiller units, this accessory also includes the "Cu/Al coil" accessory.

**With reference to the protection criteria to follow, especially for installations close to the coast, refer to the section titled "Installations that require the use of treated coils".**

### **GABB Packaging in wooden crate**

The unit is protected by a custom-made wooden cage, including a wooden sled designed for loading into containers and a fixing system. The accessory can be used for container shipping. Loading on containers must be carried out at the factory. The accessory is incompatible with "Skid for shipping in containers".

### **RAV Anti-freeze heater for condensate drip tray**

A heating cable, glued to the bottom, can be combined with the condensate drip tray to prevent ice formation at the base of the coil or near the drains.

The heater is controlled by a thermostat and is activated depending on the external air temperature.

Recommended accessory for installations in cold regions.

### **RETE Coil protection mesh with metal filter**

Coil protection mesh with hail-proof metal filter

# TECHNICAL SPECIFICATIONS

## EPSILON SKY Hi R7

			6	12	18	24	30	36	45
<b>Cooling</b>									
Refrigeration capacity	(1)	kW	7.02	10.47	18.36	22.32	30.53	36.76	42.93
Total absorbed power	(1)	kW	2.23	3.41	6.22	7.38	9.49	12.08	15.5
EER	(1)		3.15	3.07	2.95	3.02	3.22	3.04	2.77
<b>Compressors</b>									
Compressors/Circuits		n°	1/1						
Minimum capacity reduction step	(7)	%	26	24		30	24		20
Refrigerant charge CH (Cu/Al)	(3)	kg	1.5	2.4	2.8	3.85	4.2		4.4
<b>Fans</b>									
Quantity		n°	1	2	1	2			
Total air flow CH		m³/h	5408	6324	9199	10050	18370	18330	18320
<b>User-side heat exchanger</b>									
Quantity		n°	1						
Water flow rate CH	(1)	m³/h	1.21	1.8	3.16	3.85	5.26	6.33	7.39
Pressure drop CH	(1)	kPa	16.5	12.4	14.6	18.5	21.5	31.2	13
<b>Noise levels</b>									
Sound power level cooling	(4)	dB(A)	72		73	75	77	80	83
Sound pressure level cooling	(6)	dB(A)	41		42	44	46	49	52
<b>Dimensions and weights**</b>									
Length		mm	936		1116	1309	1804		
Depth		mm	588	487	751	717	751		
Height		mm	1370			1585	1611		
Operating weight		kg	123	130	229	246	298	311	313

(1) External air temperature of 35°C and user-side heat exchanger water inlet-outlet temperature of 12-7°C. Values compliant with standard EN 14511

(2) Outside air temperature 7°C DB, 6°C WB; condenser inlet/outlet water temperature 40/45°C. Values compliant with standard EN 14511

(3) The indicated refrigerant charge is calculated. The refrigerant charge can vary according to different versions/accessories and product updates.

(4) Unit operating at rated capacity, with no accessories of any kind - external air temperature 35°C and water input/output temperature from/to heat exchanger and user equal to 12/7°C. Values taken by measurements made in accordance with standard ISO 3744 and the Eurovent certification programme, where applicable. Binding values See NOISE LEVELS section.

(5) unit operating at nominal operating capacity, with no accessories of any kind, with external air temperature of 7°C (6°C WB) and user-side heat exchanger water inlet/outlet temperature of 40/45°C. Values obtained from measurements carried out in accordance with standard ISO 3744.

(6) Values obtained from the sound power level (conditions: note 4), related to a distance of 10 m from the unit in free field with directivity factor Q=2. Non-binding values See NOISE LEVELS section.

(7) Approximate value. The minimum capacity reached by the unit depends on the operating conditions. The value shown may not be suitable for calculating the minimum volume of water: to do this, consult the "Minimum water content in the system" section.

\*\* Basic unit without included accessories

## EPSILON SKY Hi HP R7 [R32]

			6	12	18	24	30	36	45
<b>Cooling</b>									
Refrigeration capacity	(1)	kW	6.95	10.37	18.18	22.1	30.23	36.4	42.5
Total absorbed power	(1)	kW	2.23	3.41	6.22	7.38	9.49	12.08	15.5
EER	(1)		3.12	3.04	2.92	2.99	3.19	3.01	2.74
<b>Heating</b>									
Heating capacity	(1)	kW	7.32	11.61	19.46	23.51	31.55	38.41	45.04
Total absorbed power	(1)	kW	2.27	3.42	6	7.32	9.4	11.66	14.75
COP	(1)		3.23	3.39	3.24	3.21	3.36	3.29	3.05
<b>Compressors</b>									
Compressors/Circuits		n°	1/1	1/1	1/1	1/1	1/1	1/1	1/1
Minimum capacity reduction step	(7)	%	26	24	24	30	24	24	20
Refrigerant charge HP	(3)	kg	1.5	2.4	2.8	3.85	4.2	4.2	4.4
<b>Fans</b>									
Quantity		n°	1	2	1	2	2	2	2
Total air flow rate HP		m³/h	5527	6625	9505	10490	18880	18890	18740
<b>User-side heat exchanger</b>									
Quantity		n°	1	1	1	1	1	1	1
Water flow rate CH	(1)	m³/h	1.2	1.79	3.13	3.81	5.21	6.27	7.32
Pressure drop CH	(1)	kPa	16.5	12.4	14.6	18.5	21.5	31.2	13
Water flow rate HP	(2)	m³/h	1.25	1.99	3.34	4.04	5.42	6.59	7.73
Pressure drop HP	(2)	kPa	17.9	14.5	16.1	20.1	22.7	32.2	20.7
<b>Noise levels</b>									
Sound power level cooling	(4)	dB(A)	72	72	73	75	77	80	83
Sound pressure level cooling	(6)	dB(A)	41	41	42	44	46	49	52
<b>Dimensions and weights**</b>									
Length		mm	936	936	1116	1309	1804	1804	1804
Depth		mm	588	487	751	717	751	751	751
Height		mm	1370	1370	1370	1585	1611	1611	1611
Operating weight		kg	131	138	239	257	310	323	330

(1) External air temperature of 35°C and user-side heat exchanger water inlet-outlet temperature of 12-7°C. Values compliant with standard EN 14511

(2) Outside air temperature 7°C DB, 6°C WB; condenser inlet/outlet water temperature 40/45°C. Values compliant with standard EN 14511

(3) Theoretical values referred to the basic unit. The amount of gas actually charged in the unit may differ.

(4) Unit operating at rated capacity, with no accessories of any kind - external air temperature 35°C and water input/output temperature from/to heat exchanger and user equal to 12/7°C. Values taken by measurements made in accordance with standard ISO 3744 and the Eurovent certification programme, where applicable. Binding values See NOISE LEVELS section.

(5) unit operating at nominal operating capacity, with no accessories of any kind, with external air temperature of 7°C (6°C WB) and user-side heat exchanger water inlet/outlet temperature of 40/45°C. Values obtained from measurements carried out in accordance with standard ISO 3744.

(6) Values obtained from the sound power level (conditions: note 4), related to a distance of 10 m from the unit in free field with directivity factor Q=2. Non-binding values See NOISE LEVELS section.

(7) Approximate value. The minimum capacity reached by the unit depends on the operating conditions. The value shown may not be suitable for calculating the minimum volume of water: to do this, consult the "Minimum water content in the system" section.

\*\* Basic unit without included accessories



## EPSILON SKY HP R7 [R32]

			18	24	30	36	45
<b>Cooling</b>							
Refrigeration capacity	(1)	kW	17.1	21.3	26.02	28.7	36.2
Total absorbed power	(1)	kW	6.17	7.39	8.73	10.15	13.52
EER	(1)		2.77	2.88	2.98	2.83	2.68
<b>Heating</b>							
Heating capacity	(1)	kW	19.9	24.5	30.3	33.6	42.5
Total absorbed power	(1)	kW	6.14	7.41	9.07	10.2	13.32
COP	(1)		3.24	3.31	3.34	3.29	3.19
<b>Compressors</b>							
Compressors/Circuits		n°	1/1				
Minimum capacity reduction step	(7)	%	100				
Refrigerant charge HP	(3)	kg	2.8	3.85	4.2		4.4
<b>Fans</b>							
Quantity		n°	1		2		
Total air flow rate HP		m³/h	9505	10490	18880	18890	18740
<b>User-side heat exchanger</b>							
Quantity		n°	1				
Water flow rate CH	(1)	m³/h	2.56	3.32	4.48	4.9	6.2
Pressure drop CH	(1)	kPa	11.1	14.7	18.5	22.1	11.7
Water flow rate HP	(2)	m³/h	2.99	3.78	5.21	5.78	7.31
Pressure drop HP	(2)	kPa	13.2	17.2	20.4	24.8	17.7
<b>Noise levels</b>							
Sound power level cooling	(4)	dB(A)	73	75	77	80	85
Sound pressure level cooling	(6)	dB(A)	42	44	46	49	54
<b>Dimensions and weights**</b>							
Length		mm	1116	1309	1804		
Depth		mm	751	717	751		
Height		mm	1370	1585	1611		
Operating weight		kg	234	251	305	313	320

- (1) External air temperature of 35°C and user-side heat exchanger water inlet-outlet temperature of 12-7°C. Values compliant with standard EN 14511
- (2) Outside air temperature 7°C DB, 6°C WB; condenser inlet/outlet water temperature 40/45°C. Values compliant with standard EN 14511
- (3) Theoretical values referred to the basic unit. The amount of gas actually charged in the unit may differ.
- (4) Unit operating at rated capacity, with no accessories of any kind - external air temperature 35°C and water input/output temperature from/to heat exchanger and user equal to 12/7°C. Values taken by measurements made in accordance with standard ISO 3744 and the Eurovent certification programme, where applicable. Binding values See NOISE LEVELS section.
- (5) unit operating at nominal operating capacity, with no accessories of any kind, with external air temperature of 7°C (6°C WB) and user-side heat exchanger water inlet/outlet temperature of 40/45°C. Values obtained from measurements carried out in accordance with standard ISO 3744.
- (6) Values obtained from the sound power level (conditions: note 4), related to a distance of 10 m from the unit in free field with directivity factor Q=2. Non-binding values See NOISE LEVELS section.
- (7) Approximate value. The minimum capacity reached by the unit depends on the operating conditions. The value shown may not be suitable for calculating the minimum volume of water: to do this, consult the "Minimum water content in the system" section.
- \*\* Basic unit without included accessories

## EPSILON SKY Hi LE R7

			6	12	18	24	30	36	45
<b>Cooling</b>									
Refrigeration capacity	(1)	kW	7.75	11.62	19.8	24.95	33.23	37.88	46.66
Total absorbed power	(1)	kW	2.32	3.63	6.15	7.58	10.26	12.11	16.41
EER	(1)		3.35	3.2	3.22	3.29	3.24	3.13	2.84
<b>Compressors</b>									
Compressors/Circuits		n°	1/1						
Minimum capacity reduction step	(7)	%	26	24		30	24		20
Refrigerant charge CH (Cu/Al)	(3)	kg	1.7	2.6	3.1	4.2	4.6		4.8
<b>Fans</b>									
Quantity		n°	1	2	1	2			
Total air flow CH		m³/h	5408	6324	9199	10050	18370	18330	18320
<b>Noise levels</b>									
Sound power level cooling	(4)	dB(A)	72		73	75	77	80	83
Sound pressure level cooling	(6)	dB(A)	41		42	44	46	49	52
<b>Dimensions and weights**</b>									
Length		mm	936		1116	1309	1804		
Depth		mm	588	487	751	717	751		
Height		mm	1370			1585	1611		
Operating weight		kg	118	125	219	235	286	296	

Partly completed machinery: conformity with Ecodesign depends on the combination with the remote heat exchanger. CE marked units.

(1) External air temperature 35°C, evaporating temperature 7,5°C.

(2) External air temperature 7°C DB, 6°C WB, condensing temperature 40°C.

(3) Theoretical values referred to the basic unit. The amount of gas actually charged in the unit may differ.

(4) unit operating at nominal operating capacity, without any accessories, with external air temperature of 35°C and evaporating temperature 7.5°C. Binding values. Values obtained from measures taken according to standard ISO 3744 and to the Eurovent certification programme where applicable.

(5) unit operating at nominal operating capacity, without any accessories, with external air temperature of 7°C (6°C wb) and condensing temperature 40°C. Values obtained from measures taken according to standard ISO 3744.

(6) Values obtained from the sound power level (conditions: note 4), related to a distance of 10 m from the unit in free field with directivity factor Q=2. Non-binding values See NOISE LEVELS section.

(7) Approximate value. The minimum capacity reached by the unit depends on the operating conditions. The value shown may not be suitable for calculating the minimum volume of water: to do this, consult the "Minimum water content in the system" section.

\*\* Basic unit without included accessories

## EPSILON SKY Hi HP LE R7 [R32]

			6	12	18	24	30	36	45
<b>Cooling</b>									
Refrigeration capacity	(1)	kW	7.67	11.5	19.6	24.7	32.9	37.5	46.2
Total absorbed power	(1)	kW	2.32	3.63	6.15	7.58	10.26	12.11	16.41
EER	(1)		3.31	3.17	3.19	3.26	3.21	3.1	2.82
<b>Heating</b>									
Heating capacity	(2)	kW	7.05	11	19	23.6	32	36.5	44.9
Total absorbed power	(2)	kW	1.87	3.02	5.2	6.16	8.86	9.78	12.72
COP	(2)		3.77	3.64	3.65	3.83	3.61	3.73	3.53
<b>Compressors</b>									
Compressors/Circuits		n°	1/1	1/1	1/1	1/1	1/1	1/1	1/1
Minimum capacity reduction step	(7)	%	26	24	24	30	24	24	20
Refrigerant charge HP	(3)	kg	1.7	2.6	3.1	4.2	4.6	4.6	4.8
<b>Fans</b>									
Quantity		n°	1	2	1	2	2	2	2
Total air flow rate HP		m³/h	5527	6625	9505	10490	18880	18890	18740
<b>Noise levels</b>									
Sound power level cooling	(4)	dB(A)	72	72	73	75	77	80	83
Sound pressure level cooling	(6)	dB(A)	41	41	42	44	46	49	52
<b>Dimensions and weights**</b>									
Length		mm	936	936	1116	1309	1804	1804	1804
Depth		mm	588	487	751	717	751	751	751
Height		mm	1370	1370	1370	1585	1611	1611	1611
Operating weight		kg	126	133	229	246	298	308	313

Partly completed machinery: conformity with Ecodesign depends on the combination with the remote heat exchanger. CE marked units.

(1) External air temperature 35°C, evaporating temperature 7,5°C.

(2) External air temperature 7°C DB, 6°C WB, condensing temperature 40°C.

(3) Theoretical values referred to the basic unit. The amount of gas actually charged in the unit may differ.

(4) unit operating at nominal operating capacity, without any accessories, with external air temperature of 35°C and evaporating temperature 7.5°C. Binding values. Values obtained from measures taken according to standard ISO 3744 and to the Eurovent certification programme where applicable.

(5) unit operating at nominal operating capacity, without any accessories, with external air temperature of 7°C (6°C wb) and condensing temperature 40°C. Values obtained from measures taken according to standard ISO 3744.

(6) Values obtained from the sound power level (conditions: note 4), related to a distance of 10 m from the unit in free field with directivity factor Q=2. Non-binding values See NOISE LEVELS section.

(7) Approximate value. The minimum capacity reached by the unit depends on the operating conditions. The value shown may not be suitable for calculating the minimum volume of water: to do this, consult the "Minimum water content in the system" section.

\*\* Basic unit without included accessories

# ECODESIGN

## INTRODUCTION

The Ecodesign/ErP Directive (2009/125/EC) lays down new standards for more efficient energy use.

The Directive contains various regulations; as regards chiller products and heat pumps, the regulations of interest are the following:

- Regulation 2013/813, for small heat pumps ( $P_{\text{design}} \leq 400$  kW)
- Regulation 2016/2281, for chillers and heat pumps with  $P_{\text{design}} > 400$  kW
- Regulation 2013/811, for heat pumps with  $P_{\text{design}} \leq 70$  kW.

The last-mentioned regulation (2013/811) regards the labelling (Ecolabel certification) of small heat pumps.

The other two regulations (2013/813 and 2016/2281) set seasonal efficiency targets that the products must comply with to be sold and installed in the European Union (essential requirement for CE marking).

These efficiency limits are defined through ratios, which are respectively:

- $\eta_{\text{sh}}$  (SCOP), with reference to regulation 2013/813
- $\eta_{\text{sc}}$  (SEER) for comfort applications and SEPR for process applications, with reference to regulation 2016/2281.

As regards regulation 2016/2281, with effect from 1st January 2021, the required minimum efficiency limit will be raised (Tier 2) from the current threshold (Tier 1).

The figure below schematically illustrates the correspondence between product and reference energy ratio.

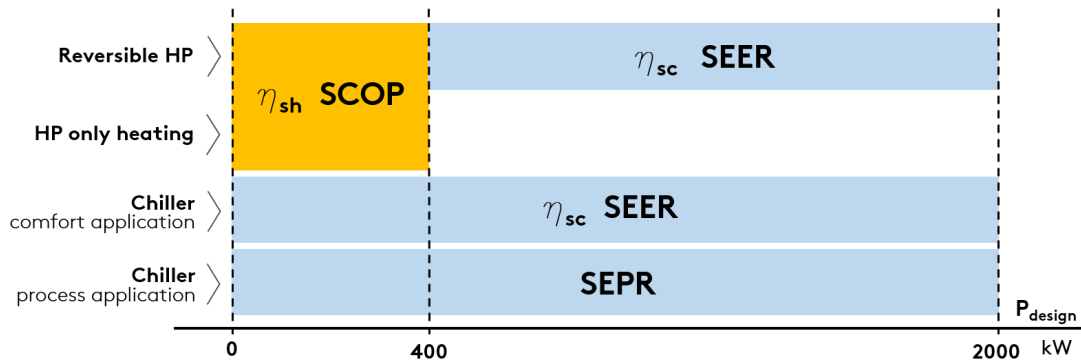

Some notes and clarifications:

For comfort applications, regulation 2016/2281 sets the  $\eta_{\text{sc}}$  (SEER) ratio in two different operating conditions:

- SEER calculated with machine inlet/outlet water temperature of 12/7°C (low temperature application),
- SEER calculated with machine inlet/outlet water temperature of 23/18°C (medium temperature application).

The minimum efficiency requirement is the same, but can be met at condition 12/7°C or at condition 23/18°C, depending on the application envisaged for the machine.

Regulation 2013/813 distinguishes two different types: at low temperature and at medium temperature.

The following refer to the application at low temperature: (low temperature application) all heat pumps whose maximum delivery temperature for heating purposes is lower than 52°C with source at temperature of -7°C and -8°C wet bulb (air-water unit) or inlet 10°C (water-water unit), at the reference design conditions for an average climate. For these, the efficiency ratio is "low temperature application" (outlet water temperature 35°C).

For all the other heat pumps, the efficiency ratio is related to "medium temperature application" (outlet water temperature 55°C).

The ratios must be calculated according to the reference European heating season in average climatic conditions.

The minimum efficiency requirements set by the regulations are indicated below.

REGULATION 2016/2281, comfort application

TYPE OF UNIT		MINIMUM REQUIREMENT			
		Tier 1		Tier 2 (2021)	
SOURCE	P <sub>design</sub>	η <sub>sc</sub> [%]	SEER	η <sub>sc</sub> [%]	SEER
air	< 400kW	149	3,8	161	4,1
air	≥ 400kW	161	4,1	179	4,55
water	< 400kW	196	4,975	200	5,075
water	≥ 400kW and < 1500kW	227	5,75	252	6,375
water	≥ 1500kW	245	6,2	272	6,875

REGULATION 2016/2281, process application

TYPE OF UNIT		MINIMUM REQUIREMENT	
		Tier 1	Tier 2 (2021)
SOURCE	P <sub>design</sub>	SEPR	SEPR
air	< 400kW	4,5	5
air	≥ 400kW	5	5,5
water	< 400kW	6,5	7
water	≥ 400kW and < 1500kW	7,5	8
water	≥ 1500kW	8	8,5

REGULATION 2013/813

SOURCE	APPLICATION	MINIMUM REQUIREMENT	
		η <sub>sh</sub> [%]	SCOP
air	low temperature application	125	3,2
water	low temperature application	125	3,325
air	medium temperature application	110	2,825
water	medium temperature application	110	2,95

The conformity of the product must be checked according to the type of application, whether comfort or process, and at the required outlet water temperature.

The two schematic tables below, respectively for comfort application and for process application, indicate the reference of the required conformity according to the type of product and the set point temperature (reference to regulations 2016/2281 and 2013/813).

Important note: for mixed comfort and process applications, the reference application for conformity is the comfort application.

#### COMFORT APPLICATION

PRODUCT	OUTLET WATER TEMPERATURE	COMPLIANCE INDEX	REGULATION
<b>Chiller</b>	< 18°C	SEER/ηsc low temperature application	2016/2281
	≥ 18°C	SEER/ηsc medium temperature application	2016/2281
<b>Heat pumps (reversible and only heating) Pdesign≤400kW</b>		SCOP/ηsh	2013/813
<b>Reversible heat pumps Pdesign&gt;400kW</b>	< 18°C	SEER/ηsc low temperature application	2016/2281
	≥ 18°C	SEER/ηsc medium temperature application	2016/2281
<b>Heat pumps only heating Pdesign&gt;400kW</b>		-	-

- = exemption from Ecodesign

#### PROCESS APPLICATION

PRODUCT	OUTLET WATER TEMPERATURE	COMPLIANCE INDEX	REGULATION
<b>Chiller</b>	≥ +2°C , ≤ 12°C	SEPR	2016/2281
	> 12°C	-	-
	> -8°C , < +2°C	-	-

- = exemption from Ecodesign

Some specifications and notes follow.

#### **EC fans:**

The only option that positively affects the performance of the unit, by increasing its seasonal energy efficiency ratio, is the VEC accessory.

A unit equipped with EC fans has a higher SEER (ηsc) than the configuration with standard fans.

## EPSILON SKY RANGE

With reference to the EPSILON Sky range, below is a list of concerned regulations relating to the different units in their various configurations:

- chiller version: regulation 2016/2281
- HP version: regulation 2013/813 (since they are all units with Pdesign ≤ 400 kW).

The tables below give information on the conformity of the units and the seasonal energy performance ratios with regard to the reference regulation.

### EPSILON SKY Hi R7 [R32]

			6	12	18	24	30	36	45
<b>REGULATION 2016-2281</b>									
Pdesign	(1)	kW	-	-	-	-	-	-	-
<b>COMFORT</b>									
<b>Standard Unit</b>									
ηsc	(1)	%	163	187	168.2	195	191	184.6	178.2
SEER	(1)		4.15	4.75	4.28	4.95	4.85	4.69	4.53
Compliance Tier 2 (2021)	(1)		Y	Y	Y	Y	Y	Y	Y
<b>Unit with EC fans (VEC)</b>									
ηsc	(1)	%	169.8	200.6	183	204.2	209	198.6	189.8
SEER	(1)		4.32	5.09	4.65	5.18	5.3	5.04	4.82
Compliance Tier 2 (2021)	(1)		Y	Y	Y	Y	Y	Y	Y

Y = unit in compliance with Ecodesign at the indicated condition. N = unit not in compliance with Ecodesign at the indicated condition: it can be installed only in non-EU countries.

(1) User-side heat exchanger water inlet/outlet temperature 12/7°C (low temperature application), with reference to regulation 2016/2281 and standard EN 14825.

## EPSILON SKY Hi HP R7 [R32]

			6	12	18	24	30	36	45
<b>REGULATION 2013/813</b>			-						
Pdesign	(1)	kw	5.2	8.4	14.1	17.1	22.3	27.2	32
<b>COMFORT</b>									
<b>Standard Unit</b>									
ηsh	(1)	%	171	174.6	170.2	164.6	166.6	169.8	164.2
SCOP	(1)		4.35	4.44	4.33	4.19	4.24	4.32	4.18
<b>Standard Unit</b>									
ηsh	(3)	%	140.7	122.3	141	128.6	135.9	139.1	134.3
SCOP MT	(3)		3.59	3.51	3.6	3.29	3.47	3.55	3.43
<b>Unit with EC fans (VEC)</b>									
ηsh	(1)	%	193.4	189	203.8	193.8	204.6	195	183
SCOP	(1)		4.91	4.8	5.17	4.92	5.19	4.95	4.65
<b>Unit with EC fans (VEC)</b>									
ηsh	(3)	%	156	146.8	162.5	148.8	159.5	156.2	147.7
SCOP MT	(3)		3.98	3.75	4.14	3.8	4.06	3.98	3.77
<b>REGULATION 2013/811</b>			-						
<b>Standard Unit</b>									
Ecolabel	(2)		A++						
<b>Unit with EC fans (VEC)</b>									
Ecolabel	(2)		A+++						

Y = unit in compliance with Ecodesign at the indicated condition. N = unit not in compliance with Ecodesign at the indicated condition: it can be installed only in non-EU countries.

- (1) User-side heat exchanger water inlet/outlet temperature 30/35°C, Average climate profile, with reference to regulation 2013/813 and norm EN 14825.
- (2) Energy efficiency class with reference to regulation 2013/811 (low temperature applications).
- (3) User-side heat exchanger water inlet/outlet temperature 47/55°C, Average climate profile, with reference to regulation 2013/813 and norm EN 14825.

## EPSILON SKY HP R7 [R32]

			18	24	30	36	45
<b>REGULATION 2013/813</b>			-				
Pdesign	(1)	kw	21.7	26.5	34.2	37.2	46.8
<b>COMFORT</b>							
<b>Standard Unit</b>							
ηsh	(1)	%	129	128.6	133.4	128.6	125.8
SCOP	(1)		3.3	3.29	3.41	3.29	3.22
<b>REGULATION 2013/811</b>			-				
<b>Standard Unit</b>							
Ecolabel	(2)		A+				

Y = unit in compliance with Ecodesign at the indicated condition. N = unit not in compliance with Ecodesign at the indicated condition: it can be installed only in non-EU countries.

- (1) User-side heat exchanger water inlet/outlet temperature 30/35°C, Average climate profile, with reference to regulation 2013/813 and norm EN 14825.
- (2) Energy efficiency class with reference to regulation 2013/811 (low temperature applications).



# ELECTRICAL SPECIFICATIONS

## EPSILON SKY Hi R7 [R32]

			6	12	18	24	30	36	45
<b>General electrical specifications</b>									
Max. absorbed power (FLI)	(1)	kW	4	10.7	11.1	14.4	15.2	25.2	25.2
Max. absorbed current (FLA)	(1)	A	16.9	19	20.6	25.9	29.2	45.2	45.2
Nominal current (Inom)	(2)	A	10.5	5.4	9.8	11.6	14.9	19	24.4
cosφ standard unit	(2)		0.92	0.92	0.92	0.92	0.92	0.92	0.92
Maximum inrush current (MIC)	(3)	A	-	-	-	-	-	-	-
Power supply		V/ph/Hz	230/1~/50	400/3~+N/50	400/3~+N/50	400/3~+N/50	400/3~+N/50	400/3~+N/50	400/3~+N/50
Power supply for auxiliary circuits		V/ph/Hz	230- 24/1~/50	230- 24/1~/50	230- 24/1~/50	230- 24/1~/50	230- 24/1~/50	230- 24/1~/50	230- 24/1~/50
Suggested line section	(5)	mm <sup>2</sup>	3G4 FG16OR16	5G4 FG16OR16	5G6 FG16OR16	5G6 FG16OR16	5G6 FG16OR16	5G16 FG16OR16	5G16 FG16OR16
Suggested line protection	(6)		CH10gG 25A		CH14gG 32A	CH14gG 40A		NH00gG 63A	
<b>Electrical specifications for fans</b>									
Rated power of standard fan	(1)	n° x kW	1 x 0,22	2 x 0,115	1 x 0,6	2 x 0,22	2 x 0,6	2 x 0,6	2 x 0,6
Rated current of standard fan	(1)	n° x A	1 x 0,97	2 x 0,51	1 x 2,62	2 x 0,97	2 x 2,62	2 x 2,62	2 x 2,62
Rated power of EC fan	(2)	n° x kW	1 x 0,12	2 x 0,11	1 x 0,26	2 x 0,13	2 x 0,25	2 x 0,28	2 x 0,58
Rated current of EC fan	(2)	n° x A	1 x 0,55	2 x 0,48	1 x 1,19	2 x 0,6	2 x 1,11	2 x 1,3	2 x 2,53

## EPSILON SKY Hi HP R7 [R32]

			6	12	18	24	30	36	45
<b>General electrical specifications</b>									
Max. absorbed power (FLI)	(1)	kW	4	10.7	11.1	14.4	15.2	25.2	25.2
Max. absorbed current	(1)	A	16.9	19	20.6	25.9	29.2	45.2	45.2
Nominal current (Inom)	(2)	A	10.5	5.4	9.8	11.6	14.9	19	24.4
cosφ standard unit	(2)		0.92	0.92	0.92	0.92	0.92	0.92	0.92
Maximum inrush current (MIC)	(3)	A	-	-	-	-	-	-	-
Power supply		V/ph/Hz	230/1~/50	400/3~+N/50	400/3~+N/50	400/3~+N/50	400/3~+N/50	400/3~+N/50	400/3~+N/50
Power supply for auxiliary circuits		V/ph/Hz	230- 24/1~/50	230- 24/1~/50	230- 24/1~/50	230- 24/1~/50	230- 24/1~/50	230- 24/1~/50	230- 24/1~/50
Suggested line section	(5)	mm <sup>2</sup>	3G4 FG16OR16	5G4 FG16OR16	5G6 FG16OR16	5G6 FG16OR16	5G6 FG16OR16	5G16 FG16OR16	5G16 FG16OR16
Suggested line protection	(6)		CH10gG 25A		CH14gG 32A	CH14gG 40A		NH00gG 63A	
<b>Electrical specifications for fans</b>									
Rated power of standard fan	(1)	n° x kW	1 x 0,22	2 x 0,115	1 x 0,6	2 x 0,22	2 x 0,6	2 x 0,6	2 x 0,6
Rated current of standard fan	(1)	n° x A	1 x 0,97	2 x 0,51	1 x 2,62	2 x 0,97	2 x 2,62	2 x 2,62	2 x 2,62
Rated power of EC fan	(2)	n° x kW	1 x 0,12	2 x 0,11	1 x 0,26	2 x 0,13	2 x 0,25	2 x 0,28	2 x 0,58
Rated current of EC fan	(2)	n° x A	1 x 0,55	2 x 0,48	1 x 1,19	2 x 0,6	2 x 1,11	2 x 1,3	2 x 2,53

(1) Data regarding the unit without accessories working in maximum power absorption conditions

(2) Datum related to the unit without accessories working in standard conditions (A35°C; W12-7°C)

(3) Maximum effective RMS value of the current when the last compressor starts (FLA of the entire unit - FLA of the largest compressor + LRA of the largest compressor)

(4) Maximum effective RMS value of the current when the last compressor starts (FLA of the entire unit - FLA of the largest compressor + 0.6 x LRA of the largest compressor)

(5) These values are determined for cables with operating temperature of 40°C, EPR insulation and a line with a maximum length of 50m. The line section must be determined by a qualified technician based on the protection devices, the length of the line, the type of cable used and the type of installation.

(6) The correct line protection part must be determined by a qualified technician based on the length of the line, the type of cable used and the type of installation.

## EPSILON SKY HP R7 [R32]

			18	24	30	36	45
<b>General electrical specifications</b>							
Max. absorbed power (FLI)	(1)	kW	8.4	9.3	12.7	14.3	18.8
Max. absorbed current	(1)	A	16	16.5	24.7	27.4	35
Nominal current (Inom)	(2)	A	11.1	13.3	15.8	18.3	24.4
cosφ standard unit	(2)		0.8	0.8	0.8	0.8	0.8
Maximum inrush current (MIC)	(3)	A	87	98	148	160	199
Power supply		V/ph/Hz	400/3~+N/50	400/3~+N/50	400/3~+N/50	400/3~+N/50	400/3~+N/50
Power supply for auxiliary circuits		V/ph/Hz	230-24/1~/50	230-24/1~/50	230-24/1~/50	230-24/1~/50	230-24/1~/50
Suggested line section	(5)	mm <sup>2</sup>	5G4 FG16OR16	5G6 FG16OR16	5G6 FG16OR16	5G6 FG16OR16	5G10 FG16OR16
Suggested line protection	(6)		CH10gG 25A	CH14gG 32A		CH14gG 40A	NH00gG 50A
<b>Electrical specifications for fans</b>							
Rated power of standard fan	(1)	n° x kW	1 x 0,6	2 x 0,22	2 x 0,6	2 x 0,6	2 x 0,6
Rated current of standard fan	(1)	n° x A	1 x 2,62	2 x 0,97	2 x 2,62	2 x 2,62	2 x 2,62

- (1) Data regarding the unit without accessories working in maximum power absorption conditions  
(2) Datum related to the unit without accessories working in standard conditions (A35°C; W12-7°C)  
(3) Maximum effective RMS value of the current when the last compressor starts (FLA of the entire unit - FLA of the largest compressor + LRA of the largest compressor)  
(4) Maximum effective RMS value of the current when the last compressor starts (FLA of the entire unit - FLA of the largest compressor + 0.6 x LRA of the largest compressor)  
(5) These values are determined for cables with operating temperature of 40°C, EPR insulation and a line with a maximum length of 50m. The line section must be determined by a qualified technician based on the protection devices, the length of the line, the type of cable used and the type of installation.  
(6) The correct line protection part must be determined by a qualified technician based on the length of the line, the type of cable used and the type of installation.

## EPSILON SKY Hi LE R7 [R32]

			6	12	18	24	30	36	45
<b>General electrical specifications</b>									
Max. absorbed power (FLI)	(1)	kW	4	10.7	11.1	14.4	15.2	25.2	25.2
Max. absorbed current	(1)	A	17	19	20.6	25.9	29.2	45.2	45.2
Nominal current (Inom)	(2)	A	11	5.7	9.7	11.9	16.1	19	25.7
cosφ standard unit	(2)		0.92	0.92	0.92	0.92	0.92	0.92	0.92
Maximum inrush current (MIC)	(3)	A	-	-	-	-	-	-	-
Power supply		V/ph/Hz	230/1~/50	400/3~+N/50	400/3~+N/50	400/3~+N/50	400/3~+N/50	400/3~+N/50	400/3~+N/50
Power supply for auxiliary circuits		V/ph/Hz	230- 24/1~/50	230- 24/1~/50	230- 24/1~/50	230- 24/1~/50	230- 24/1~/50	230- 24/1~/50	230- 24/1~/50
Suggested line section	(5)	mm <sup>2</sup>	3G4 FG16OR16	5G4 FG16OR16	5G6 FG16OR16	5G6 FG16OR16	5G6 FG16OR16	5G16 FG16OR16	5G16 FG16OR16
Suggested line protection	(6)		CH10gG 25A		CH14gG 32A	CH14gG 40A		NH00gG 63A	
<b>Electrical specifications for fans</b>									
Rated power of standard fan	(1)	n° x kW	1 x 0,22	2 x 0,115	1 x 0,6	2 x 0,22	2 x 0,6	2 x 0,6	2 x 0,6
Rated current of standard fan	(1)	n° x A	1 x 0,97	2 x 0,51	1 x 2,62	2 x 0,97	2 x 2,62	2 x 2,62	2 x 2,62
Rated power of EC fan	(2)	n° x kW	1 x 0,12	2 x 0,11	1 x 0,26	2 x 0,13	2 x 0,25	2 x 0,28	2 x 0,58
Rated current of EC fan	(2)	n° x A	1 x 0,55	2 x 0,48	1 x 1,19	2 x 0,6	2 x 1,11	2 x 1,3	2 x 2,53

## EPSILON SKY Hi HP LE R7 [R32]

			6	12	18	24	30	36	45
<b>General electrical specifications</b>									
Max. absorbed power (FLI)	(1)	kW	4	10.7	11.1	14.4	15.2	25.2	25.2
Max. absorbed current	(1)	A	17	19	20.6	25.9	29.2	45.2	45.2
Nominal current (Inom)	(2)	A	11	5.7	9.7	11.9	16.1	19	25.7
cosφ standard unit	(2)		0.92	0.92	0.92	0.92	0.92	0.92	0.92
Maximum inrush current (MIC)	(3)	A	-	-	-	-	-	-	-
Power supply		V/ph/Hz	230/1~/50	400/3~+N/50	400/3~+N/50	400/3~+N/50	400/3~+N/50	400/3~+N/50	400/3~+N/50
Power supply for auxiliary circuits		V/ph/Hz	230- 24/1~/50	230- 24/1~/50	230- 24/1~/50	230- 24/1~/50	230- 24/1~/50	230- 24/1~/50	230- 24/1~/50
Suggested line section	(5)	mm <sup>2</sup>	3G4 FG16OR16	5G4 FG16OR16	5G6 FG16OR16	5G6 FG16OR16	5G6 FG16OR16	5G16 FG16OR16	5G16 FG16OR16
Suggested line protection	(6)		CH10gG 25A		CH14gG 32A	CH14gG 40A		NH00gG 63A	
<b>Electrical specifications for fans</b>									
Rated power of standard fan	(1)	n° x kW	1 x 0,22	2 x 0,115	1 x 0,6	2 x 0,22	2 x 0,6	2 x 0,6	2 x 0,6
Rated current of standard fan	(1)	n° x A	1 x 0,97	2 x 0,51	1 x 2,62	2 x 0,97	2 x 2,62	2 x 2,62	2 x 2,62
Rated power of EC fan	(2)	n° x kW	1 x 0,12	2 x 0,11	1 x 0,26	2 x 0,13	2 x 0,25	2 x 0,28	2 x 0,58
Rated current of EC fan	(2)	n° x A	1 x 0,55	2 x 0,48	1 x 1,19	2 x 0,6	2 x 1,11	2 x 1,3	2 x 2,53

(1) Data regarding the unit without accessories working in maximum power absorption conditions

(2) Datum related to the unit without accessories working in standard conditions (A35°C; W12-7°C)

(3) Maximum effective RMS value of the current when the last compressor starts (FLA of the entire unit - FLA of the largest compressor + LRA of the largest compressor)

(4) Maximum effective RMS value of the current when the last compressor starts (FLA of the entire unit - FLA of the largest compressor + 0.6 x LRA of the largest compressor)

(5) These values are determined for cables with operating temperature of 40°C, EPR insulation and a line with a maximum length of 50m. The line section must be determined by a qualified technician based on the protection devices, the length of the line, the type of cable used and the type of installation.

(6) The correct line protection part must be determined by a qualified technician based on the length of the line, the type of cable used and the type of installation.

# HYDRAULIC MODULES

## EPSILON SKY Hi R7 [R32]

			6	12	18	24	30	36	45	
Volume of the expansion vessel		I	2			5				
Volume of the buffer tank CH		I	70			130				
<b>Standard pumps</b>										
Pump model 1P, 2P			P1			P2 (P5)*		P3 (P6)*	P4 (P7)*	
Available head 1P	(1)	kPa	83	70	58	109 (180)*	89 (143)*	110 (180)*	174 (128)*	
<b>Oversize pumps</b>										
Pump model 1PM, 2PM			-			P8 (P6)*		P9 (P10)*	P9 (P11)*	
Available head 1PM	(1)	kPa	-			224 (283)*	190 (230)*	266 (258)*	262 (285)*	

(1) External air temperature 35°C, user-side heat exchanger water inlet/outlet temperature 12/7°C. Values in accordance with EN 14511.

(\*) Values refer to inverter pump.

## EPSILON SKY Hi HP R7 [R32]

			6	12	18	24	30	36	45	
Volume of the expansion vessel		I	2			5				
Volume of the buffer tank HP		I	70			130				
<b>Standard pumps</b>										
Pump model 1P, 2P			P1			P2 (P5)*		P3 (P6)*	P4 (P7)*	
Available head 1P	(1)	kPa	83	70	59	109 (181)*	89 (143)*	109 (178)*	173 (127)*	
<b>Oversize pumps</b>										
Pump model 1PM, 2PM			-			P8 (P6)*		P9 (P10)*	P9 (P11)*	
Available head 1PM	(1)	kPa	-			224 (283)*	190 (230)*	266 (258)*	262 (285)*	

(1) External air temperature 35°C, user-side heat exchanger water inlet/outlet temperature 12/7°C. Values in accordance with EN 14511.

(\*) Values refer to inverter pump.

## EPSILON SKY HP R7 [R32]

			18	24	30	36	45
Volume of the expansion vessel		I	2	5			
Volume of the buffer tank HP		I	130				
<b>Standard pumps</b>							
Pump model 1P, 2P			P1	P2 (P5)*		P3 (P6)*	P4 (P7)*
Available head 1P	(1)	kPa	60	109 (182)*	101 (162)*	135 (219)*	181 (133)*
<b>Oversize pumps</b>							
Pump model 1PM, 2PM			-	P8 (P6)*		P9 (P10)*	P9 (P11)*
Available head 1PM	(1)	kPa	-	224 (285)*	207 (254)*	283 (313)*	272 (298)*

(1) External air temperature 35°C, user-side heat exchanger water inlet/outlet temperature 12/7°C. Values in accordance with EN 14511.

(\*) Values refer to inverter pump.

---

## PUMP DATA

Model	Rated power	Rated current	Min. flow rate	Max. flow rate
	kW	A	m <sup>3</sup> /h	m <sup>3</sup> /h
<b>P1</b>	0.2	1.5	0.4	10.0
<b>P2</b>	0.52	2.24	2.4	7.2
<b>P3</b>	0.62	3.07	2.4	7.2
<b>P4</b>	1.1	5.85	5.0	14.0
<b>P5</b>	0.37	2.8	1.4	10.2
<b>P6</b>	0.55	3.4	1.4	10.2
<b>P7</b>	0.75	6.06	2.4	17.0
<b>P8</b>	0.73	4.05	2.4	7.2
<b>P9</b>	1.39	7.81	5.0	14.0
<b>P10</b>	0.75	4.05	1.4	10.2
<b>P11</b>	1.1	6.06	2.4	17.0

## USER-SIDE EXCHANGER FLOW RATE FIELDS

The units are sized and optimized for the following nominal conditions: external air 35°C, inlet/outlet of the user-side heat exchanger 12/7°C.

The units can work at design conditions different from nominal conditions, provided that:

- the design condition falls within the operating limits specified below
- the unit is equipped with all the accessories necessary for operation (e.g. brine kit, fan speed adjuster)
- the flow rate at design conditions (that is, of the specific application) must always come within the allowed flow rate ranges specified below. If the design conditions require a water flow rate that does not come within the allowed operating range, you must contact our sales department that will identify the most suitable solution for the specific application.

### EPSILON SKY R7 Hi [R32]

	Qmin	Qmax
	m <sup>3</sup> /h	m <sup>3</sup> /h
<b>6</b>	0.6	1.79
<b>12</b>	0.89	2.68
<b>18</b>	1.56	4.67
<b>24</b>	1.92	5.75
<b>30</b>	3.15	9.44
<b>36</b>	3.15	9.44
<b>45</b>	5.16	15.48

### EPSILON SKY R7 HP [R32]

	Qmin	Qmax
	m <sup>3</sup> /h	m <sup>3</sup> /h
<b>6</b>	-	-
<b>12</b>	-	-
<b>18</b>	1.56	4.67
<b>24</b>	1.92	5.75
<b>30</b>	3.15	9.44
<b>36</b>	3.15	9.44
<b>45</b>	5.16	15.48

### EPSILON SKY R7 Hi HP [R32]

	Qmin	Qmax
	m <sup>3</sup> /h	m <sup>3</sup> /h
<b>6</b>	0.6	1.79
<b>12</b>	0.89	2.68
<b>18</b>	1.56	4.67
<b>24</b>	1.92	5.75
<b>30</b>	3.15	9.44
<b>36</b>	3.15	9.44
<b>45</b>	5.16	15.48

---

# OPERATING LIMITS

## EPSILON SKY HI R7

### COOLING

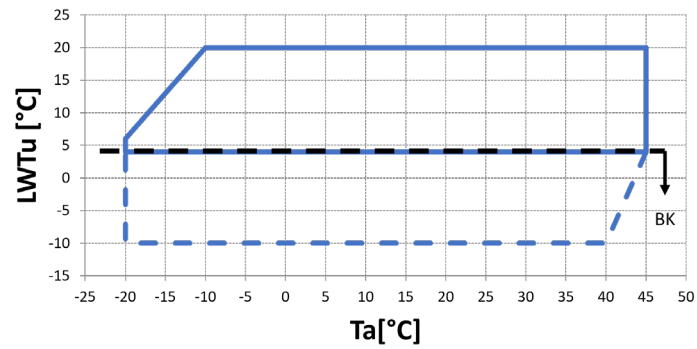

**Ta:** external air temperature

**LWTu:** water outlet temperature from the user-side heat exchanger

**BK:** For LWTu lower or equal to +4°C, it is mandatory to fit the "Brine Kit" accessory

For LWTu below +4°C, it is compulsory to use suitable percentages of antifreeze additives (glycols) to prevent ice formation in the exchanger.

The inlet and outlet temperatures of the user-side exchanger must be given on ordering to allow correct setting of the alarm parameters and verification of the sizing of the expansion valve.

The cooling set point can then be changed by the customer in an interval that, compared to the set point given on ordering, ranges from -1K up to the maximum temperature allowed by the above-stated operating limits.

The unit will be optimized to work at the set point temperatures given on ordering. For different set points, the cooling capacity provided and the level of efficiency of the machine could decrease and move away from these conditions.

# EPSILON SKY HI HP R7

## COOLING

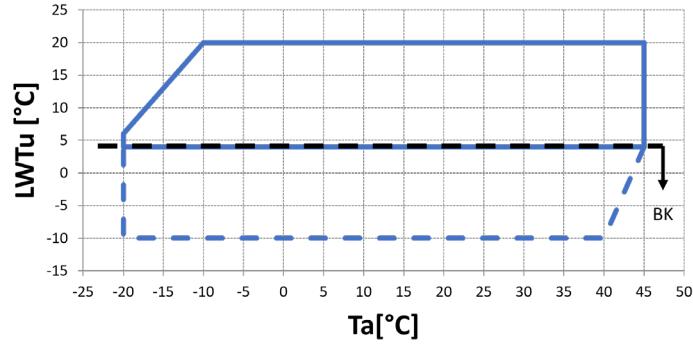

## HEATING

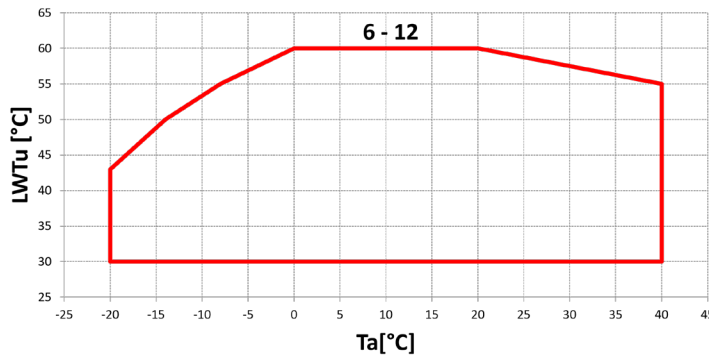

**Ta:** external air temperature

**LWTu:** water outlet temperature from the user-side heat exchanger

**BK:** For LWTu lower or equal to +4°C, it is mandatory to fit the "Brine Kit" accessory

For LWTu below +4°C, it is compulsory to use suitable percentages of antifreeze additives (glycols) to prevent ice formation in the exchanger.

The inlet and outlet temperatures of the user-side exchanger must be given on ordering to allow correct setting of the alarm parameters and verification of the sizing of the expansion valve.

The cooling set point can then be changed by the customer in an interval that, compared to the set point given on ordering, ranges from -1K up to the maximum temperature allowed by the above-stated operating limits.

The unit will be optimized to work at the set point temperatures given on ordering. For different set points, the cooling capacity provided and the level of efficiency of the machine could decrease and move away from these conditions.



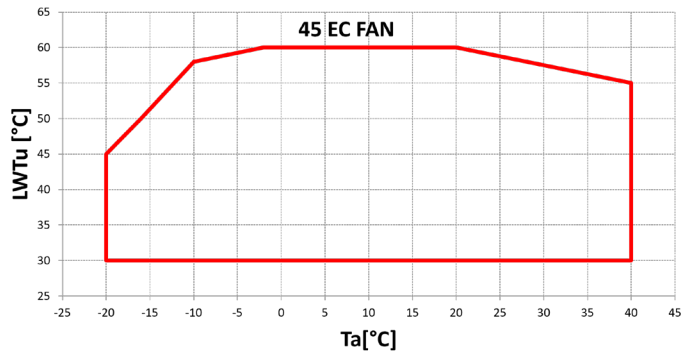
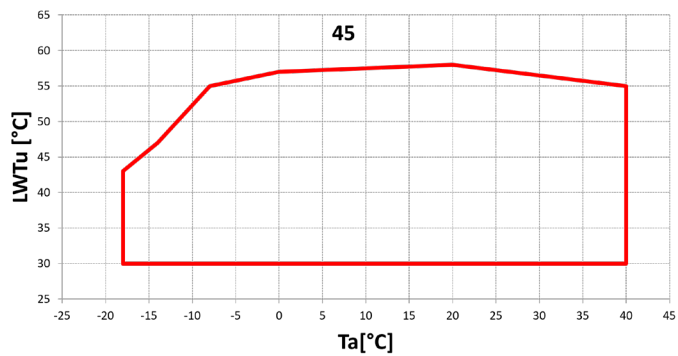
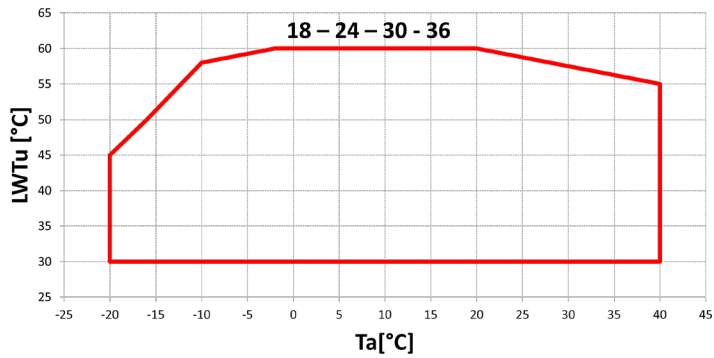

- Ta:** external air temperature
- LWTu:** water outlet temperature from the user-side heat exchanger
- BK:** For LWTu lower or equal to +4°C, it is mandatory to fit the "Brine Kit" accessory

For LWTu below +4°C, it is compulsory to use suitable percentages of antifreeze additives (glycols) to prevent ice formation in the exchanger.

The inlet and outlet temperatures of the user-side exchanger must be given on ordering to allow correct setting of the alarm parameters and verification of the sizing of the expansion valve.

The cooling set point can then be changed by the customer in an interval that, compared to the set point given on ordering, ranges from -1K up to the maximum temperature allowed by the above-stated operating limits.

The unit will be optimized to work at the set point temperatures given on ordering. For different set points, the cooling capacity provided and the level of efficiency of the machine could decrease and move away from these conditions.

# EPSILON SKY HP R7

## COOLING

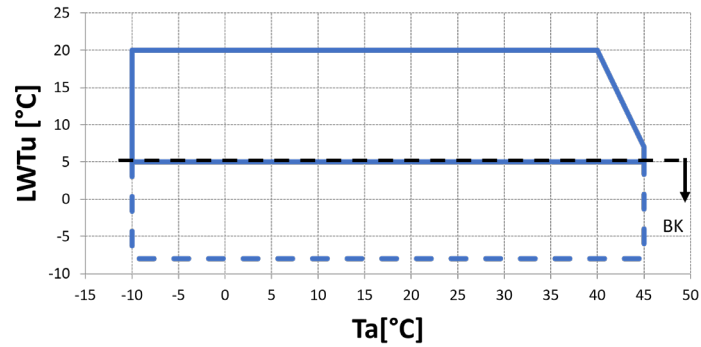

## HEATING

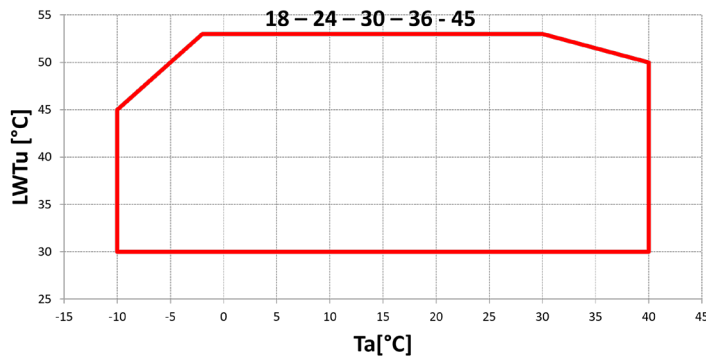

**Ta:** external air temperature

**LWTu:** water outlet temperature from the user-side heat exchanger

**BK:** For LWTu lower than or equal to +5 °C it is mandatory to provide the "Brine Kit" accessory

For LWTu below +5°C, it is compulsory to use suitable percentages of antifreeze additives (glycols) to prevent ice formation in the exchanger.

The inlet and outlet temperatures of the user-side exchanger must be given on ordering to allow correct setting of the alarm parameters and verification of the sizing of the expansion valve.

The cooling set point can then be changed by the customer in an interval that, compared to the set point given on ordering, ranges from -1K up to the maximum temperature allowed by the above-stated operating limits.

The unit will be optimized to work at the set point temperatures given on ordering. For different set points, the cooling capacity provided and the level of efficiency of the machine could decrease and move away from these conditions.

# EPSILON SKY HI LE R7-EPSILON SKY HI HP LE R7

## COOLING

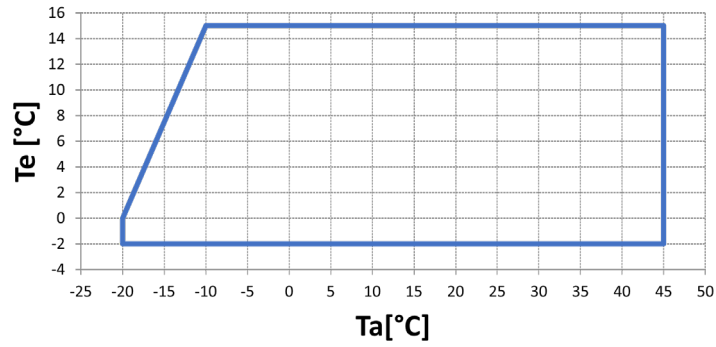

## HEATING

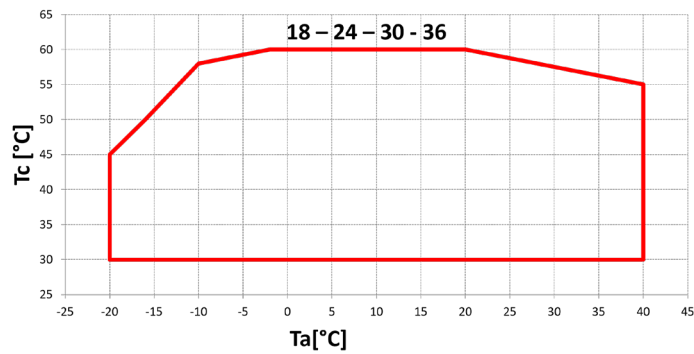
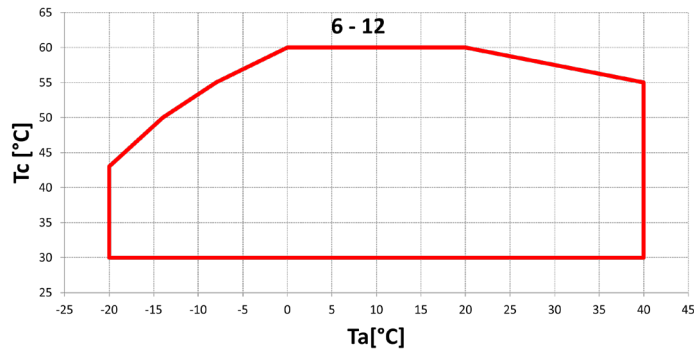

- $T_a$ :** external air temperature
- $T_e$ :** evaporating temperature
- $T_c$ :** condensing temperature

Operating limits refer to evaporating and condensing temperatures measured inside the unit.

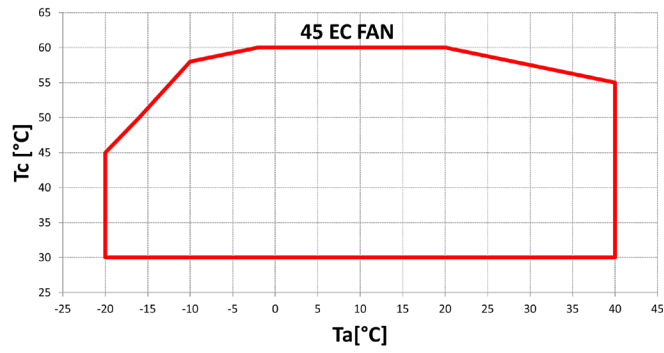
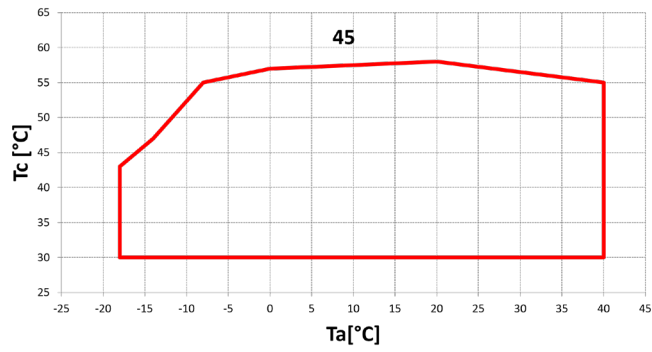

- Ta:** external air temperature
- Te:** evaporating temperature
- Te:** condensing temperature

Operating limits refer to evaporating and condensing temperatures measured inside the unit.

## NOISE LEVELS

### EPSILON SKY Hi-Hi HP-LE Hi-LE Hi HP R7 [R32]

#### Octave bands [dB]

#### Total

	63 Hz		125 Hz		250 Hz		500 Hz		1000 Hz		2000 Hz		4000 Hz		8000 Hz		[dB(A)]	
	Lw	Lp	Lw	Lp	Lw	Lp	Lw	Lp	Lw	Lp	Lw	Lp	Lw	Lp	Lw	Lp	Lw	Lp
<b>6</b>	78	47	78	47	73	42	71	40	65	33	60	28	56	25	50	19	<b>72</b>	<b>41</b>
<b>12</b>	78	47	78	47	73	42	71	40	65	33	60	28	56	25	50	19	<b>72</b>	<b>41</b>
<b>18</b>	75	44	76	45	74	43	70	38	67	36	65	33	60	29	56	25	<b>73</b>	<b>42</b>
<b>24</b>	78	47	78	47	75	43	71	39	69	37	69	38	62	30	58	27	<b>75</b>	<b>44</b>
<b>30</b>	84	53	83	52	77	46	74	42	70	38	70	38	65	33	60	29	<b>77</b>	<b>46</b>
<b>36</b>	84	52	84	52	80	48	76	45	75	44	72	41	66	34	62	31	<b>80</b>	<b>49</b>
<b>45</b>	92	60	91	59	81	50	80	48	77	46	74	43	70	39	66	35	<b>83</b>	<b>52</b>

Reference conditions: outside air temperature 35°C; input/output water temperature into/from user-side heat exchanger 12/7°C; unit operating at rated capacity, without any option.

**Lw:** sound power levels. Values obtained from measures taken according to standard ISO 3744. Lw\_tot is the only binding value.

**Lp:** sound pressure levels. Binding values starting from noise power levels referred to a distance of 10 m from the unit; source installed on a reflective surface and in ideal free field conditions with directivity factor Q=2. Non-binding values

The acoustic data are related to standard conditions in referable and reproducible operating conditions. All data with the exception of Lw\_tot are provided for illustrative purposes only and can not be used for forecasting purposes or for the verification of binding limits. With special reference to noise emissions, the Manufacturer takes liability for their conformity, limited to the declared Lw\_tot value. Any and all other Manufacturer's liability for the impact of such emissions in relation to the location of the machine and other conditions related to machine installation is excluded. The environment and the installation conditions, as well as the operating modes, can alter the sound emissions. Any assessment concerning these conditions falls within the area of competence of the plant designer and/or the fitter.

### EPSILON SKY HP R7 [R32]

#### Octave bands [dB]

#### Total

	63 Hz		125 Hz		250 Hz		500 Hz		1000 Hz		2000 Hz		4000 Hz		8000 Hz		[dB(A)]	
	Lw	Lp	Lw	Lp	Lw	Lp	Lw	Lp	Lw	Lp	Lw	Lp	Lw	Lp	Lw	Lp	Lw	Lp
<b>6</b>	-	-	-	-	-	-	-	-	-	-	-	-	-	-	-	-	-	-
<b>12</b>	-	-	-	-	-	-	-	-	-	-	-	-	-	-	-	-	-	-
<b>18</b>	75	44	76	45	74	43	70	38	67	36	65	33	60	29	56	25	<b>73</b>	<b>42</b>
<b>24</b>	78	47	78	47	75	43	71	39	69	37	69	38	62	30	58	27	<b>75</b>	<b>44</b>
<b>30</b>	84	53	83	52	77	46	74	42	70	38	70	38	65	33	60	29	<b>77</b>	<b>46</b>
<b>36</b>	84	52	84	52	80	48	76	45	75	44	72	41	66	34	62	31	<b>80</b>	<b>49</b>
<b>45</b>	92	60	92	60	82	51	82	51	81	49	75	44	71	39	66	35	<b>85</b>	<b>54</b>

Reference conditions: outside air temperature 35°C; input/output water temperature into/from user-side heat exchanger 12/7°C; unit operating at rated capacity, without any option.

**Lw:** sound power levels. Values obtained from measures taken according to standard ISO 3744. Lw\_tot is the only binding value.

**Lp:** sound pressure levels. Binding values starting from noise power levels referred to a distance of 10 m from the unit; source installed on a reflective surface and in ideal free field conditions with directivity factor Q=2. Non-binding values

The acoustic data are related to standard conditions in referable and reproducible operating conditions. All data with the exception of Lw\_tot are provided for illustrative purposes only and can not be used for forecasting purposes or for the verification of binding limits. With special reference to noise emissions, the Manufacturer takes liability for their conformity, limited to the declared Lw\_tot value. Any and all other Manufacturer's liability for the impact of such emissions in relation to the location of the machine and other conditions related to machine installation is excluded. The environment and the installation conditions, as well as the operating modes, can alter the sound emissions. Any assessment concerning these conditions falls within the area of competence of the plant designer and/or the fitter.

## INSTALLATION ADVICE

The units described in this document are, by nature, strongly affected by the characteristics of the system, the working conditions and the installation site.

Remember that the unit must be installed by a qualified and skilled technician, and in compliance with the national legislation in force in the destination country.

The installation must be done in such a way that it will be possible to carry out all routine and non-routine maintenance operations.

Before starting any work, you must carefully read the "Installation, operation and maintenance manual" of the machine and do the necessary safety checks to prevent any malfunctioning or hazards.

We give some advice below that will allow you to increase the efficiency and reliability of the unit and therefore of the system into which it is inserted.

### Water characteristics

To preserve the life of the exchangers, the water is required to comply with some quality parameters and it is therefore necessary to make sure its values fall within the ranges indicated in the following table:

<b>Total hardness</b>	2,0 ÷ 6,0 °f
<b>Langelier index</b>	- 0,4 ÷ 0,4
<b>pH</b>	7,5 ÷ 8,5
<b>Electrical conductivity</b>	10 ÷ 500 µS/cm
<b>Organic elements</b>	-
<b>Hydrogen carbonate (HCO<sub>3</sub><sup>-</sup>)</b>	70 ÷ 300 ppm
<b>Sulphates (SO<sub>4</sub><sup>2-</sup>)</b>	< 50 ppm
<b>Hydrogen carbonate / Sulphates (HCO<sub>3</sub><sup>-</sup>/SO<sub>4</sub><sup>2-</sup>)</b>	> 1
<b>Chlorides (Cl<sup>-</sup>)</b>	< 50 ppm
<b>Nitrates (NO<sub>3</sub><sup>-</sup>)</b>	< 50 ppm
<b>Hydrogen sulphide (H<sub>2</sub>S)</b>	< 0,05 ppm
<b>Ammonia (NH<sub>3</sub>)</b>	< 0,05 ppm
<b>Sulphites (SO<sub>3</sub>), free chlorine (Cl<sub>2</sub>)</b>	< 1 ppm
<b>Carbon dioxide (CO<sub>2</sub>)</b>	< 5 ppm
<b>Metal cations</b>	< 0,2 ppm
<b>Manganese ions (Mn<sup>++</sup>)</b>	< 0,2 ppm
<b>Iron ions ( Fe<sup>2+</sup> , Fe<sup>3+</sup>)</b>	< 0,2 ppm
<b>Iron + Manganese</b>	< 0,4 ppm
<b>Phosphates (PO<sub>4</sub><sup>3-</sup>)</b>	< 2 ppm
<b>Oxygen</b>	< 0,1 ppm

Installation of water filters on all the hydraulic circuits is obligatory.

The supply of the most suitable filters for the unit can be requested as accessory. In this case, the filters are supplied loose and must be installed by the customer following the instructions given in the installation, operation and maintenance manual.

### Glycol mixtures

With temperatures below 5°C, it is mandatory to work with water and anti-freeze mixtures, and also change the safety devices (anti-freeze, etc.), which must be carried out by qualified authorised personnel or by the manufacturer.

<b>Liquid outlet temperature or minimum ambient temperature</b>	°C	0	-5	-10	-15	-20	-25	-30	-35	-40
<b>Freezing point</b>	°C	-5	-10	-15	-20	-25	-30	-35	-40	-45
<b>Ethylene glycol</b>	%	6	22	30	36	41	46	50	53	56
<b>Propylene glycol</b>	%	15	25	33	39	44	48	51	54	57

The quantity of antifreeze should be considered as % on weight

---

## Minimum water content in the system

For correct operation of the unit, it is necessary to ensure a buffering on the system such as to comply with the minimum operating time considering the greater between the minimum OFF time and the minimum ON time. In short, these contribute to limiting the number of times the compressors are switched on per hour and to preventing undesired deviations from the set point of the delivered water temperature.

Larger amounts of water are in any case always preferable, because they allow a smaller number of starts and switch-offs of the compressors, less wear of them and an increase in the efficiency of the system as a consequence of a reduction in the number of transients.

It should also be pointed out that, for air-water units working in heat pump mode, the minimum amount of water must consider the need of the unit to carry out defrosting. Having an adequate buffering volume will allow prevention of too high drifts of the delivered water temperature at the end of the defrost cycle.

Please check "water Volume Design" Tool for a correct estimation of minimum water content of the system in "heat pump" working mode.

The following experimental formula allows to calculate the minimum water volume of the plant. Formula refers to unit operation in cooling mode and is also valid for heating mode if defrosting cycles are not taken in account.

$$V_{min} = \frac{P_{tot} \cdot 1000}{N} \cdot \frac{180}{\Delta T \rho C_p} + P_{tot} \cdot 0.25$$

where

$V_{min}$  is the minimum water content of the system [l]

$P_{tot}$  is the total cooling capacity of the machine [kW]

N: number of capacity reduction steps

$\Delta T$ : differential allowed on the water temperature. Unless otherwise specified, this value is considered to be 2.5K

$\rho$ : density of the heat-carrying fluid. Unless otherwise specified, the density of water is considered

$c_p$ : specific heat of the heat-carrying fluid. Unless otherwise specified, the specific heat of water is considered

Considering the use of water and grouping together some terms, the formula can be re-written as follows:

$$V_{min} = \frac{P_{tot}}{N} \cdot 17,2 + P_{tot} \cdot 0,25$$

N is equal to the number of compressors installed in the unit.

For units with inverter compressor:

- N=3 for units featuring one inverter-piloted compressor only;

In case of installation in cold climates where the unit has to perform defrosting cycles, it is suggested to use higher water content than that calculated with previous formula; due to very high volumes needed to completely compensate the negative effect of defrost on produced water temperature, are usually accepted higher temperature deviations than typical values accepted for cooling-only unit.

Water content necessary to balance defrost cycle effect on produced water temperatures, depends on various factors:

- type of system
- compressors and circuits number
- maximum temporary acceptable temperature difference from set-point
- Quantity of defrost cycles necessary to proper functioning of the unit (depending on external and working conditions)
- compressors and circuits number

---

## Installation site

To determine the best installation site for the unit and its orientation, you should pay attention to the following points:

- compliance with the clearance spaces indicated in the official dimensional drawing of the unit must be guaranteed so as to ensure accessibility for routine and non-routine maintenance operations
- you should consider the origin of the hydraulic pipes and their diameters because these affect the radiuses of curvature and therefore the spaces needed for installing them
- you should consider the position of the cable inlet on the electrical control panel of the unit as regards the origin of the power supply
- if the installation includes several units side by side, you should consider the position and dimensions of the manifolds of the user-side exchangers and of any recovery exchangers
- if the installation includes several units side by side, you should consider that the minimum distance between units is 3 metres
- you should avoid all obstructions that can limit air circulation to the source-side exchanger or that can cause recirculation between air supply and intake
- you should consider the orientation of the unit to limit, as far as possible, exposure of the source-side exchanger to solar radiation
- if the installation area is particularly windy, the orientation and positioning of the unit must be such as to avoid air recirculation on the coils. If necessary, we advise making windbreak barriers in order to prevent malfunctioning.

Once the best position for the unit has been identified, you must check that the support slab has the following characteristics:

- its dimensions must be proportionate to those of the unit: if possible, longer and wider than the unit by at least 30 cm and 15/20cm higher than the surrounding surface
- it must be able to bear at least 4 times the operating weight of the unit
- it must allow level installation of the unit: although the unit is installed on a horizontal base, make slopes in the support surface to convey rain water or defrost water to drains, wells or in any case to places where it cannot generate an accident hazard due to ice formation. All heat pump version units are equipped with discharge manifolds for the condensed water; these can be manifolded to facilitate condensate discharge.

The units are designed and built to reduce to a minimum the level of vibration transmitted to the ground, but it is in any case advisable to use rubber or spring anti-vibration mounts, which are available as accessory and should be requested when ordering.

The anti-vibration mounts must be fixed on before positioning the unit on the ground.

In the event of installation on roofs or intermediate floors, the pipes must be isolated from the walls and ceilings.

It is advisable to avoid installation in cramped places, to prevent reverberations, reflections, resonances and acoustic interactions with elements outside the unit.

It is essential that any work done to soundproof the unit does not affect its correct installation or correct operation and, in particular, does not reduce the air flow rate to the source-side exchanger.



---

## Installations that require the use of treated coils

If the unit has to be installed in an environment with a particularly aggressive atmosphere, coils with special treatments are available as options.

- coils with anti-corrosion treatment (accessory available only for HP units or with Cu/Al coil)

A description of the individual accessories is available in the "Description of accessories" section.

The type of coil treatment should be chosen with regard to the environment in which the unit is to be installed, through observation of other structures and machinery with exposed metal surfaces present in the destination environment.

The cross observation criterion is the most valid method of selection currently available without having to carry out preliminary tests or measurements with instruments. The identified reference environments are:

- coastal/marine
- industrial
- urban with a high housing density
- rural

Please note that in cases where different conditions co-exist, even for short periods, the choice must be suitable for preserving the exchanger in the harsher environmental conditions and not in conditions between the worst and best situation.

Particular attention must be given in cases where an environment that is not particularly aggressive becomes aggressive as a consequence of a concomitant cause, for example, the presence of a flue outlet or an extraction fan.

We strongly suggest choosing one of the treatment options if at least one of the points listed below is verified:

- there are obvious signs of corrosion of the exposed metal surfaces in the installation area
- the prevailing winds come from the sea towards the unit
- the environment is industrial with a significant concentration of pollutants
- the environment is urban with a high population density
- the environment is rural with the presence of organic discharges and effluents

In particular, for installations near the coast, the following instructions apply:

- **for installations between 1 and 20 km from the coast of reversible units or units with Cu/Al coils, is strongly recommended using the accessory "Coil treated with anti-corrosion paints"**
- **for distances within a kilometre of the coast, we strongly recommend using the accessory "Coil treated with anti-corrosion paints" for all units**

To protect the exchangers from corrosion and ensure optimal operation of the unit, we advise following the recommendations given in the user, installation and maintenance manual for cleaning the coils.

---

---

**Swegon Operations s.r.l.**

Via Valletta, 5 - 30010

Cantarana di Cona, (VE) Italy - T. +39 0426 921111 - F. +39 0426 302222

[www.blueboxcooling.com](http://www.blueboxcooling.com) - [info@bluebox.it](mailto:info@bluebox.it)



Swegon Operations s.r.l. a socio unico - P.IVA 02481290282

Company directed and coordinated by Investment Latour (Sweden)