

Sizing, installation, dimensions and weights GOLD RX

The charts and tables in this documentation are intended for use as a general survey.

Exact sizing can be carried out in the AHU Design air handling unit selection program.

Contents

Size 004.....	28
Size 005.....	32
Size 007.....	36
Size 008.....	40
Size 011.....	44
Size 012.....	47
Size 014/020	50
Size 025/030	54
Size 035/040	58
Size 050/060	61
Size 070/080	64
Size 100.....	67
Size 120.....	69
Electrical data, size 014-040	71
Electrical data, size 050-120	72

Sizing, installation, dimensions and weights

GOLD RX, rotary heat exchanger, size 004

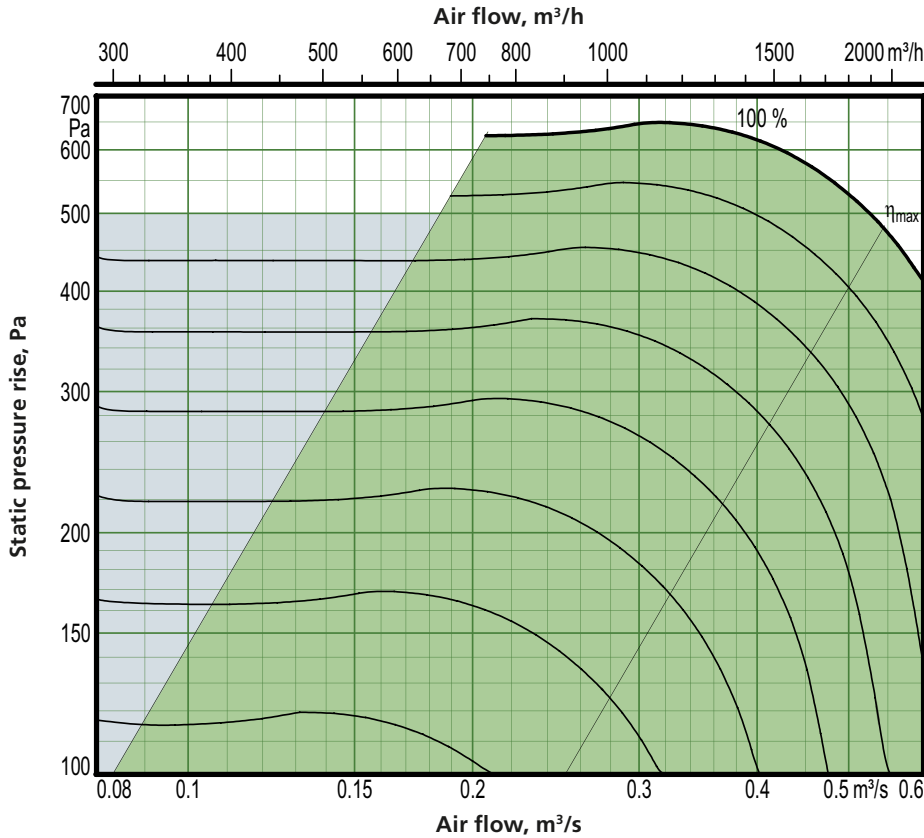

Motor shaft power: 1.15 kW (0.41 kW)

- Recommended working range for sizing.
- If pressure regulation is used, the air flow can be regulated to zero.
- However this presupposes a certain static pressure drop in the ducting (approx. 50 Pa).

Min. and max. airflows

The flows specified refer to those that can be preset in the hand-held terminal. The practical flow limits are determined by the external pressure drop.

Size	Min. airflow (on airflow regulation)		Max. airflow	
	m³/h	m³/s	m³/h	m³/s
004	288	0.08	1620	0.45

Exact sizing can be carried out in the AHU Design air handling unit selection program

Sizing, installation, dimensions and weights

GOLD RX, rotary heat exchanger, size 004, common casing

Delivery and Transport within the Site

The GOLD RX 004 is produced in one single variant. All of its components are arranged at their given physical location inside the air handling unit. The air handling unit is supplied on a wooden pallet.

Prefitted base beams are obtainable as optional equipment; a separately supplied stand is available as an accessory.

Duct connection options

A: Specify right-hand or left-hand version when ordering! If the air handling unit is supplied with all the end connection panels, the version can be changed at the building site by selecting the appropriate version in the hand-held micro terminal.

B: The air handling unit can be installed up ended (does not apply to units installed outdoors).

C: Specify upper fan outlet for upward air discharge when placing orders (Does not apply to units installed outdoors).
N.B.! Duct connection size: \varnothing 400 mm.

D: Specify whether the unit shall have an air intake from above for outdoor air or extract air when placing orders (Does not apply to units installed outdoors).

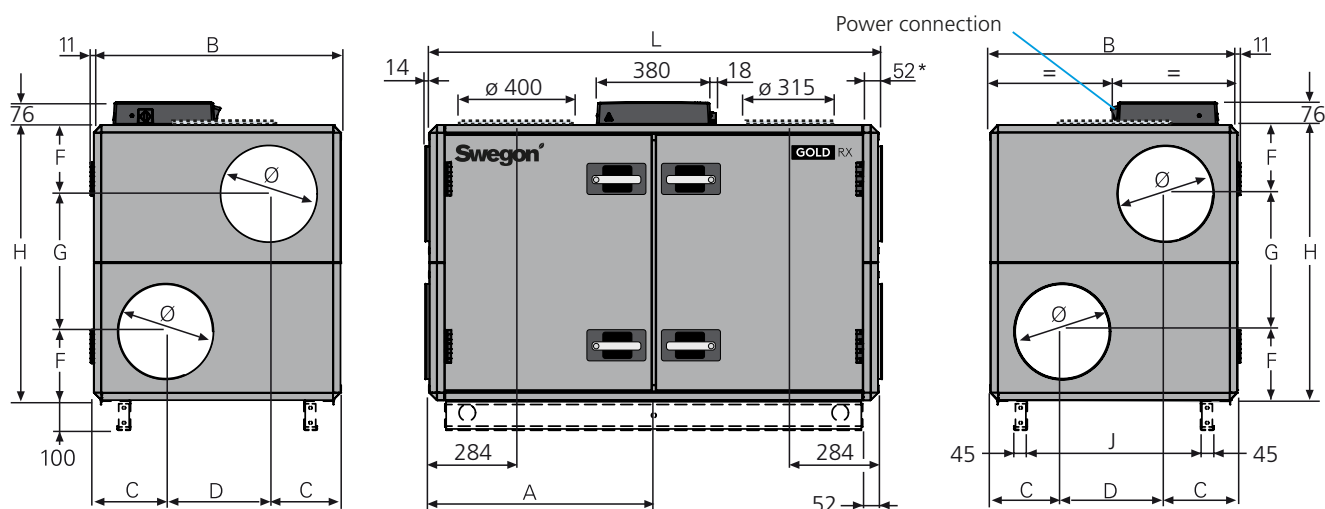
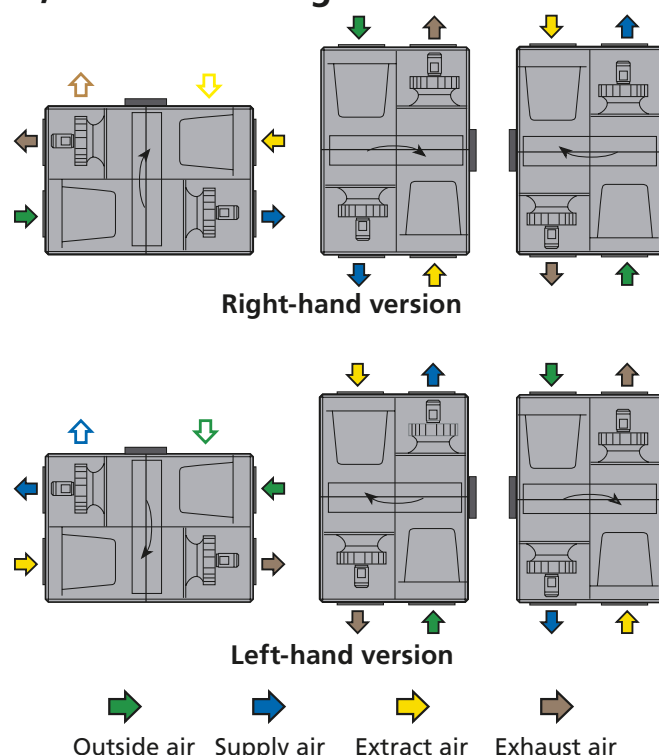

The base beams are optional.

* If duct accessories are inside an insulated casing, the air handling unit is supplied without end connection panel.
The AHU can also be supplied with full face end connection panel (accessory).

Size	A	B	C	D	F	G	H	J	L	Ø	Weight, kg
004	743	825	240	345	230	460	920	579	1499	315	234-278

Clear Space for Inspection

A clear space of 800 mm must be provided in front of the unit and at least 200 mm must be provided above the junction hood.

Power connection

1-phase, 3-wire, 230 V -10/+15%, 50 Hz, 10 A or
3-phase, 5-wire, 400 V -10/+15%, 50 Hz, 10 A

Rated data per fan

Motor shaft power: 1.15 kW (0.41 kW)*
motor control system, 1 x 230 V, 50 Hz

*The motor control system limits the power of the take-off to the value specified.

Sizing, installation, dimensions and weights

GOLD RX, rotary heat exchanger, size 004, split version

Delivery and transport within the site

The GOLD RX 004 can be supplied as one single unit, or in a number of different combinations of unit sections from the factory, see the section: Description of the Air Handling Unit/ Delivery Configuration RX/PX/CX, sizes 004-080.

Prefitted base beams as standard.

The unit sections are jointed together/split by means of bolts.

The electrical and control cables between the unit sections have quick-fit connectors.

Duct connection options

A: Specify right-hand or left-hand version when ordering. If the air handling unit is supplied with all the end connection panels, the version can be changed at the building site using the hand-held terminal.

B: The arrangement of the functional sections can be vertically reversed. To be specified when placing an order, see the illustration to the right.

C: Specify upper fan outlet for upward air discharge when placing orders (Does not apply to units installed outdoors).

N.B.! Duct connection size: \varnothing 400 mm.

D: Specify whether the unit shall have an air intake from above for outdoor air or extract air when placing orders (Does not apply to units installed outdoors).

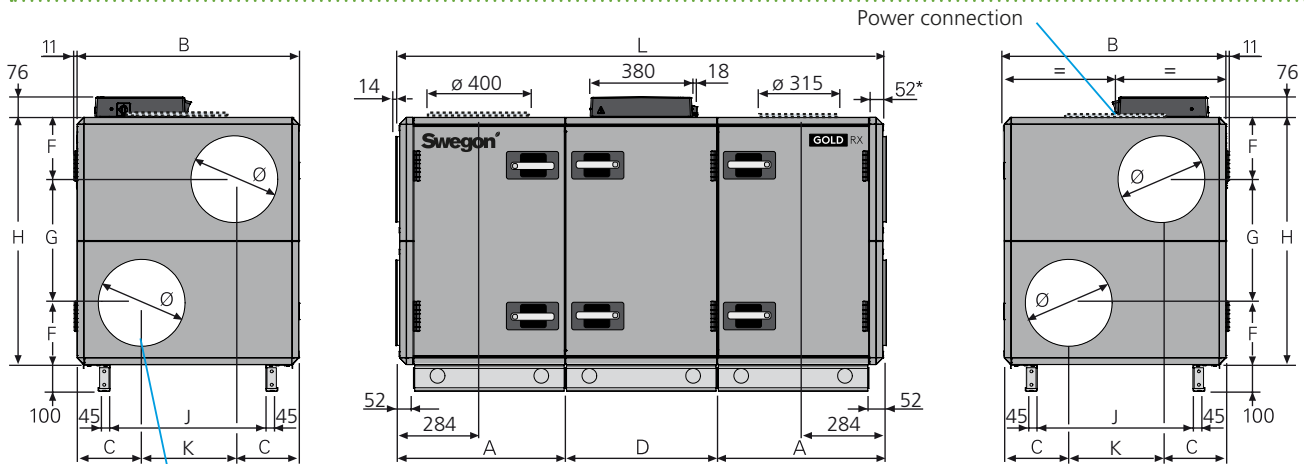
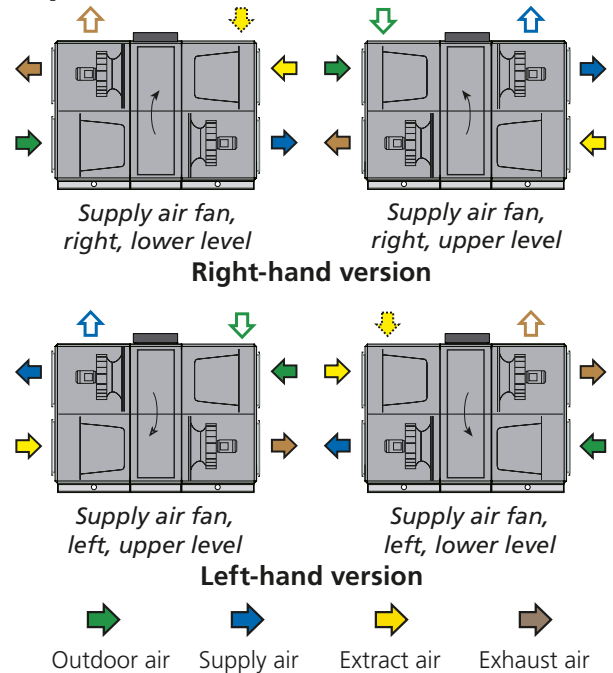

The illustration shows the connections for supply air fan, right-hand/lower level and left-hand/upper level. For supply air fan, right-hand/upper level and left-hand/lower level, the connections are mirror-inverted.

* The air handling unit is supplied without end connection panel if a duct accessory housed in an insulated casing will be connected.

The AHU can also be supplied with full face end connection panel (accessory).

Size	A	B	C	D	F	G	H	J	K	L	Ø	Weight, kg
004	617	825	240	565	230	460	920	579	345	1799	315	278-335

Division into sections for transport

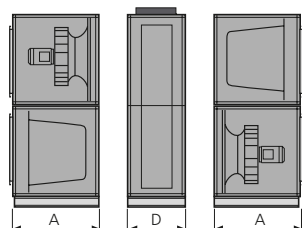

The unit can be divided into three sections at the building site.

Dimensions: See A and D in the table above.

Weight: A = 88-112 kg, D = 102-111 kg.

Power connection

1-phase, 3-wire, 230 V -10/+15%, 50 Hz, 10 A or 3-phase, 5-wire, 400 V -10/+15%, 50 Hz, 10 A

Rated data per fan

Motor shaft power 1.15 kW (0.41 kW)*,

Motor control system: 1 x 230 V, 50 Hz

*The motor control system limits the output power to the value specified.

Clear space for inspection

A clear space of 800 mm should be provided in front of the unit and at least 200 mm should be provided above the junction hood.

Sizing, installation, dimensions and weights

GOLD RX Top, rotary heat exchanger, size 004

Delivery and transport within the site

The GOLD RX Top 004 unit is produced in one variant in which all the components are arranged at their given physical location inside the unit.

The unit can also be delivered as L-concept with top fed duct connections in combination with side fed duct connections, see the section Description Air handling unit.

The air handling unit is supplied on a wooden pallet.

Prefitted base beams are obtainable as optional equipment.

Installation/duct connection options

A: All the duct connections are arranged from the top of the air handling unit (the unit must not be installed outdoors).

B: Specify right-hand or left-hand version when ordering. The version can be changed at the building site using the hand-held terminal. **Note:** Supply air filters and extract air filters have different dimensions and may need to be replaced for different filter classes.

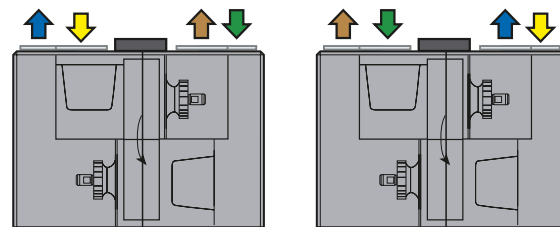

Left-hand version

Right-hand version

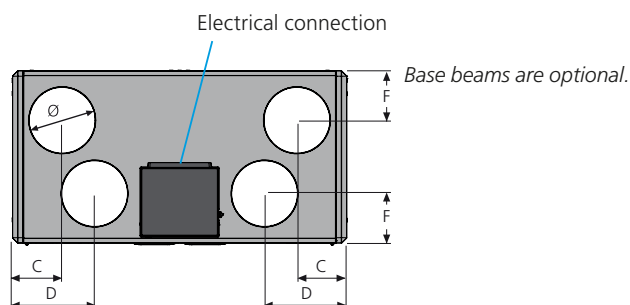
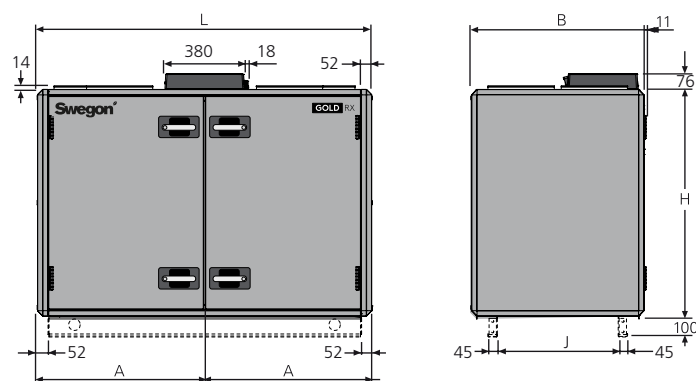

Size	A	B	C	D	F	H	J	L	Ø	Weight, kg
004	800	825	238	393	237	1085	579	1600	315	295-302

Clear space for inspection

A clear space of 800 mm should be provided in front of the unit and at least 200 mm should be provided above the junction hood.

Electrical connection

1-phase, 3-wire, 230 V -10/+15%, 50 Hz, 10 A or
3-phase, 5-wire, 400 V -10/+15%, 50 Hz, 10 A

Rated data per fan

Motor shaft power: 1.15 kW (0.41 kW)*,
motor control system: 1 x 230 V, 50 Hz

*The motor control system limits the output power to the value specified.

Sizing, installation, dimensions and weights

GOLD RX, rotary heat exchanger, size 005

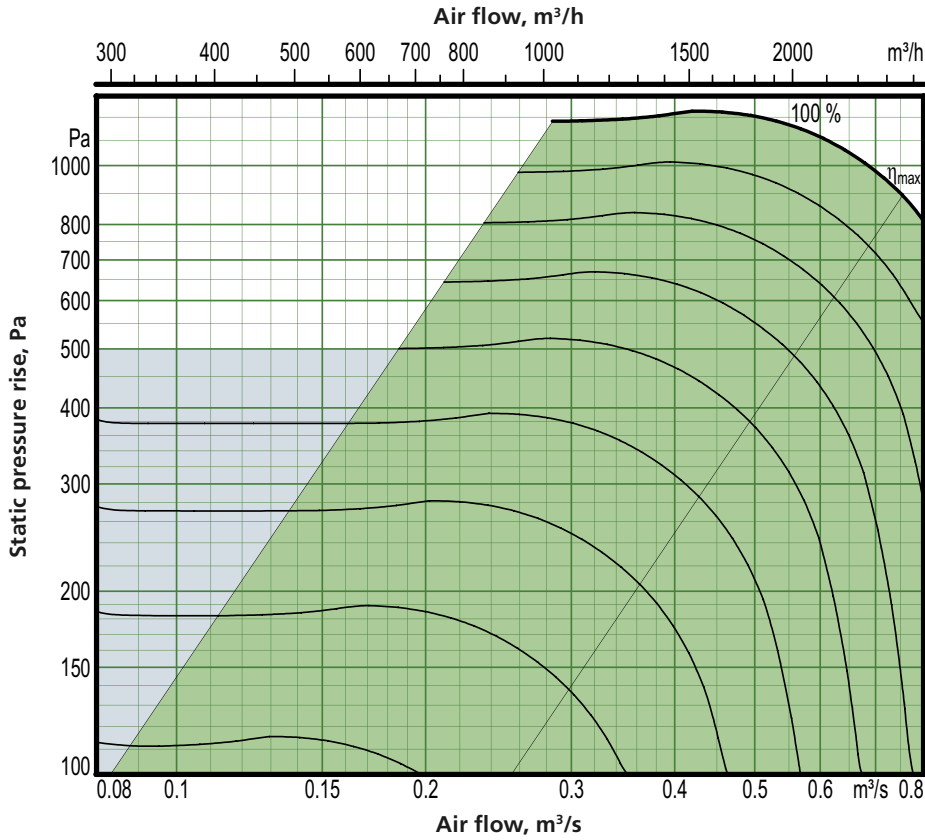

Motor shaft power: 1.15 kW (capacity variant 2)

- Recommended working range for sizing.
- If pressure regulation is used, the air flow can be regulated to zero.
- However this presupposes a certain static pressure drop in the ducting (approx. 50 Pa).

Min. and max. air flows

The flows specified refer to those that can be preset in the hand-held terminal. The practical flow limits are determined by the external pressure drop.

Size	Min. airflow (on airflow regulation)		Max. airflow	
	m ³ /h	m ³ /s	m ³ /h	m ³ /s
005	288	0.08	2340	0.65

Exact sizing can be carried out in the AHU Design air handling unit selection program

Sizing, installation, dimensions and weights

GOLD RX, rotary heat exchanger, size 005, common casing

Delivery and Transport within the Site

The GOLD RX 005 is produced in one single variant, in which all the components are arranged at their given physical locations inside the air handling unit. The air handling unit is supplied on a wooden pallet.

Prefitted base beams are obtainable as optional equipment; a separately supplied stand is available as an accessory.

Duct connection options

A: Specify right-hand or left-hand version when ordering! If the air handling unit is supplied with all the end connection panels, the version can be changed at the building site by selecting the appropriate version in the hand-held micro terminal.

B: The air handling unit can be installed up ended (does not apply to units installed outdoors).

C: Specify upper fan outlet for upward air discharge when placing orders (Does not apply to units installed outdoors).
N.B.! Duct connection size: \varnothing 400 mm.

D: Specify whether the unit shall have an air intake from above for outdoor air or extract air when placing orders (Does not apply to units installed outdoors).

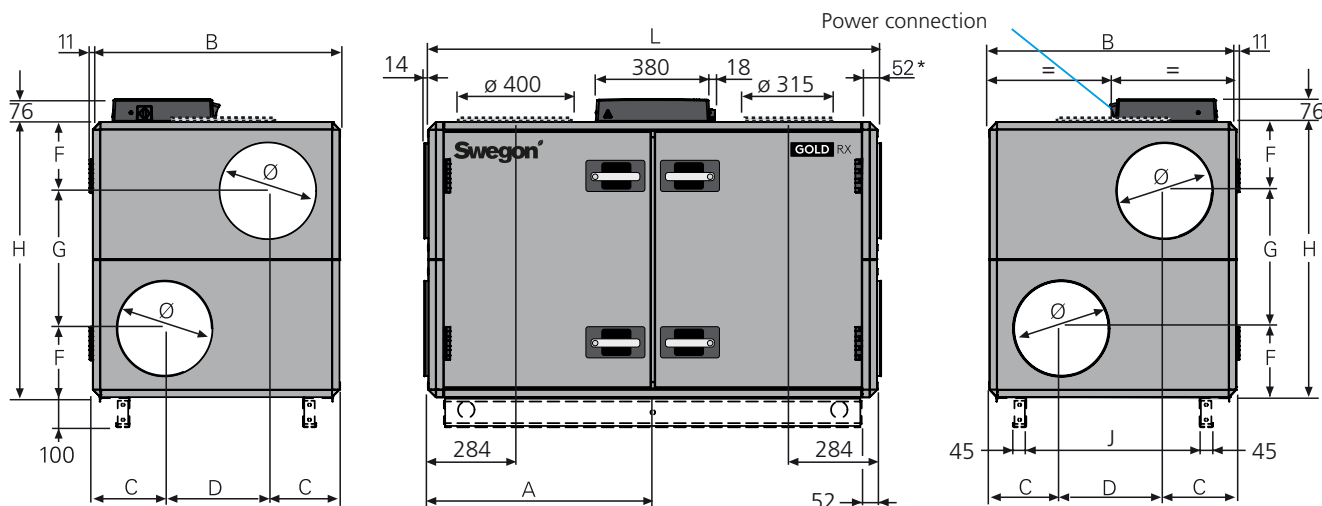
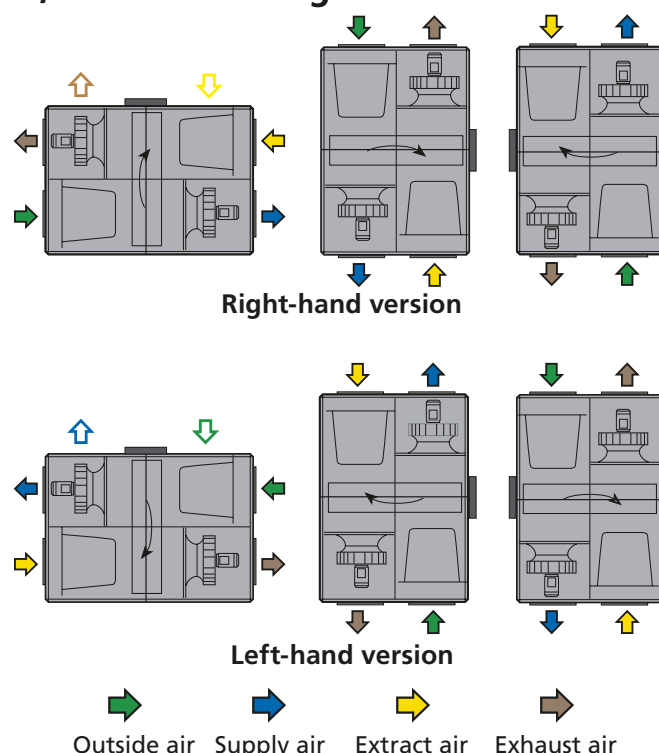

The base beams are optional.

* If duct accessories are inside an insulated casing, the air handling unit is supplied without end connection panel. The AHU can also be supplied with full face end connection panel (accessory).

Size	A	B	C	D	F	G	H	J	L	Ø	Weight, kg
005	743	825	240	345	230	460	920	579	1499	315	234-278

Clear Space for Inspection

A clear space of 800 mm must be provided in front of the unit and at least 200 mm must be provided above the junction hood.

Power connection

1-phase, 3-wire, 230 V -10/+15%, 50 Hz, 10 A (capacity variant 1) alt. 16 A (capacity variant 2) or 3-phase, 5-wire, 400 V -10/+15%, 50 Hz, 10 A

Rated data per fan

Motor shaft power: 1.15 kW (0.8 kW* or 1.15 kW), motor control system: 1 x 230 V, 50 Hz

*The motor control system limits the output power to the value specified.

Sizing, installation, dimensions and weights

GOLD RX, rotary heat exchanger, size 005, split version

Delivery and transport within the site

The GOLD RX 005 can be supplied as one single unit, or in a number of different combinations of unit sections from the factory, see the section: Description of the Air Handling Unit/ Delivery Configuration RX/PX/CX, sizes 004-080.

Prefitted base beams as standard.

The unit sections are jointed together/split by means of bolts.

The electrical and control cables between the unit sections have quick-fit connectors.

Duct connection options

A: Specify right-hand or left-hand version when ordering. If the air handling unit is supplied with all the end connection panels, the version can be changed at the building site using the hand-held terminal.

B: The arrangement of the functional sections can be vertically reversed. To be specified when placing an order, see the illustration to the right.

C: Specify upper fan outlet for upward air discharge when placing orders (Does not apply to units installed outdoors).

N.B.! Duct connection size: \varnothing 400 mm.

D: Specify whether the unit shall have an air intake from above for outdoor air or extract air when placing orders (Does not apply to units installed outdoors).

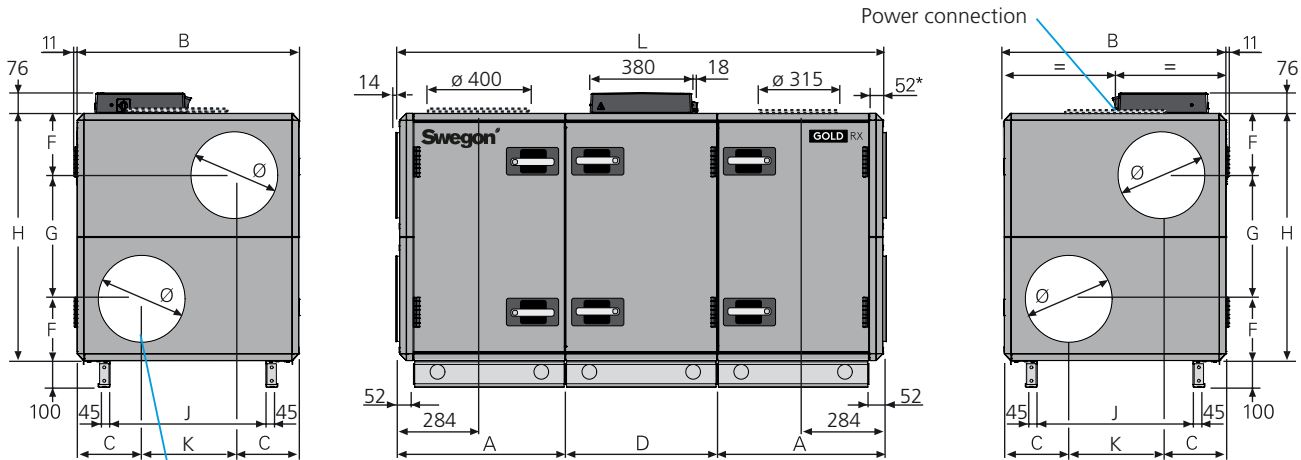
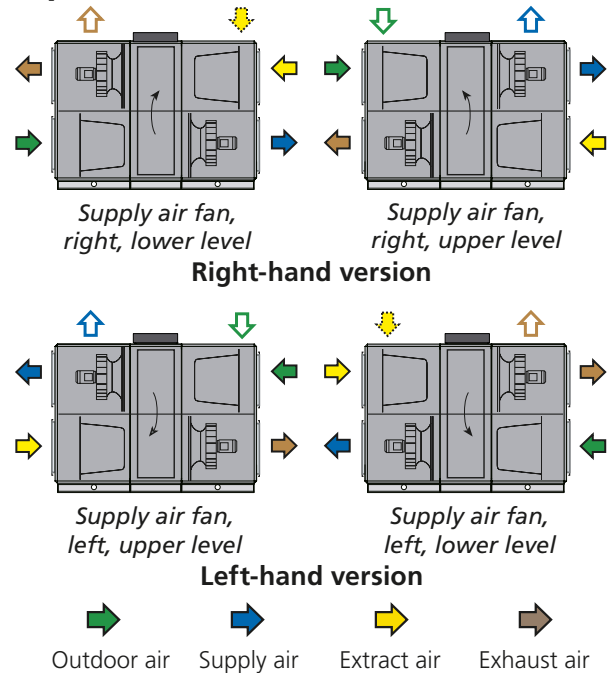

The illustration shows the connections for supply air fan, right-hand/lower level and left-hand/upper level.

For supply air fan, right-hand/upper level and left-hand/lower level, the connections are mirror-inverted.

* The air handling unit is supplied without end connection panel if a duct accessory housed in an insulated casing will be connected.

The AHU can also be supplied with full face end connection panel (accessory).

Size	A	B	C	D	F	G	H	J	K	L	Ø	Weight, kg
005	617	825	240	565	230	460	920	579	345	1799	315	278-335

Division into sections for transport

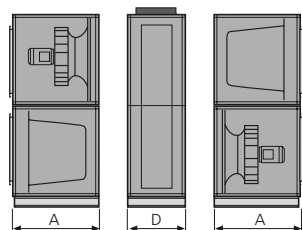

The unit can be divided into three sections at the building site.

Dimensions: See A and D in the table above.

Weight: A = 88-112 kg, D = 102-111 kg.

Power connection

1-phase, 3-wire, 230 V -10/+15%, 50 Hz, 10 A (capacity variant 1) or 16 A (capacity variant 2) or 3-phase, 5-wire, 400 V -10/+15%, 50 Hz, 10 A

Rated data per fan

Motor shaft power: 1.15 kW (0.8 kW* or 1.15 kW), motor control system: 1 x 230 V, 50 Hz

*The motor control system limits the output power to the value specified.

Clear space for inspection

A clear space of 800 mm should be provided in front of the unit and at least 200 mm should be provided above the junction hood.

Sizing, installation, dimensions and weights

GOLD RX Top, rotary heat exchanger, size 005

Delivery and transport within the site

The GOLD RX Top 005 unit is produced in one variant in which all the components are arranged at their given physical location inside the unit.

The unit can also be delivered as L-concept with top fed duct connections in combination with side fed duct connections, see the section Description Air handling unit.

The air handling unit is supplied on a wooden pallet.

Prefitted base beams are obtainable as optional equipment.

Installation/duct connection options

A: All the duct connections are arranged from the top of the air handling unit (the unit must not be installed outdoors).

B: Specify right-hand or left-hand version when ordering. The version can be changed at the building site using the hand-held terminal. **Note:** Supply air filters and extract air filters have different dimensions and may need to be replaced for different filter classes.

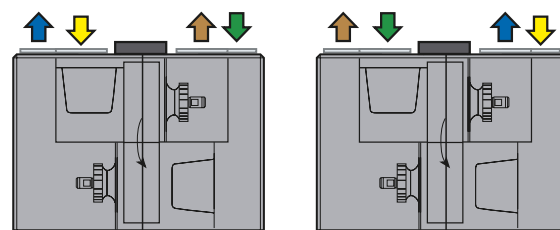

Left-hand version

Right-hand version

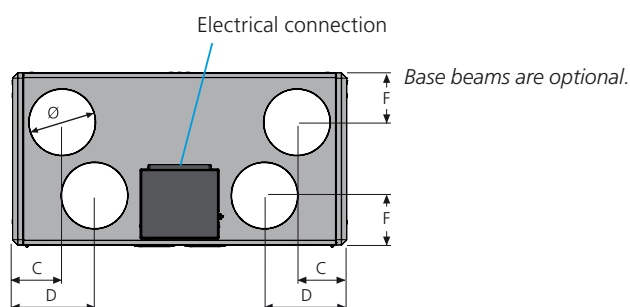
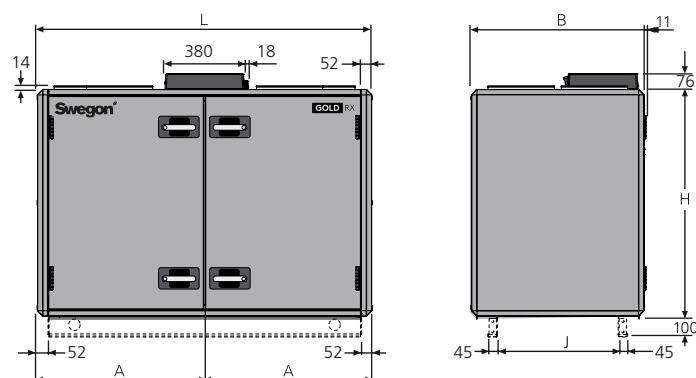
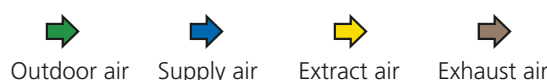

Size	A	B	C	D	F	H	J	L	Ø	Weight, kg
005	800	825	238	393	237	1085	579	1600	315	295-310

Clear space for inspection

A clear space of 800 mm should be provided in front of the unit and at least 200 mm should be provided above the junction hood.

Electrical connection

1-phase, 3-wire, 230 V -10/+15%, 50 Hz, 10 A (capacity variant 1) or 16 A (capacity variant 2) or 3-phase, 5-wire, 400 V -10/+15%, 50 Hz, 10 A

Rated data per fan

Motor shaft power: 1.15 kW (0.8 kW* or 1.15 kW), motor control system: 1 x 230 V, 50 Hz

*The motor control system limits the output power to the value specified.

Sizing, installation, dimensions and weights

GOLD RX, rotary heat exchanger, size 007

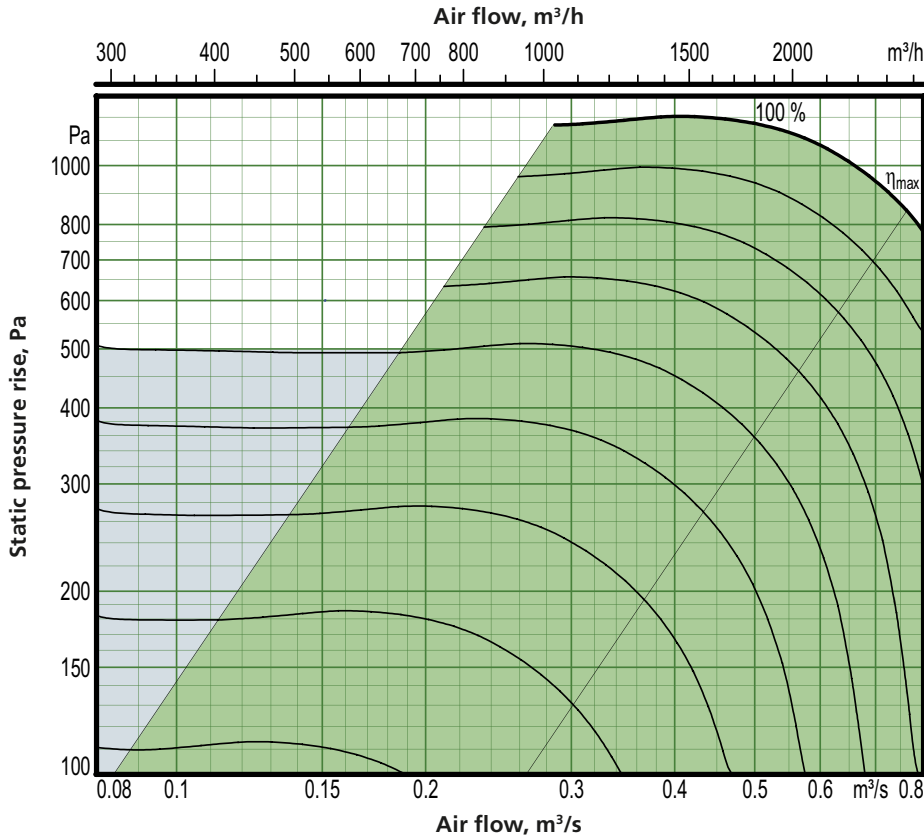

Motor shaft power: 1.15 kW (capacity variant 2)

- Recommended working range for sizing.
- If pressure regulation is used, the air flow can be regulated to zero.
- However this presupposes a certain static pressure drop in the ducting (approx. 50 Pa).

Min. and max. air flows

The flows specified refer to those that can be preset in the hand-held terminal. The practical flow limits are determined by the external pressure drop.

Size	Min. airflow (on airflow regulation)		Max. airflow	
	m ³ /h	m ³ /s	m ³ /h	m ³ /s
007	288	0.08	2700	0.75

Exact sizing can be carried out in the AHU Design air handling unit selection program

Sizing, installation, dimensions and weights

GOLD RX, rotary heat exchanger, size 007, common casing

Delivery and transport within the site

The GOLD RX 007 is produced in one single variant. All of its components are arranged at their given physical location inside the air handling unit. The air handling unit is supplied on a wooden pallet.

Prefitted base beams are obtainable as optional equipment; a separately supplied stand is available as an accessory.

Duct connection options

A: Specify right-hand or left-hand version when ordering. If the air handling unit is supplied with all the end connection panels, the version can be changed at the building site by selecting the appropriate version in the hand-held micro terminal.

B: The air handling unit can be installed up ended (does not apply to units installed outdoors).

C: Specify upper fan outlet for upward air discharge when placing orders (Does not apply to units installed outdoors).

N.B.! Duct connection size: \varnothing 500 mm.

D: Specify whether the unit shall have an air intake from above for outdoor air or extract air when placing orders (Does not apply to units installed outdoors).

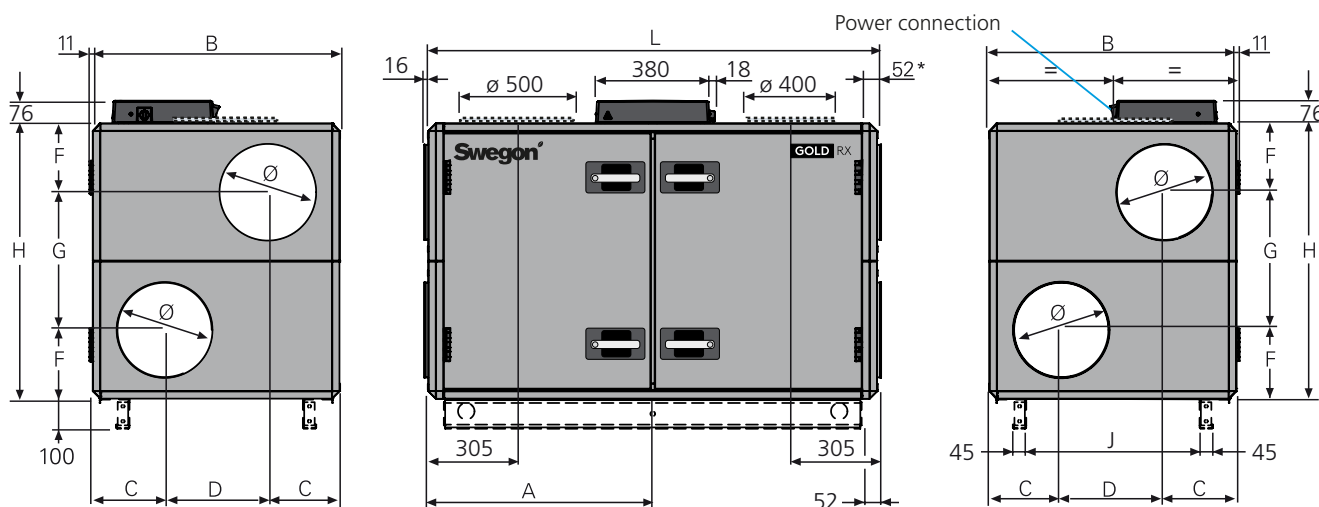
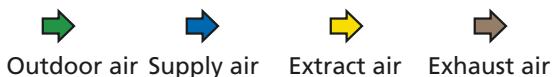
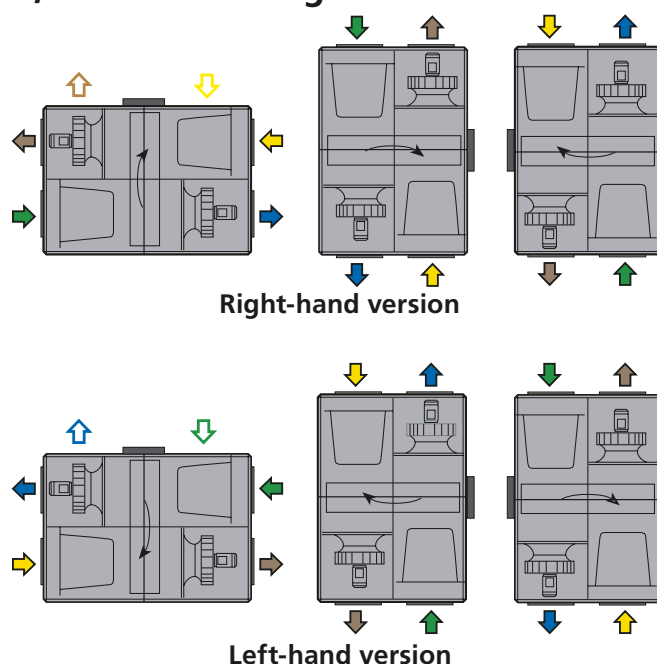

The base beams are optional.

* If duct accessories are inside an insulated casing, the air handling unit is supplied without end connection panel.

The AHU can also be supplied with full face end connection panel (accessory).

Size	A	B	C	D	F	G	H	J	L	Ø	Weight, kg
007	805	995	277,5	440	271	543	1085	749	1619	400	281-355

Clear space for inspection

A clear space of 900 mm should be provided in front of the unit and at least 200 mm should be provided above the junction hood.

Power connection

1-phase, 3-wire cable, 230 V -10/+15%, 50 Hz, 10 A (capacity variant 1) alt. 16 A (capacity variant 2) or 3-phase, 5-wire cable, 400 V -10/+15%, 50 Hz, 10 A

Rated data per fan

Motor shaft power: 1.15 kW (0.8 kW* or 1.15 kW), motor control system: 1 x 230 V, 50 Hz

*The motor control system limits the output power to the value specified.

Sizing, installation, dimensions and weights

GOLD RX, rotary heat exchanger, size 007, split version

Delivery and transport within the site

The GOLD RX 007 can be supplied as one single unit, or in a number of different combinations of unit sections from the factory, see the section: Description of the Air Handling Unit/Delivery Configuration RX/PX/CX, sizes 004-080.

Prefitted base beams as standard.

The unit sections are jointed together/split by means of bolts. The electrical and control cables between the unit sections have quick-fit connectors.

Duct connection options

A: Specify right-hand or left-hand version when ordering. If the air handling unit is supplied with all the end connection panels, the version can be changed at the building site using the hand-held terminal.

B: The arrangement of the functional sections can be vertically reversed. To be specified when placing an order, see the illustration to the right.

C: Specify upper fan outlet for upward air discharge when placing orders (Does not apply to units installed outdoors).

N.B.! Duct connection size: \varnothing 500 mm.

D: Specify whether the unit shall have an air intake from above for outdoor air or extract air when placing orders (Does not apply to units installed outdoors).

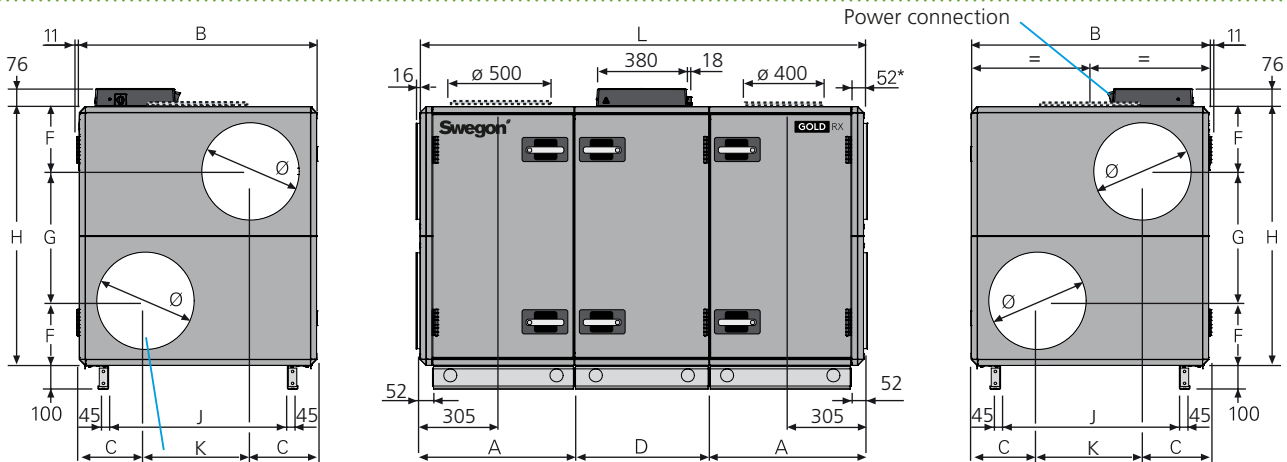
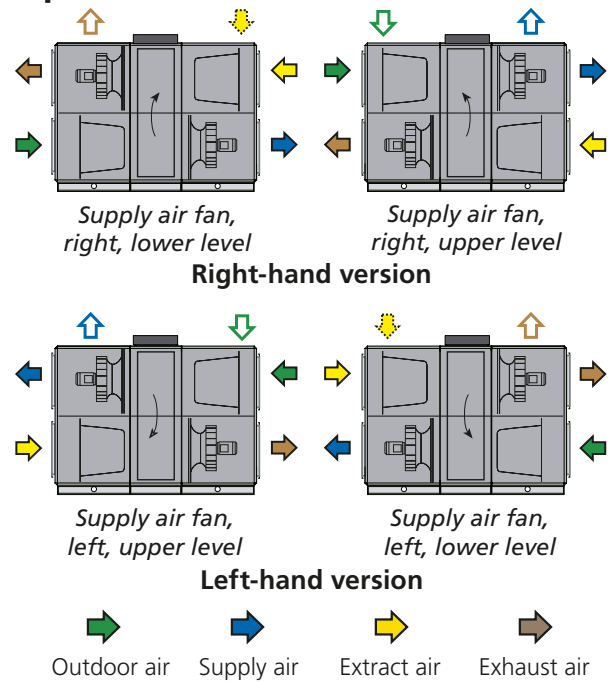

The illustration shows the connections for supply air fan, right-hand/lower level and left-hand/upper level.

For supply air fan, right-hand/upper level and left-hand/lower level, the connections are mirror-inverted.

* The air handling unit is supplied without end connection panel if a duct accessory housed in an insulated casing will be connected.

The AHU can also be supplied with full face end connection panel (accessory).

Size	A	B	C	D	F	G	H	J	K	L	\varnothing	Weight, kg
007	647.5	995	277.5	565	271	543	1085	749	440	1860	400	327-412

Division into sections for transport

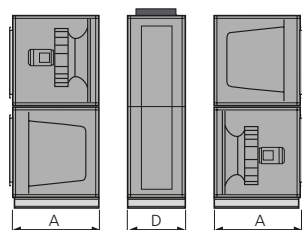

The unit can be divided into three sections at the building site.

Dimensions: See A and D in the table above.

Weight: A = 103-138 kg, D = 121-136 kg.

Power connection

1-phase, 3-wire, 230 V -10/+15%, 50 Hz, 10 A (capacity variant 1) or 16 A (capacity variant 2) or 3-phase, 5-wire, 400 V -10/+15%, 50 Hz, 10 A

Rated data per fan

Motor shaft power: 1.15 kW (0.8 kW* or 1.15 kW), motor control system: 1 x 230 V, 50 Hz

*The motor control system limits the output power to the value specified.

Clear space for inspection

A clear space of 900 mm should be provided in front of the unit and at least 200 mm should be provided above the junction hood.

Sizing, installation, dimensions and weights

GOLD RX, rotary heat exchanger, size 008

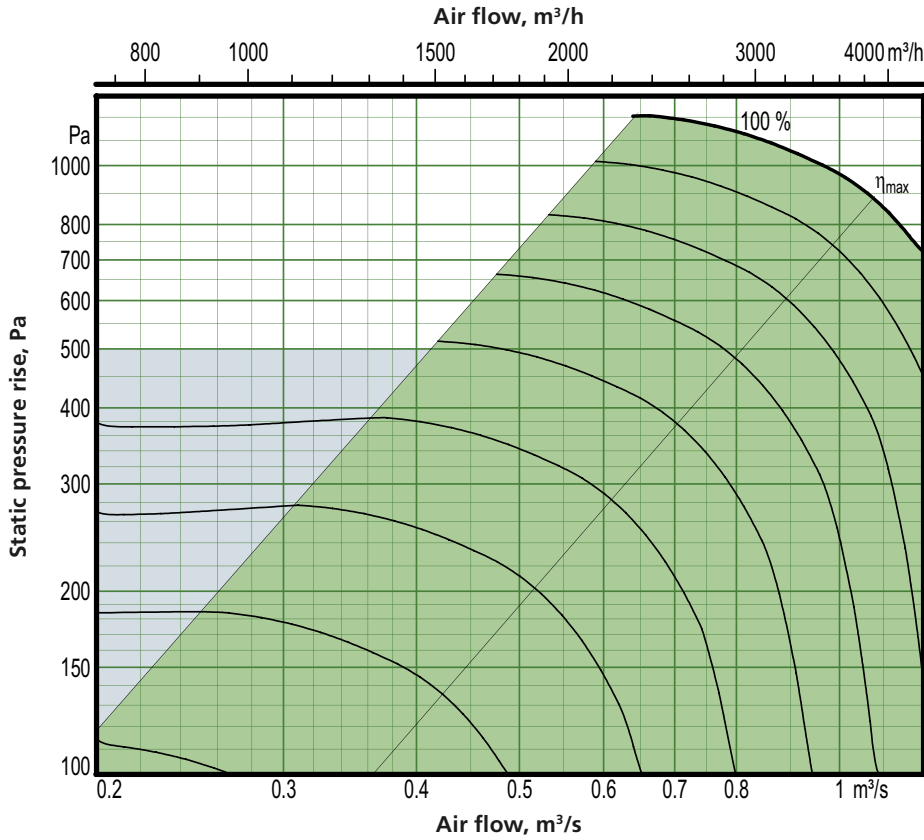

Motor shaft power: 1.6 kW (capacity variant 2)

- Recommended working range for sizing.
- If pressure regulation is used, the air flow can be regulated to zero.
- However this presupposes a certain static pressure drop in the ducting (approx. 50 Pa).

Min. and max. air flows

The flows specified refer to those that can be preset in the hand-held terminal. The practical flow limits are determined by the external pressure drop.

Size	Min. airflow (on airflow regulation)		Max. airflow	
	m³/h	m³/s	m³/h	m³/s
008	720	0.20	3600	1.00

Exact sizing can be carried out in the AHU Design air handling unit selection program

Sizing, installation, dimensions and weights

GOLD RX, rotary heat exchanger, size 008, common casing

Delivery and Transport within the Site

The GOLD RX 008 is produced in one single variant, in which all the components are arranged at their given physical locations inside the air handling unit. The air handling unit is supplied on a wooden pallet.

Prefitted base beams are obtainable as optional equipment; a separately supplied stand is available as an accessory.

Duct connection options

A: Specify right-hand or left-hand version when ordering! If the air handling unit is supplied with all the end connection panels, the version can be changed at the building site by selecting the appropriate version in the hand-held micro terminal.

B: The air handling unit can be installed up ended (does not apply to units installed outdoors).

C: Specify upper fan outlet for upward air discharge when placing orders (Does not apply to units installed outdoors).

N.B.! Duct connection size: \varnothing 500 mm.

D: Specify whether the unit shall have an air intake from above for outdoor air or extract air when placing orders (Does not apply to units installed outdoors).

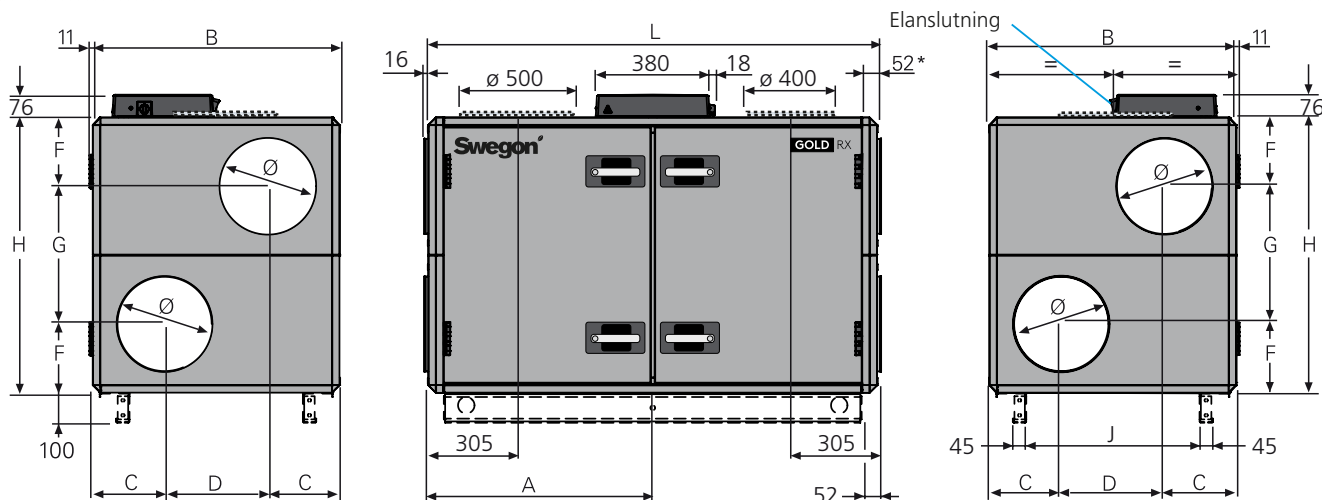
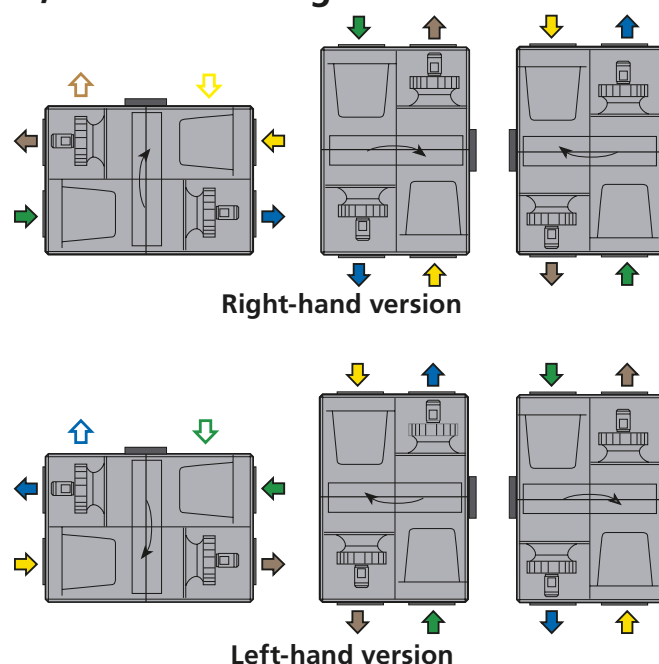

The base beams are optional.

* If duct accessories are inside an insulated casing, the air handling unit is supplied without end connection panel.

The AHU can also be supplied with full face end connection panel (accessory)..

Storlek	A	B	C	D	F	G	H	J	L	\varnothing	Vikt, kg
008	805	995	277,5	440	271	543	1085	749	1619	400	295-363

Clear Space for Inspection

A clear space of 900 mm must be provided in front of the unit and at least 200 mm must be provided above the junction hood.

Power connection

Capacity variant 1:

1-phase, 3-wire, 230 V -10/+15%, 50 Hz, 16 A or
3-phase, 5-wire, 400 V -10/+15%, 50 Hz, 10 A

Capacity variant 2:

3-phase, 5-wire, 400 V -10/+15%, 50 Hz, 10 A

Rated data per fan

Capacity variant 1:

Motor shaft power: 1.15 kW,
motor control system: 1 x 230 V, 50 Hz

Capacity variant 2:

Motor shaft power: 1.6 kW,
motor control system: 3 x 400 V, 50 Hz

Sizing, installation, dimensions and weights

GOLD RX, rotary heat exchanger, size 008, split version

Delivery and transport within the site

The GOLD RX 008 can be supplied as one single unit, or in a number of different combinations of unit sections from the factory, see the section: Description of the Air Handling Unit/ Delivery Configuration RX/PX/CX, sizes 004-080. Prefitted base beams as standard. The unit sections are jointed together/split by means of bolts. The electrical and control cables between the unit sections have quick-fit connectors.

Duct connection options

- A:** Specify right-hand or left-hand version when ordering. If the air handling unit is supplied with all the end connection panels, the version can be changed at the building site using the hand-held terminal.
- B:** The arrangement of the functional sections can be vertically reversed. To be specified when placing an order, see the illustration to the right.
- C:** Specify upper fan outlet for upward air discharge when placing orders (Does not apply to units installed outdoors). N.B.! Duct connection size: \varnothing 500 mm.
- D:** Specify whether the unit shall have an air intake from above for outdoor air or extract air when placing orders (Does not apply to units installed outdoors).

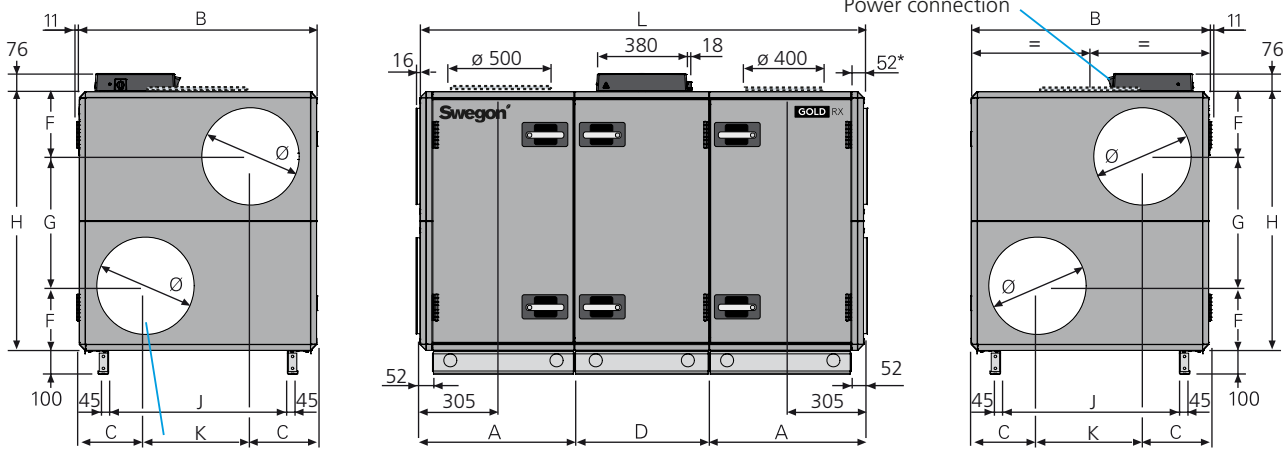
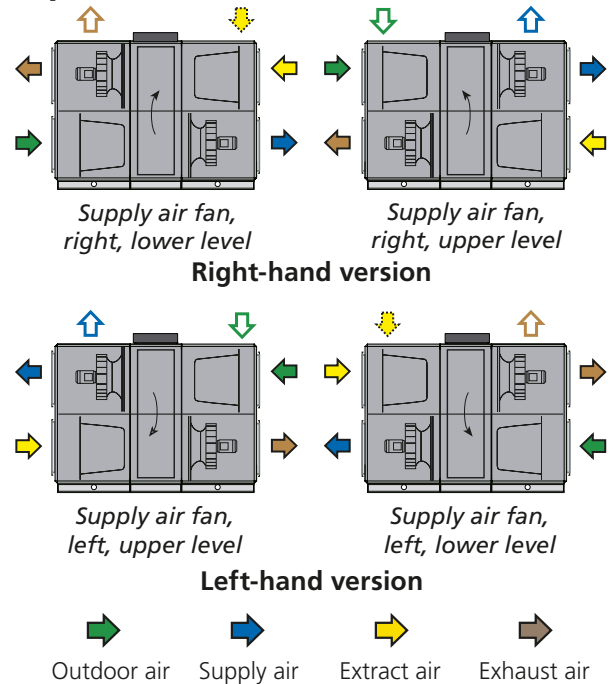

The illustration shows the connections for supply air fan, right-hand/lower level and left-hand/upper level. For supply air fan, right-hand/upper level and left-hand/lower level, the connections are mirror-inverted.

* The air handling unit is supplied without end connection panel if a duct accessory housed in an insulated casing will be connected. The AHU can also be supplied with full face end connection panel (accessory).

Size	A	B	C	D	F	G	H	J	K	L	Ø	Weight, kg
008	647.5	995	277.5	565	271	543	1085	749	440	1860	400	341-420

Division into sections for transport

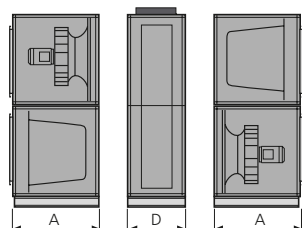

The unit can be divided into three sections at the building site.
Dimensions: See A and D in the table above.
Weight: A = 110-142 kg, D = 121-136 kg.

Power connection

Capacity variant 1:
 1-phase, 3-wire, 230 V -10/+15%, 50 Hz, 16 A or
 3-phase, 5-wire, 400 V -10/+15%, 50 Hz, 10 A
Capacity variant 2:
 3-phase, 5-wire, 400 V -10/+15%, 50 Hz, 10 A

Rated data per fan

Capacity variant 1:
 Motor shaft power: 1.15 kW,
 motor control system: 1 x 230 V, 50 Hz
Capacity variant 2:
 Motor shaft power: 1.6 kW,
 motor control system: 3 x 400 V, 50 Hz

Clear space for inspection

A clear space of 900 mm should be provided in front of the unit and at least 200 mm should be provided above the junction hood.

Sizing, installation, dimensions and weights

GOLD RX Top, rotary heat exchanger, size 008

Delivery and transport within the site

The GOLD RX Top 008 unit is produced in one variant in which all the components are arranged at their given physical location inside the unit.

The unit can also be delivered as L-concept with top fed duct connections in combination with side fed duct connections, see the section Description Air handling unit.

The air handling unit is supplied on a wooden pallet.

Prefitted base beams are obtainable as optional equipment.

Installation/duct connection options

A: All the duct connections are arranged from the top of the air handling unit (the unit must not be installed outdoors).

B: Specify right-hand or left-hand version when ordering. The version can be changed at the building site using the hand-held terminal. **Note:** Supply air filters and extract air filters have different dimensions and may need to be replaced for different filter classes.

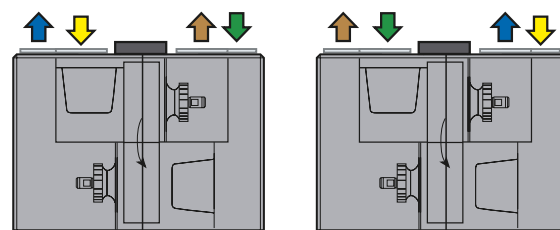

Left-hand version

Right-hand version

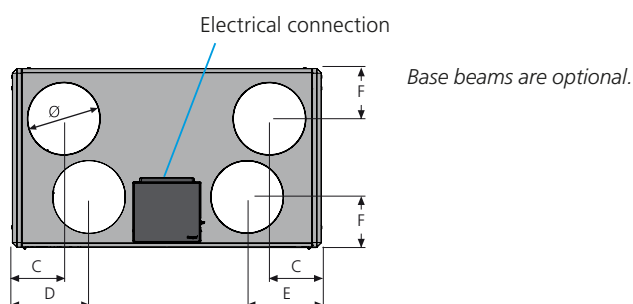
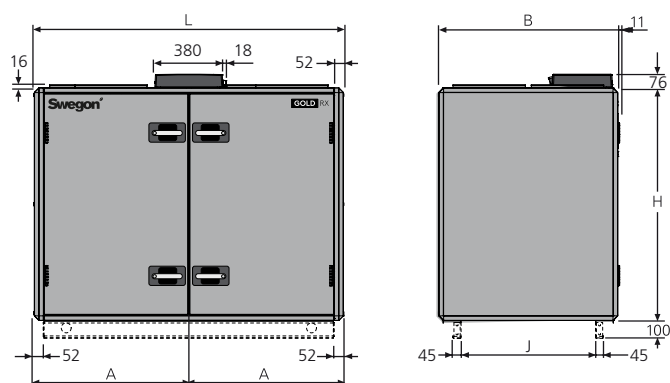
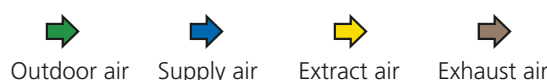

Size	A	B	C	D	E	F	H	J	L	Ø	Weight, kg
008	860	995	286	426	406	280	1295	749	1720	400	369-382

Clear space for inspection

A clear space of 900 mm should be provided in front of the unit and at least 200 mm should be provided above the junction hood.

Electrical connection

Capacity variant 1:

1-phase, 3-wire, 230 V -10/+15%, 50 Hz, 16 A or
3-phase, 5-wire, 400 V -10/+15%, 50 Hz, 10 A

Capacity variant 2:

3-phase, 5-wire, 400 V -10/+15%, 50 Hz, 10 A

Rated data per fan

Capacity variant 1:

Motor shaft power: 1.15 kW, motor control system: 1 x 230 V, 50 Hz

Capacity variant 2:

Motor shaft power: 1.6 kW, motor control system: 3 x 400 V, 50 Hz

Sizing, installation, dimensions and weights

GOLD RX, rotary heat exchanger, size 011

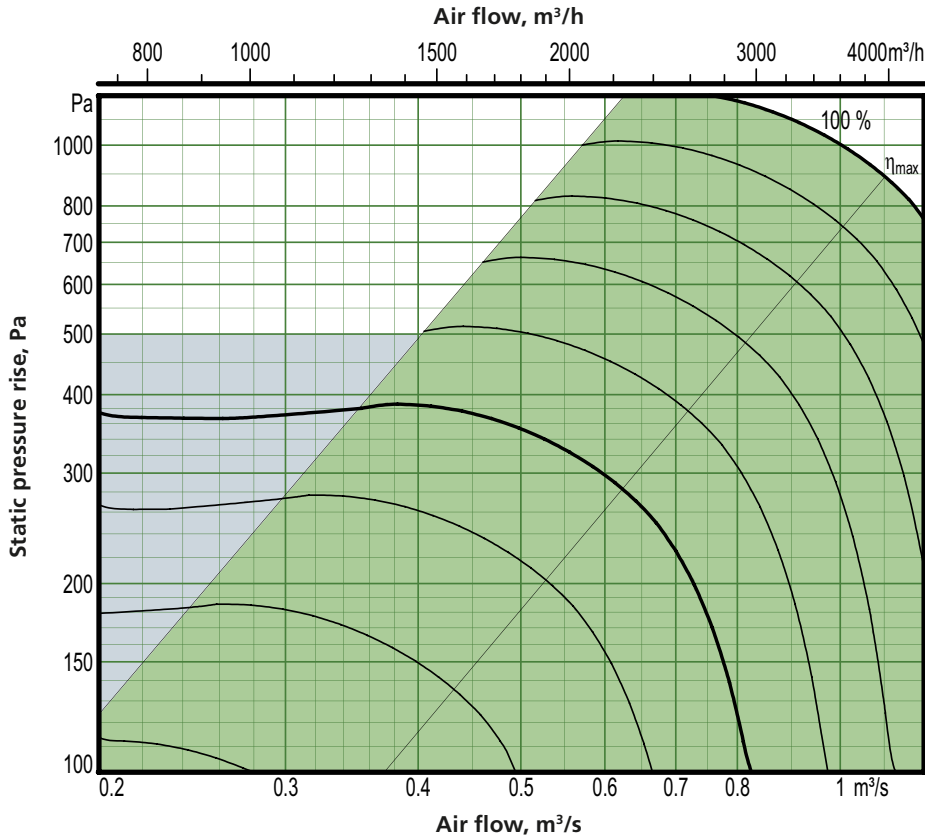

Motor shaft power: 1.6 kW (capacity variant 2)

- Recommended working range for sizing.
- If pressure regulation is used, the air flow can be regulated to zero.
- However this presupposes a certain static pressure drop in the ducting (approx. 50 Pa).

Min. and max. air flows

The flows specified refer to those that can be preset in the hand-held terminal. The practical flow limits are determined by the external pressure drop.

Size	Min. airflow (on airflow regulation)		Max. airflow	
	m ³ /h	m ³ /s	m ³ /h	m ³ /s
011	720	0.20	3960	1.10

Exact sizing can be carried out in the AHU Design air handling unit selection program

Sizing, installation, dimensions and weights

GOLD RX, rotary heat exchanger, size 011

Delivery and transport within the site

The GOLD RX 011 can be supplied as one single unit, or in a number of different combinations of unit sections from the factory, see the section: Description of the Air Handling Unit/Delivery Configuration RX/PX/CX, sizes 011-080.

The unit sections are jointed together/split by means of bolts. The electrical and control cables between the unit sections have quick-fit connectors.

The air handling unit/unit sections is/are delivered on wooden beams.

Duct connection options

A: Specify right-hand or left-hand version when ordering. If the air handling unit is supplied with all the end connection panels, the version can be changed at the building site using the hand-held terminal.

B: The arrangement of the functional sections can be vertically reversed. To be specified when placing an order, see the illustration to the right.

C: Specify upper fan outlet for upward air discharge when placing orders (Does not apply to units installed outdoors).

D: Specify whether the unit shall have an air intake from above for outdoor air or extract air when placing orders (Does not apply to units installed outdoors).

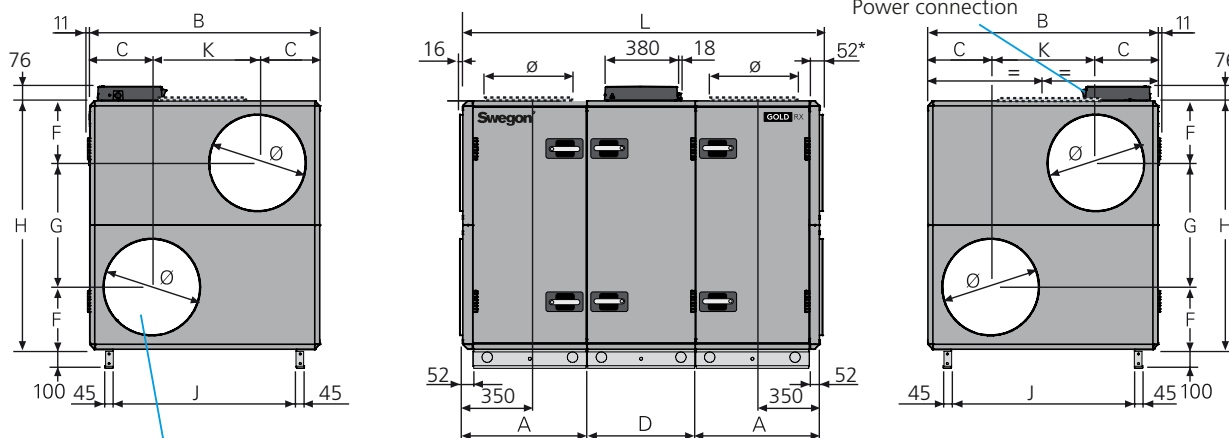
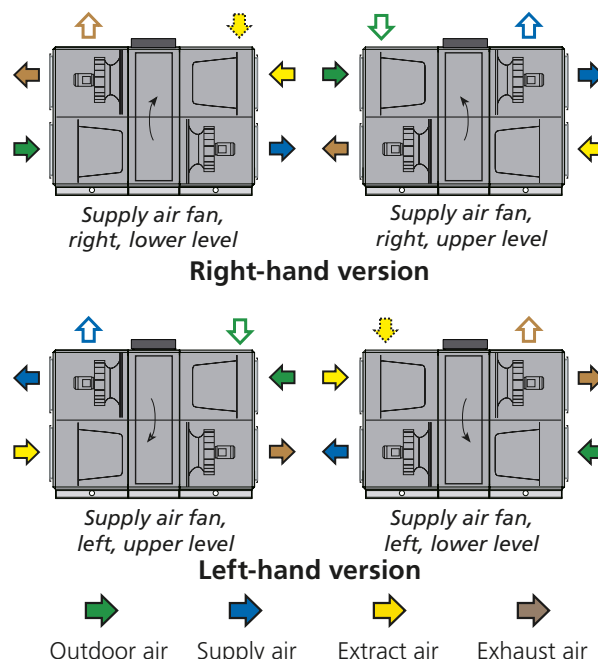

The illustration shows the connections for supply air fan, right-hand/lower level and left-hand/upper level.

For supply air fan, right-hand/upper level and left-hand/lower level, the connections are mirror-inverted.

* The air handling unit is supplied without end connection panel if a duct accessory housed in an insulated casing will be connected. The AHU can also be supplied with full face end connection panel (accessory).

Size	A	B	C	D	F	G	H	J	K	L	Ø	Weight, kg
011	647	1199	324	565	324	647	1295	953	551	1859	500	427-527

Division into sections for transport

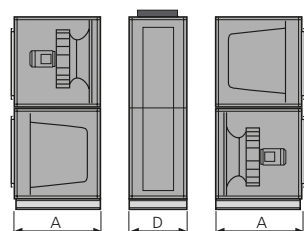

The unit can be divided into three sections at the building site.

Dimensions: See A and D in the table above.

Weight: A = 135-175 kg, D = 157-177 kg.

Power connection

Capacity variant 1:

1-phase, 3-wire cable, 230 V -10/+15%, 50 Hz, 16 A or 3-phase, 5-wire cable, 400 V -10/+15%, 50 Hz, 10 A

Capacity variant 2:

3-phase, 5-wire cable, 400 V -10/+15%, 50 Hz, 10 A

Rated data per fan

Capacity variant 1: Motor shaft power: 1.15 kW, motor control system: 1 x 230 V, 50 Hz

Capacity variant 2: Motor shaft power: 1.6 kW, motor control system: 3 x 400 V, 50 Hz

Clear space for inspection

A clear space of 800 mm should be provided in front of the unit and at least 200 mm should be provided above the junction hood.

Sizing, installation, dimensions and weights

GOLD RX Top, rotary heat exchanger, size 011

Delivery and transport within the site

The GOLD RX Top 011 can be supplied as one single unit, or in a number of different combinations of unit sections from the factory, see the section: Description of the Air Handling Unit. Filter/fan sections for RX and RX Top can be combined, see the section: Description of the Air Handling Unit. The unit sections are jointed together/split by means of bolts. The electrical and control cables between the unit sections have quick-fit connectors. The air handling unit/unit sections is/are delivered on wooden beams.

Duct connection options

- A:** All the duct connections are arranged from the top of the air handling unit (the unit must not be installed outdoors).
- B:** Specify right-hand or left-hand version when ordering. The version can be changed at the building site using the hand-held terminal. **Note:** Supply air filters and extract air filters have different dimensions and may need to be replaced for different filter classes.
- C:** The arrangement of the functional sections can be vertically reversed. To be specified when placing an order, see the illustration to the right.

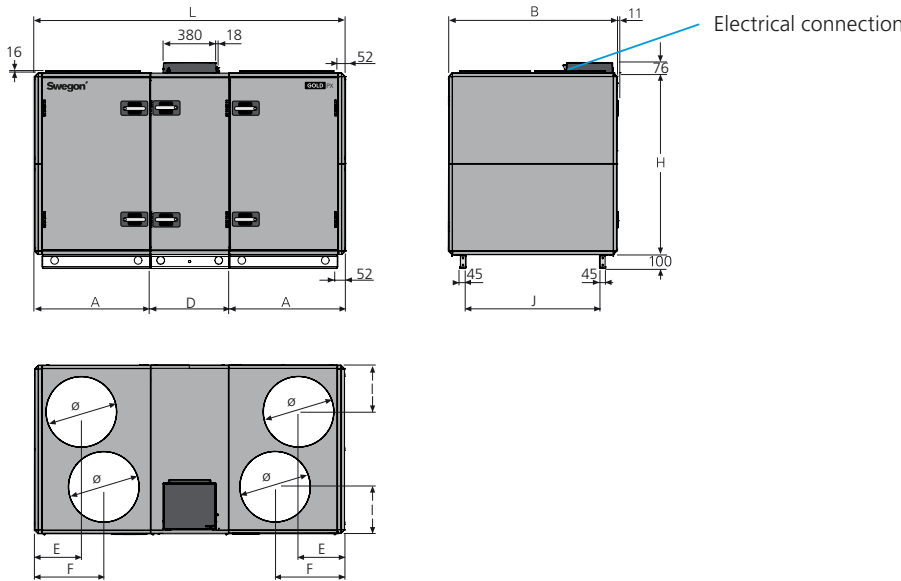
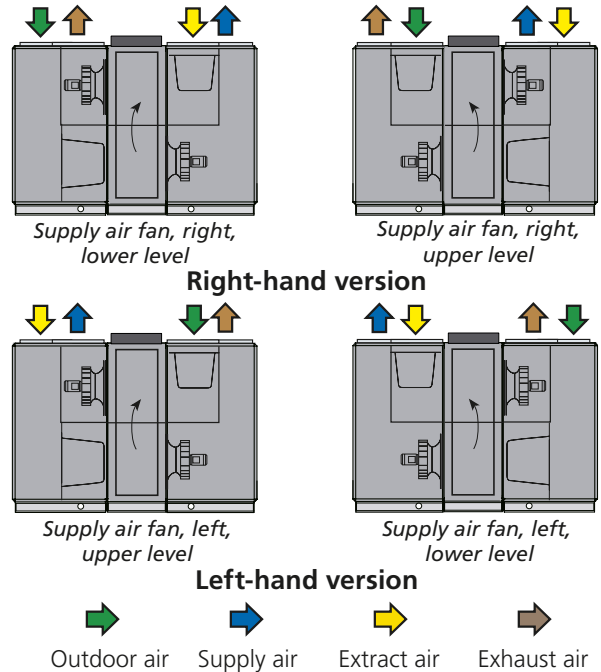

Size	A	B	D	E	F	H	I	J	L	Ø	Weight, kg
011	827	1199	565	332	500	1295	332	953	2219	500	527-549

Division into sections for transport to the site

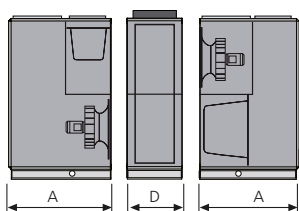

The unit can be divided into three sections at the building site.
Dimensions: See A and D in the table above.
Weight: A = 185-186 kg, D = 157-177 kg.

Clear space for inspection

A clear space of 800 mm should be provided in front of the unit and at least 200 mm should be provided above the junction hood.

Electrical connection

- Capacity variant 1:**
1-phase, 3-wire, 230 V -10/+15%, 50 Hz, 16 A or
3-phase, 5-wire, 400 V -10/+15%, 50 Hz, 10 A
- Capacity variant 2:**
3-phase, 5-wire, 400 V -10/+15%, 50 Hz, 10 A

Rated data per fan

- Capacity variant 1:**
Motor shaft power: 1.15 kW, motor control system: 1 x 230 V, 50 Hz
- Capacity variant 2:**
Motor shaft power: 1.6 kW, motor control system: 3 x 400 V, 50 Hz

Sizing, installation, dimensions and weights

GOLD RX, rotary heat exchanger, size 012

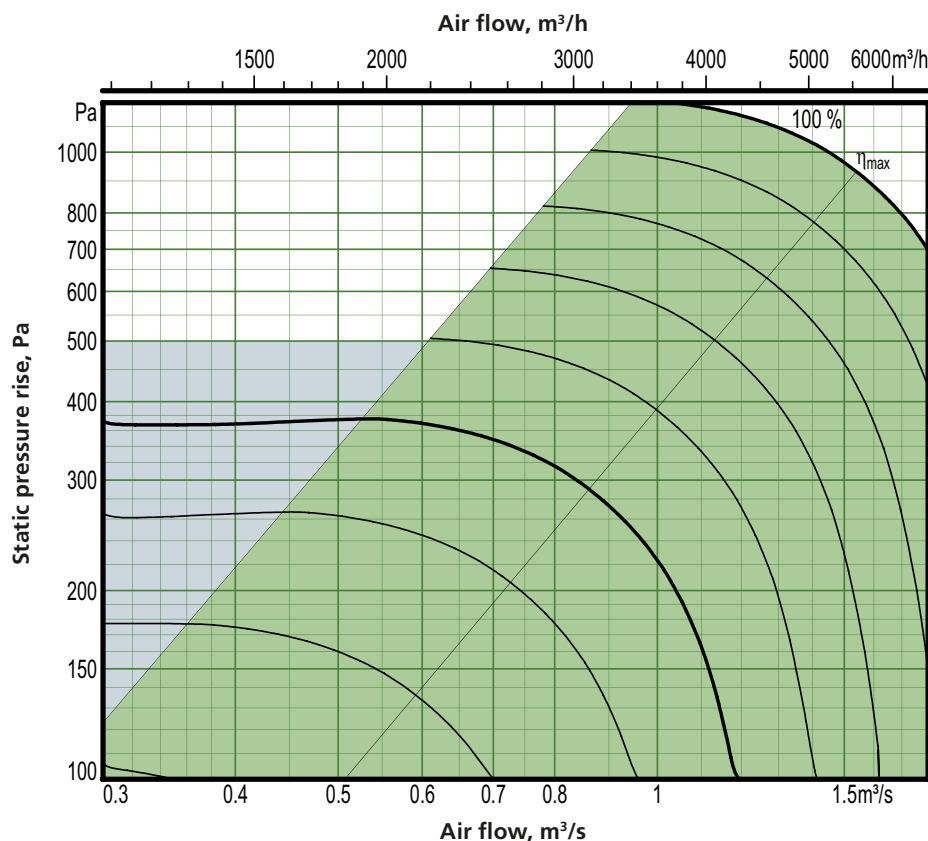

Motor shaft power: 2.4 kW (capacity variant 2)

- Recommended working range for sizing.
- If pressure regulation is used, the air flow can be regulated to zero.
- However this presupposes a certain static pressure drop in the ducting (approx. 50 Pa).

Min. and max. air flows

The flows specified refer to those that can be preset in the hand-held terminal. The practical flow limits are determined by the external pressure drop.

Size	Min. airflow (on airflow regulation)		Max. airflow	
	m ³ /h	m ³ /s	m ³ /h	m ³ /s
012	720	0.20	5040	1.40

Exact sizing can be carried out in the AHU Design air handling unit selection program

Sizing, installation, dimensions and weights

GOLD RX, rotary heat exchanger, size 012

Delivery and transport within the site

The GOLD RX 012 can be supplied as one single unit, or in a number of different combinations of unit sections from the factory, see the section: Description of the Air Handling Unit/ Delivery Configuration RX/PX/CX, sizes 011-080. The unit sections are jointed together/split by means of bolts. The electrical and control cables between the unit sections have quick-fit connectors. The air handling unit/unit sections is/are delivered on wooden beams.

Duct connection options

- A:** Specify right-hand or left-hand version when ordering. If the air handling unit is supplied with all the end connection panels, the version can be changed at the building site using the hand-held terminal.
- B:** The arrangement of the functional sections can be vertically reversed. To be specified when placing an order, see the illustration to the right.
- C:** Specify upper fan outlet for upward air discharge when placing orders (Does not apply to units installed outdoors).
- D:** Specify whether the unit shall have an air intake from above for outdoor air or extract air when placing orders (Does not apply to units installed outdoors).

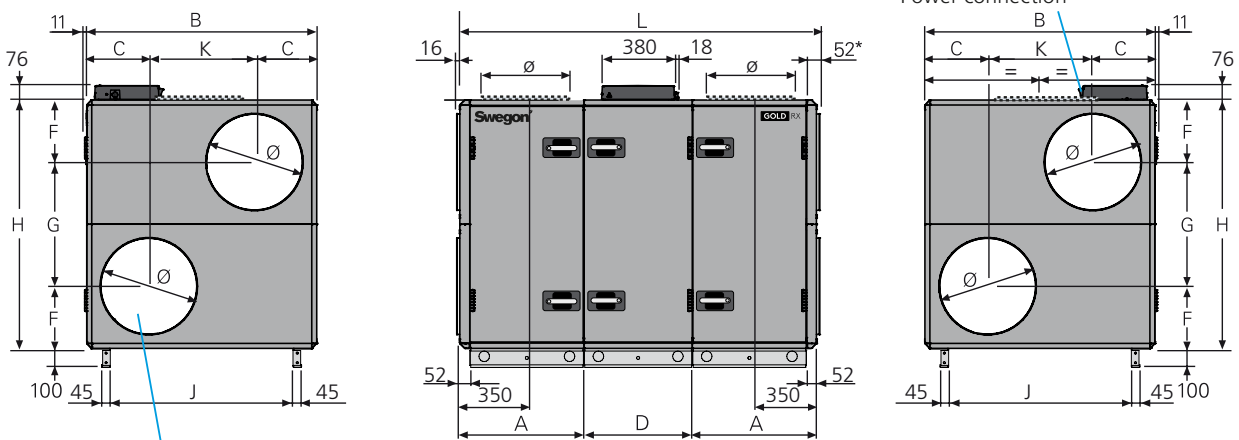
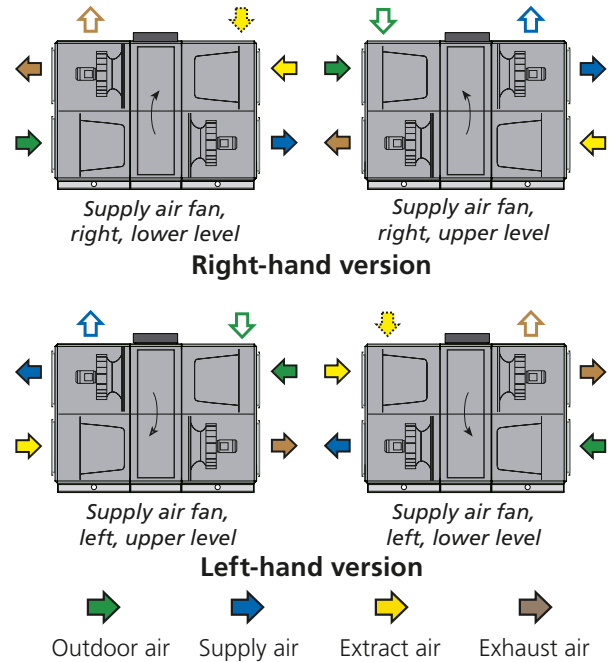

The illustration shows the connections for supply air fan, right-hand/lower level and left-hand/upper level. For supply air fan, right-hand/upper level and left-hand/lower level, the connections are mirror-inverted. * The air handling unit is supplied without end connection panel if a duct accessory housed in an insulated casing will be connected. The AHU can also be supplied with full face end connection panel (accessory).

Size	A	B	C	D	F	G	H	J	K	L	Ø	Weight, kg
012	647	1199	324	565	324	647	1295	953	551	1859	500	450-554

Division into sections for transport

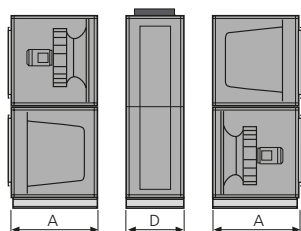

The unit can be divided into three sections at the building site. **Dimensions:** See A and D in the table above. **Weight:** A = 146-189 kg, D = 158-176 kg.

Clear space for inspection

A clear space of 800 mm should be provided in front of the unit and at least 200 mm should be provided above the junction hood.

Power connection

3-phase, 5-wire, 400 V -10/+15%, 50 Hz, 10 A

Rated data per fan

Motor shaft power: 2.4 kW (1.6 kW* or 2.4 kW), motor control system: 3 x 400 V, 50 Hz

*The motor control system limits the output power to the value specified.

Sizing, installation, dimensions and weights

GOLD RX Top, rotary heat exchanger, size 012

Delivery and transport within the site

The GOLD RX Top 012 can be supplied as one single unit, or in a number of different combinations of unit sections from the factory, see the section: Description of the Air Handling Unit. Filter/fan sections for RX and RX Top can be combined, see the section: Description of the Air Handling Unit.

The unit sections are jointed together/split by means of bolts. The electrical and control cables between the unit sections have quick-fit connectors.

The air handling unit/unit sections is/are delivered on wooden beams.

Duct connection options

A: All the duct connections are arranged from the top of the air handling unit (the unit must not be installed outdoors).

B: Specify right-hand or left-hand version when ordering. The version can be changed at the building site using the hand-held terminal. **Note:** Supply air filters and extract air filters have different dimensions and may need to be replaced for different filter classes.

C: The arrangement of the functional sections can be vertically reversed. To be specified when placing an order, see the illustration to the right.

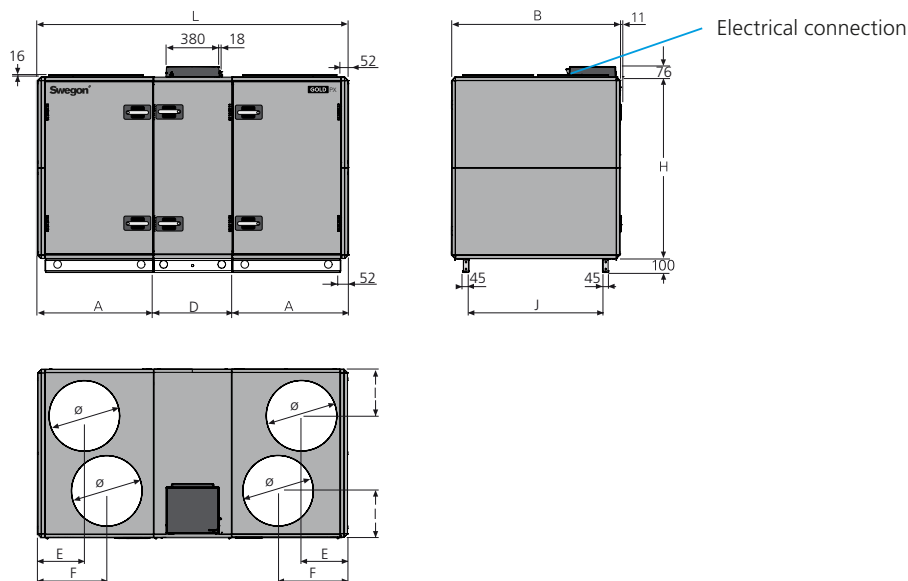
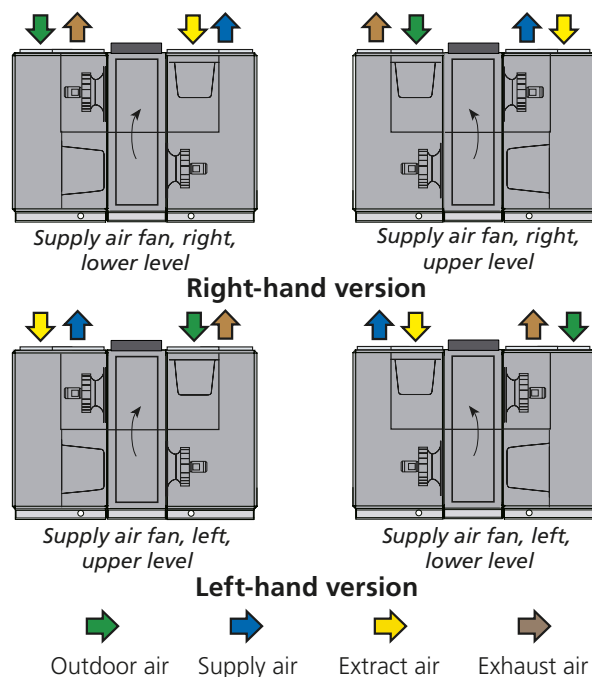

Size	A	B	D	E	F	H	I	J	L	Ø	Weight, kg
012	827	1199	565	332	500	1295	332	953	2219	500	550-576

Division into sections for transport

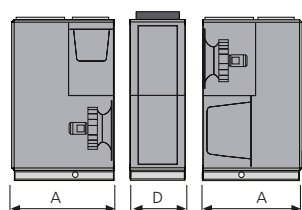

The unit can be divided into three sections at the building site.

Dimensions: See A and D in the table above.

Weight: A = 196-200 kg, D = 158-176 kg.

Clear space for inspection

A clear space of 800 mm should be provided in front of the unit and at least 200 mm should be provided above the junction hood.

Electrical connection

3-phase, 5-wire, 400 V -10/+15%, 50 Hz, 10 A

Rated data per fan

Motor shaft power: 2.4 kW (1.6 kW* or 2.4 kW), motor control system: 3 x 400 V, 50 Hz

*The motor control system limits the output power to the value specified.

Sizing, installation, dimensions and weights

GOLD RX, rotary heat exchanger, size 014/020

Size 014 (Extract air fan size 020 can be selected, see the next page)

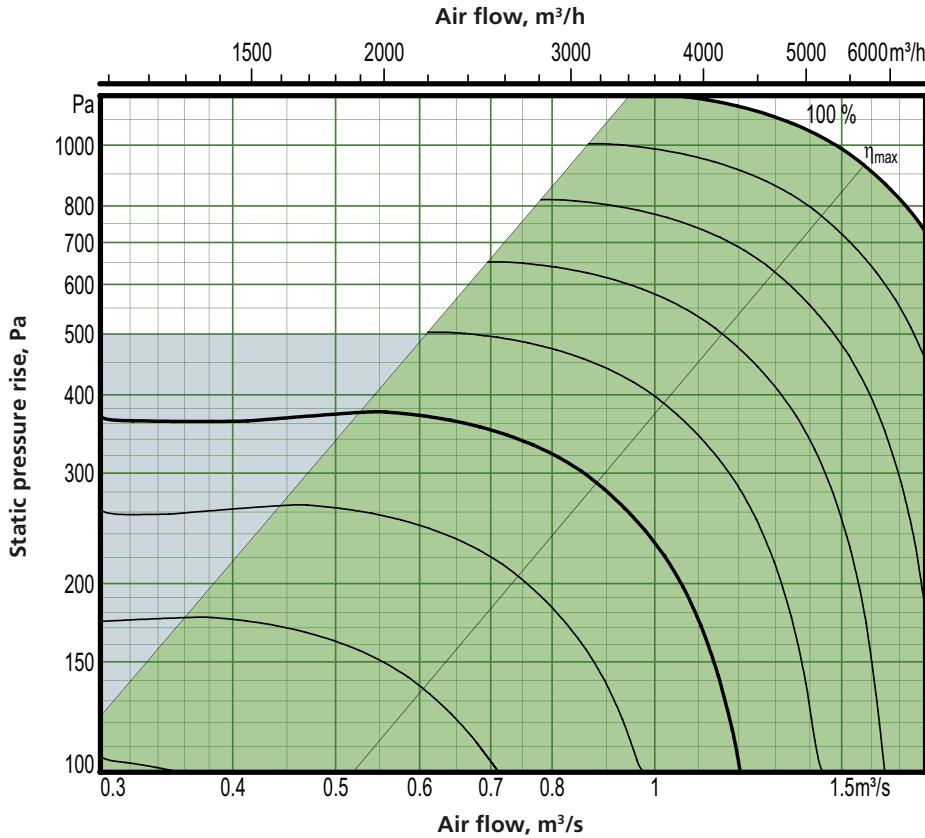

Motor shaft power: 2.4 kW (capacity variant 2)

- Recommended working range for sizing.
- If pressure regulation is used, the air flow can be regulated to zero.
- However this presupposes a certain static pressure drop in the ducting (approx. 50 Pa).

Min. and max. airflows

The flows specified refer to those that can be preset in the hand-held terminal. The practical flow limits are determined by the external pressure drop.

Size	Min. airflow (on airflow regulation)		Max. airflow	
	m³/h	m³/s	m³/h	m³/s
014	720	0.20	5940	1.65

Exact sizing can be carried out in the AHU Design air handling unit selection program

Sizing, installation, dimensions and weights

GOLD RX, rotary heat exchanger, size 014/020

Size 020 (Extract air fan size 014 can be selected, see the previous page)

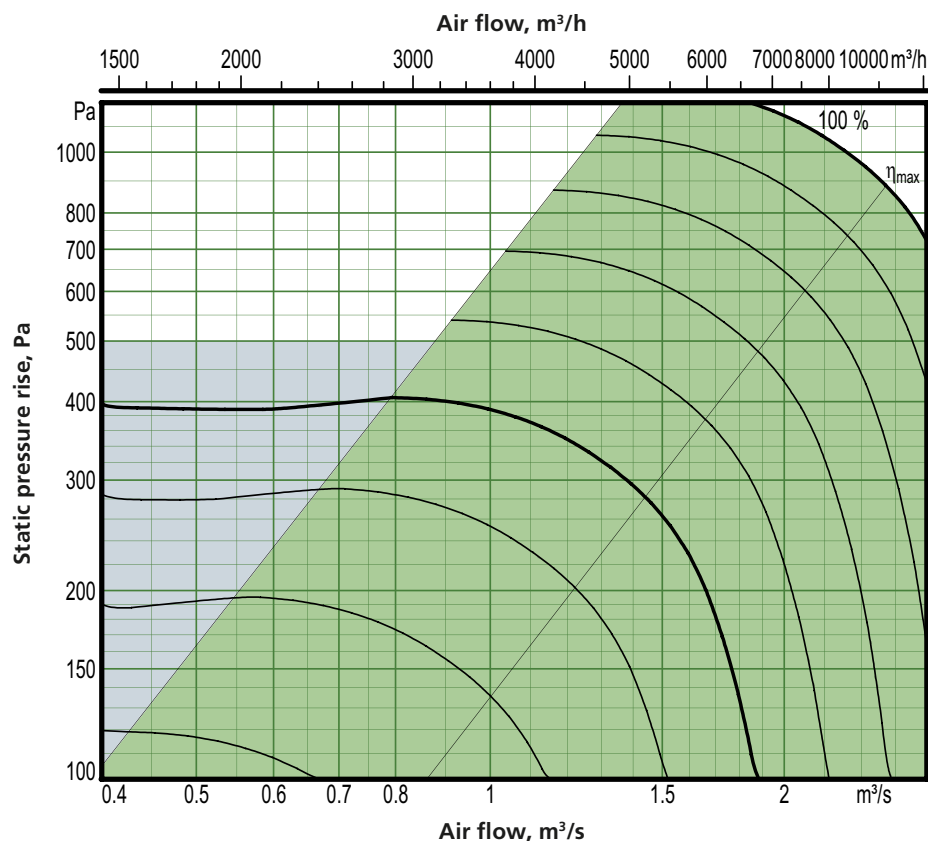

Motor shaft power: 3.4 kW (capacity variant 2)

- Recommended working range for sizing.
- If pressure regulation is used, the air flow can be regulated to zero.
- However this presupposes a certain static pressure drop in the ducting (approx. 50 Pa).

Min. and max. airflows

The flows specified refer to those that can be preset in the hand-held terminal. The practical flow limits are determined by the external pressure drop.

Size	Min. airflow (on airflow regulation)		Max. airflow	
	m³/h	m³/s	m³/h	m³/s
020	1080	0.30	7560	2.1

Exact sizing can be carried out in the AHU Design air handling unit selection program

Sizing, installation, dimensions and weights

GOLD RX, rotary heat exchanger, size 014/020

Delivery and transport within the site

The GOLD RX 014/020 can be supplied as one single unit, or in a number of different combinations of unit sections from the factory, see the section: Description of the Air Handling Unit. Filter/fan sections for RX and RX Top can be combined, see the section: Description of the Air Handling Unit.

The unit sections are jointed together/split by means of bolts. The electrical and control cables between the unit sections have quick-fit connectors.

The air handling unit/unit sections is/are delivered on wooden beams.

Duct connection options

A: Specify right-hand or left-hand version when ordering. If the air handling unit is supplied with all the end connection panels, the version can be changed at the building site using the hand-held terminal. **NOTE!** Supply and extract air fans can be selected in different sizes/capacity variants, which must be taken into account.

B: The arrangement of the functional sections can be vertically reversed. To be specified when placing an order, see the illustration to the right.

C: Specify upper fan outlet for upward air discharge when placing orders (not for outdoor units).

D: Specify whether the unit shall have an air intake from above for outdoor air or extract air when placing orders (does not apply to units installed outdoors).

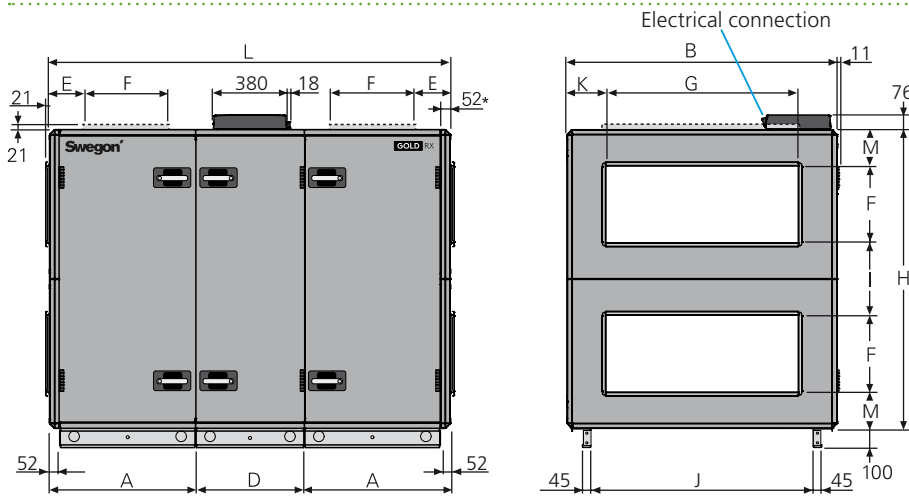
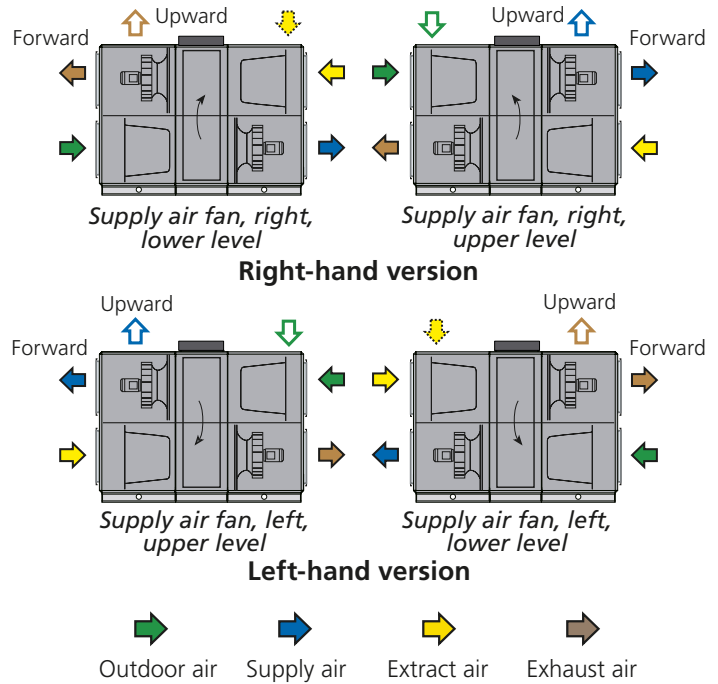

* The air handling unit is supplied without end connection panel if a duct accessory housed in an insulated casing will be connected. The AHU can also be supplied with full face end connection panel (accessory).

Size	A	B	D	E	F	G	H	I	J	K	L	M	Weight, kg
014/020	757,5	1400	565	205	400	1000	1551	375	1154	200	2080	188	572-746

Division into sections for transport

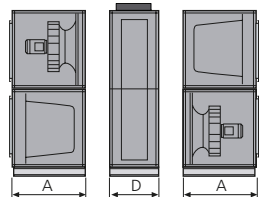

The unit can be divided into three sections at the building site.

Dimensions: See A and D in the table above.

Weight: A = 190-264 kg, D = 192-218 kg.

Rated data per fan

Size 014: Motor shaft power: 2.4 kW (1.6 kW* or 2.4 kW), motor control system: 3 x 400 V, 50 Hz
*The motor control system limits the output power to the value specified.

Size 020: Motor shaft power: 2.4 kW alt. 3.4 kW, motor control system: 3 x 400 V, 50 Hz

Clear space for inspection

A clear space of 900 mm should be provided in front of the unit and at least 200 mm should be provided above the junction hood.

Electrical connection

See table Electrical data at the end of this section.

Sizing, installation, dimensions and weights

GOLD RX Top, rotary heat exchanger, size 014/020

Delivery and transport within the site

The GOLD RX Top 014/020 can be supplied as one single unit, or in a number of different combinations of unit sections from the factory, see the section: Description of the Air Handling Unit. Filter/fan sections for RX and RX Top can be combined, see the section: Description of the Air Handling Unit.

The unit sections are jointed together/split by means of bolts. The electrical and control cables between the unit sections have quick-fit connectors.

The air handling unit/unit sections is/are delivered on wooden beams.

Duct connection options

A: All the duct connections are arranged from the top of the air handling unit (the unit must not be installed outdoors).

B: Specify right-hand or left-hand version when ordering. The version can be changed at the building site using the hand-held terminal. **Note:** Supply air filters and extract air filters have different dimensions and may need to be replaced for different filter classes. Supply and extract air fans can be selected in different sizes/capacity variants, which must be taken into account.

C: The arrangement of the functional sections can be vertically reversed. To be specified when placing an order, see the illustration to the right.

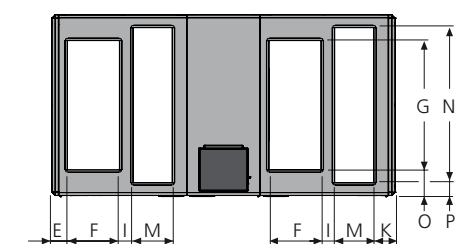
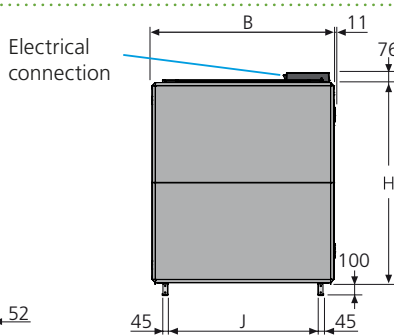
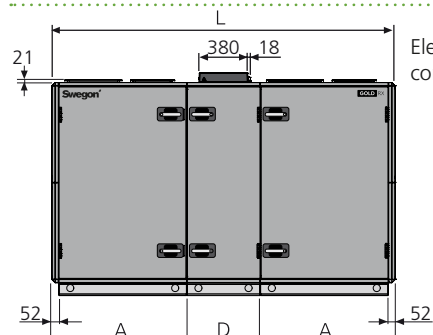
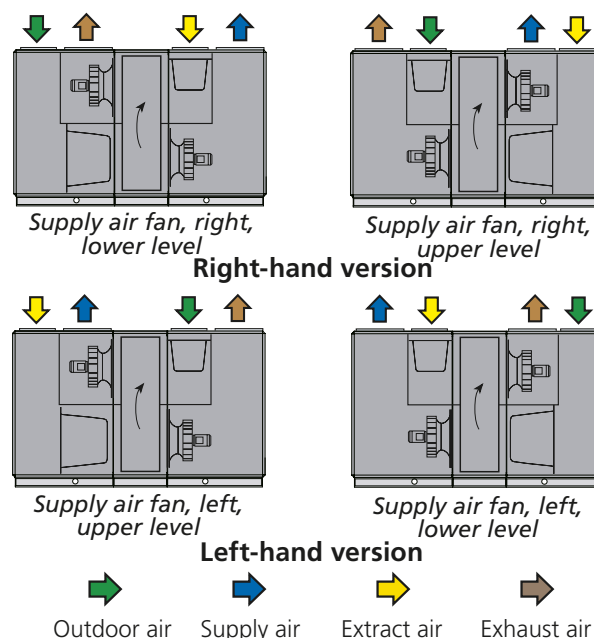

View from above. Shows the air handling unit's duct connections for supply air fan right up and left down

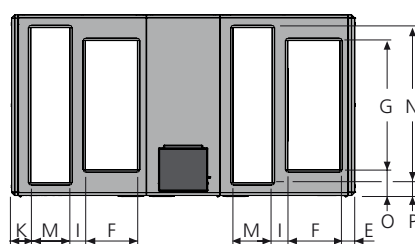

View from above. Shows the air handling unit's duct connections for supply air fan right down and left up

Size	A	B	D	E	F	G	H	I	J	K	L	M	N	O	P	Weight, kg
014/020	1039	1400	565	120	400	1000	1551	106	1154	165	2643	300	1200	200	100	726-832

Division into sections for transport

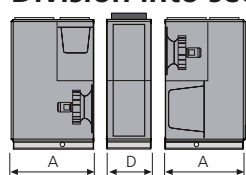

The unit can be divided into three sections at the building site.

Dimensions: See A and D in the table above.

Weight: A = 267-307 kg, D = 192-218 kg.

Rated data per fan

Size 014: Motor shaft power: 2.4 kW (1.6 kW* or 2.4 kW), motor control system: 3 x 400 V, 50 Hz
*The motor control system limits the output power to the value specified.

Size 020: Motor shaft power 2.4 kW alt. 3.4 kW, motor control system: 3 x 400 V, 50 Hz

Clear space for inspection

A clear space of 1000 mm should be provided in front of the unit and at least 200 mm should be provided above the junction hood.

Electrical connection

See table Electrical data at the end of this section.

Sizing, installation, dimensions and weights

GOLD RX, rotary heat exchanger, size 025/030

Size 025 (Extract air fan size 030 can be selected, see the next page)

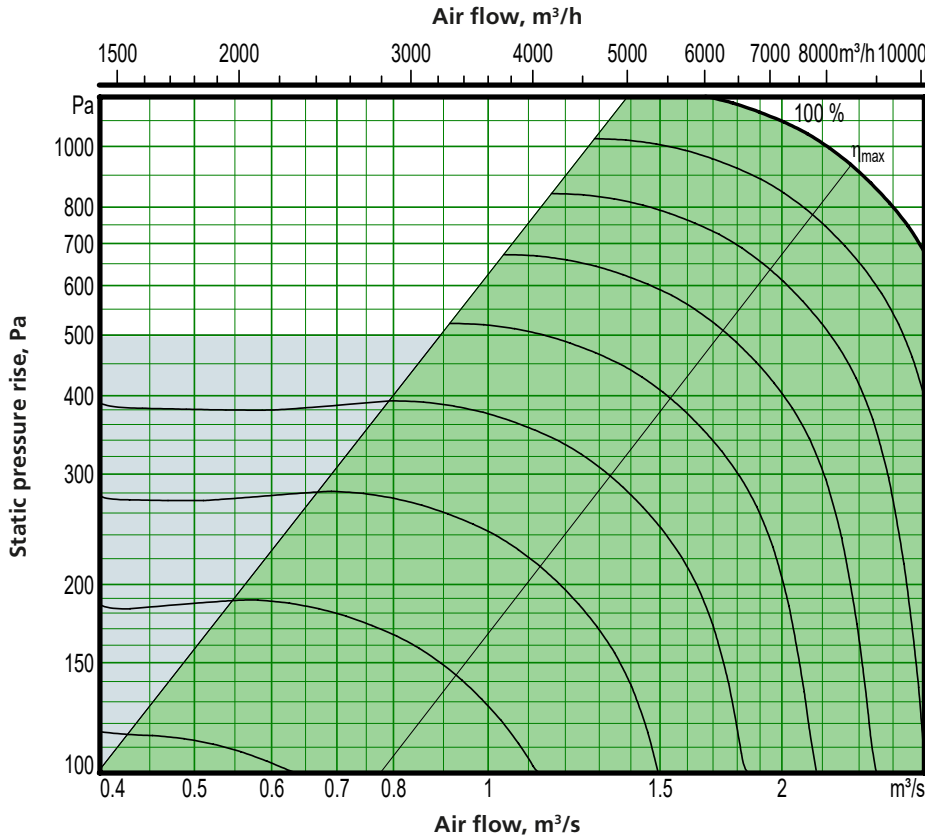

Motor shaft power: 3.4 kW (capacity variant 2)

- Recommended working range for sizing.
- If pressure regulation is used, the air flow can be regulated to zero.
- However this presupposes a certain static pressure drop in the ducting (approx. 50 Pa).

Min. and max. airflows

The flows specified refer to those that can be preset in the hand-held terminal. The practical flow limits are determined by the external pressure drop.

Size	Min. airflow (on airflow regulation)		Max. airflow	
	m³/h	m³/s	m³/h	m³/s
025	1080	0.30	9000	2.50

Exact sizing can be carried out in the AHU Design air handling unit selection program

Sizing, installation, dimensions and weights

GOLD RX, rotary heat exchanger, size 025/030

Size 030 (Extract air fan size 025 can be selected, see the previous page)

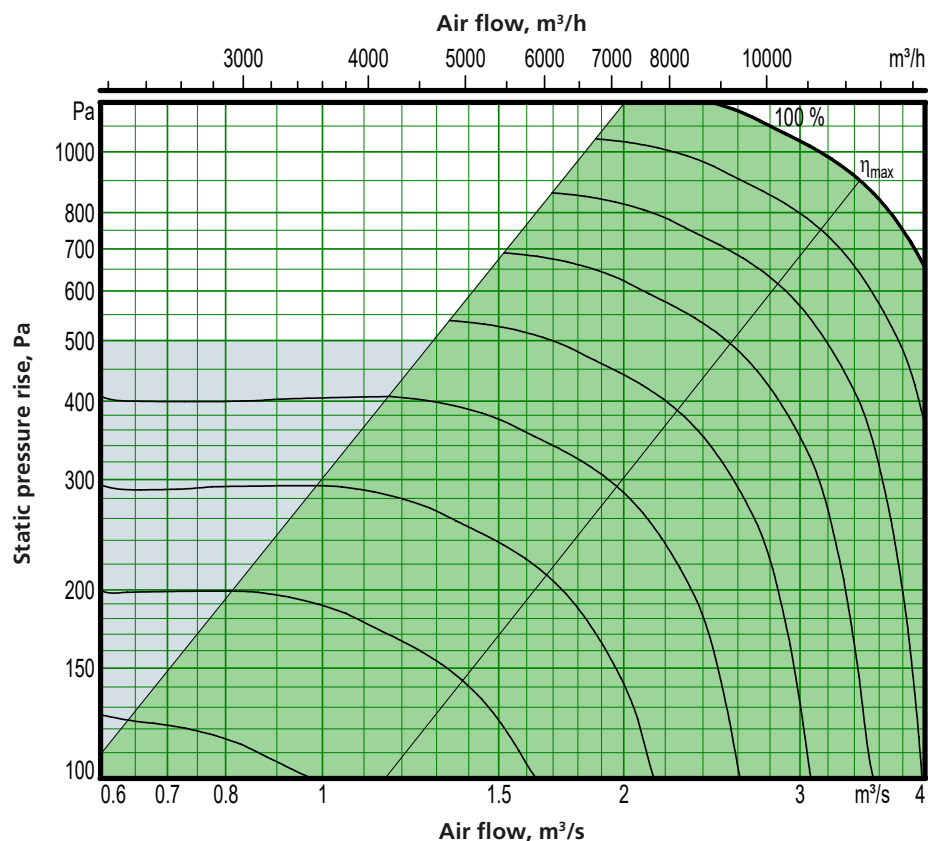

Motor shaft power: 5.0 kW (capacity variant 2)

- Recommended working range for sizing.
- If pressure regulation is used, the air flow can be regulated to zero.
- However this presupposes a certain static pressure drop in the ducting (approx. 50 Pa).

Min. and max. airflows

The flows specified refer to those that can be preset in the hand-held terminal. The practical flow limits are determined by the external pressure drop.

Size	Min. airflow (on airflow regulation)		Max. airflow	
	m³/h	m³/s	m³/h	m³/s
030	1800	0.50	11520	3.20

Exact sizing can be carried out in the AHU Design air handling unit selection program

Sizing, installation, dimensions and weights

GOLD RX, rotary heat exchanger, size 025/030

Delivery and transport within the site

The GOLD RX 025/030 can be supplied as one single unit, or in a number of different combinations of unit sections from the factory, see the section: Description of the Air Handling Unit. Filter/fan sections for RX and RX Top can be combined, see the section: Description of the Air Handling Unit.

The unit sections are jointed together/split by means of bolts. The electrical and control cables between the unit sections have quick-fit connectors.

The air handling unit/unit sections is/are delivered on wooden beams.

Duct connection options

A: Specify right-hand or left-hand version when ordering. If the air handling unit is supplied with all the end connection panels, the version can be changed at the building site using the hand-held terminal. **NOTE!** Supply and extract air fans can be selected in different sizes/capacity variants, which must be taken into account.

B: The arrangement of the functional sections can be vertically reversed. To be specified when placing an order, see the illustration to the right.

C: Specify upper fan outlet for upward air discharge when placing orders (not for outdoor units).

D: Specify whether the unit shall have an air intake from above for outdoor air or extract air when placing orders (does not apply to units installed outdoors).

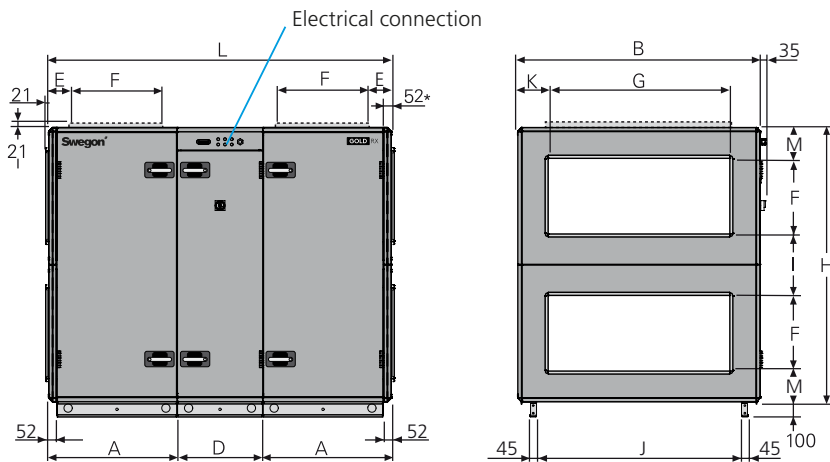
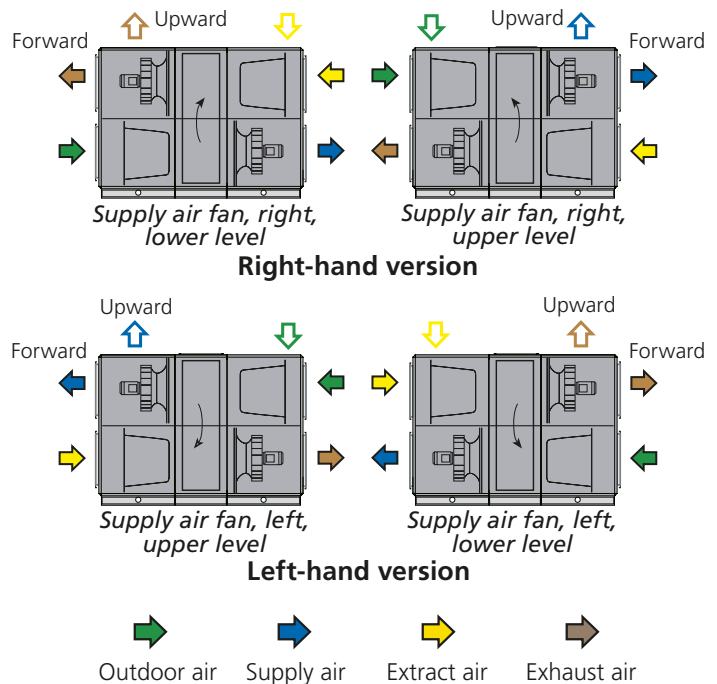

* The air handling unit is supplied without end connection panel if a duct accessory housed in an insulated casing will be connected. The AHU can also be supplied with full face end connection panel (accessory).

Size	A	B	D	E	F	G	H	I	J	K	L	M	Weight, kg
025/030	848	1600	565	200	500	1200	1811	405	1354	200	2261	203	744-971

Division into sections for transport

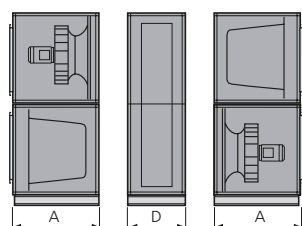

The unit can be divided into three sections at the building site.

Dimensions: See A and D in the table above.

Weight: A = 249-345 kg, D = 246-281 kg.

Clear space for inspection

A clear space of 900 mm should be provided in front of the unit.

Rated data per fan

Size 025: Motor shaft power 2.4 kW alt. 3.4 kW, motor control system: 3 x 400 V, 50 Hz
 Size 030: Motor shaft power: 4.0 kW alt. 5.0 kW, motor control system: 3 x 400 V, 50 Hz

Electrical connection

See table Electrical data at the end of this section.

Sizing, installation, dimensions and weights

GOLD RX Top, rotary heat exchanger, size 025/030

Delivery and transport within the site

The GOLD RX Top 025/030 can be supplied as one single unit, or in a number of different combinations of unit sections from the factory, see the section: Description of the Air Handling Unit. Filter/fan sections for RX and RX Top can be combined, see the section: Description of the Air Handling Unit.

The unit sections are jointed together/split by means of bolts. The electrical and control cables between the unit sections have quick-fit connectors.

The air handling unit/unit sections is/are delivered on wooden beams.

Duct connection options

A: All the duct connections are arranged from the top of the air handling unit (the unit must not be installed outdoors).

B: Specify right-hand or left-hand version when ordering. The version can be changed at the building site using the hand-held terminal. **Note:** Supply air filters and extract air filters have different dimensions and may need to be replaced for different filter classes. Supply and extract air fans can be selected in different sizes/capacity variants, which must be taken into account.

C: The arrangement of the functional sections can be vertically reversed. To be specified when placing an order, see the illustration to the right.

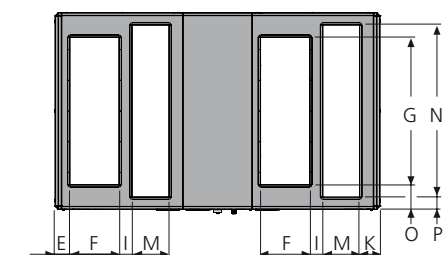
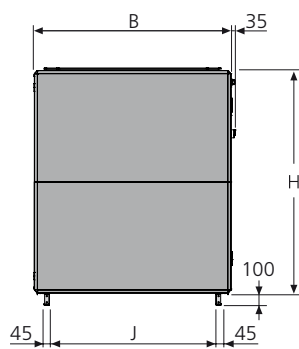
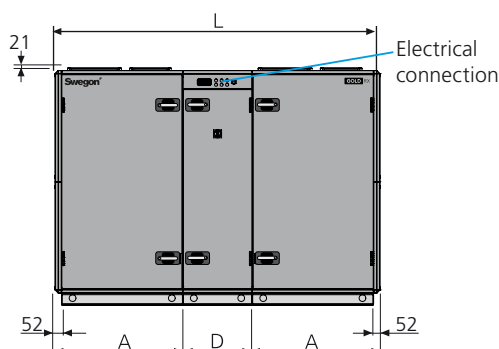
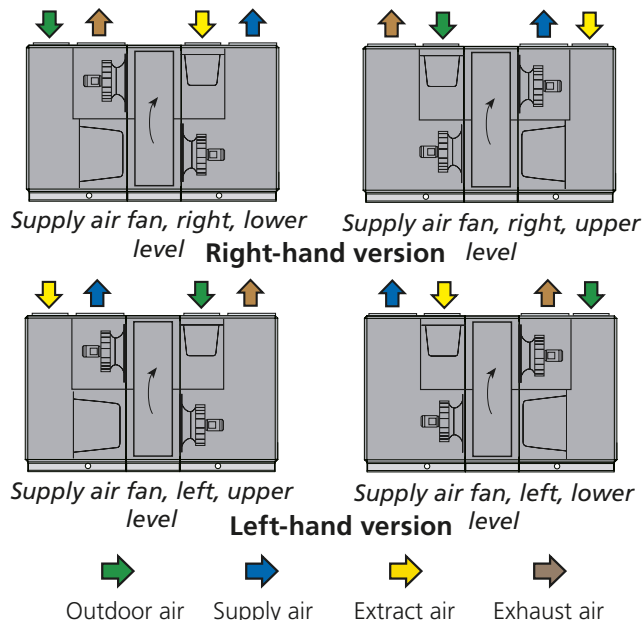

View from above. Shows the air handling unit's duct connections for supply air fan right up and left down

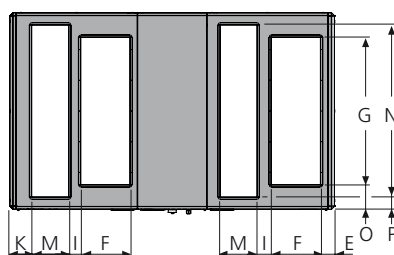

View from above. Shows the air handling unit's duct connections for supply air fan right down and left up

Size	A	B	D	E	F	G	H	I	J	K	L	M	N	O	P	Weight, kg
025/030	1039	1600	565	120	400	1200	1811	106	1354	165	2643	300	1400	200	100	884-1033

Division into sections for transport

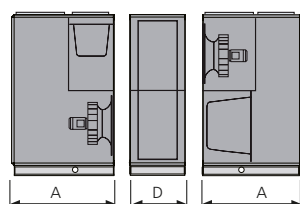

The unit can be divided into three sections at the building site.

Dimensions: See A and D in the table above.

Weight: A = 319-376 kg, D = 246-281 kg.

Clear space for inspection

A clear space of 1,000 mm should be provided in front of the unit.

Rated data per fan

Size 025: Motor shaft power 2.4 kW alt. 3.4 kW, motor control system: 3 x 400 V, 50 Hz

Size 030: Motor shaft power: 4.0 kW alt. 5.0 kW, motor control system: 3 x 400 V, 50 Hz

Electrical connection

See table Electrical data at the end of this section.

Sizing, installation, dimensions and weights

GOLD RX, rotary heat exchanger, size 035/040

Size 035 (Extract air fan size 040 can be selected, see the next page)

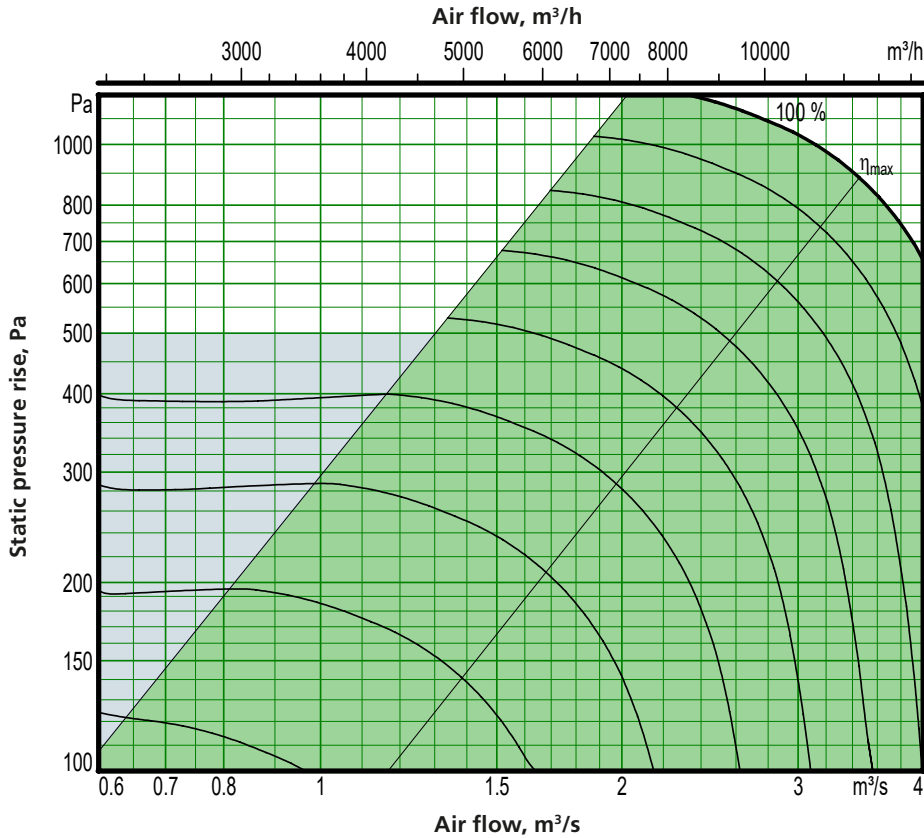

Motor shaft power: 5.0 kW (capacity variant 2)

- Recommended working range for sizing.
- If pressure regulation is used, the air flow can be regulated to zero.
- However this presupposes a certain static pressure drop in the ducting (approx. 50 Pa).

Min. and max. airflows

The flows specified refer to those that can be preset in the hand-held terminal. The practical flow limits are determined by the external pressure drop.

Size	Min. airflow (on airflow regulation)		Max. airflow	
	m³/h	m³/s	m³/h	m³/s
035	1800	0.50	14040	3.90

Exact sizing can be carried out in the AHU Design air handling unit selection program

Sizing, installation, dimensions and weights

GOLD RX, rotary heat exchanger, size 035/040

Size 040 (Extract air fan size 035 can be selected, see the previous page)

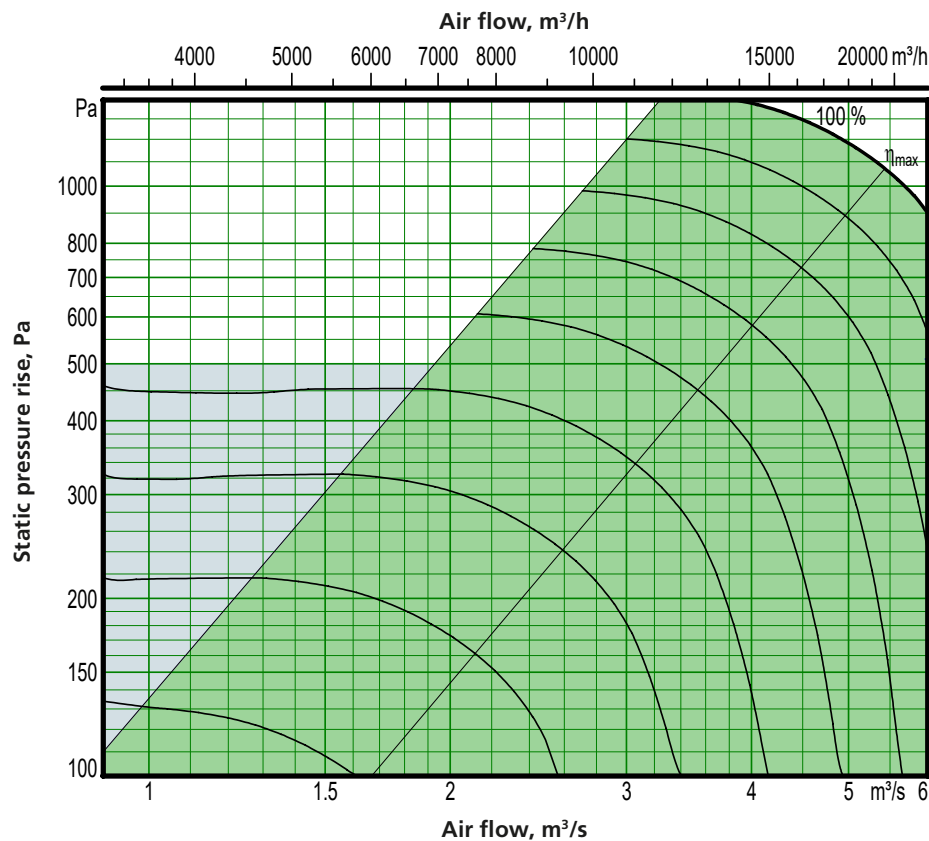

Motor shaft power: 10 kW (capacity variant 2)

- Recommended working range for sizing.
- If pressure regulation is used, the air flow can be regulated to zero.
- However this presupposes a certain static pressure drop in the ducting (approx. 50 Pa).

Min. and max. airflows

The flows specified refer to those that can be preset in the hand-held terminal. The practical flow limits are determined by the external pressure drop.

Size	Min. airflow (on airflow regulation)		Max. airflow	
	m ³ /h	m ³ /s	m ³ /h	m ³ /s
040	2700	0.75	18000	5.00

Exact sizing can be carried out in the AHU Design air handling unit selection program

Sizing, installation, dimensions and weights

GOLD RX, rotary heat exchanger, size 035/040

Delivery and transport within the site

The GOLD RX 035/040 can be supplied as one single unit, or in a number of different combinations of unit sections from the factory, see the section: Description of the Air Handling Unit/Delivery Configuration RX/PX/CX, sizes 011-080.

The unit sections are joined together/split by means of bolts. The electrical and control cables between the unit sections have quick-fit connectors.

The air handling unit/unit sections is/are delivered on wooden beams.

Duct connection options

A: Specify right-hand or left-hand version when ordering. If the air handling unit is supplied with all the end connection panels, the version can be changed at the building site using the hand-held terminal. **Note:** Supply and extract air fans can be selected in different sizes/capacity variants, which must be taken into account.

B: The arrangement of the functional sections can be vertically reversed. To be specified when placing an order, see the illustration to the right.

C: Specify upper fan outlet for upward air discharge when placing orders (not for outdoor units).

D: Specify whether the unit shall have an air intake from above for outdoor air or extract air when placing orders (Does not apply to units installed outdoors).

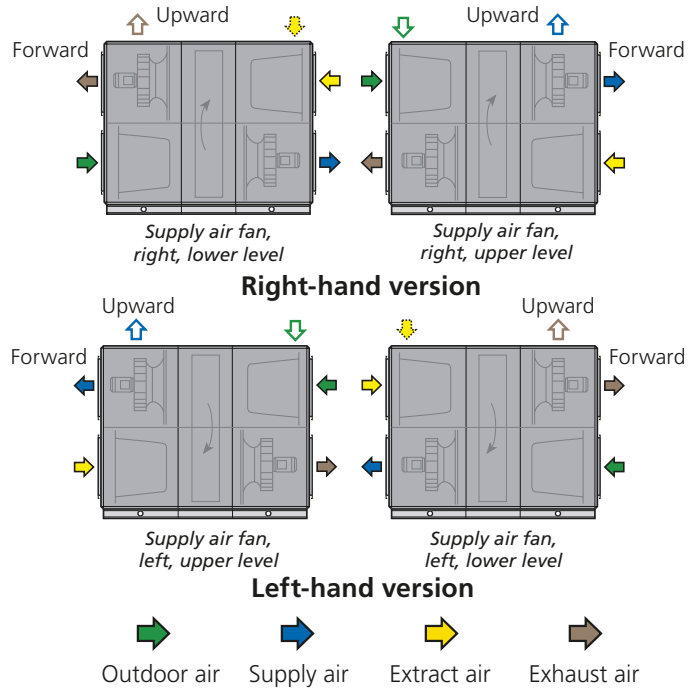

Power connection

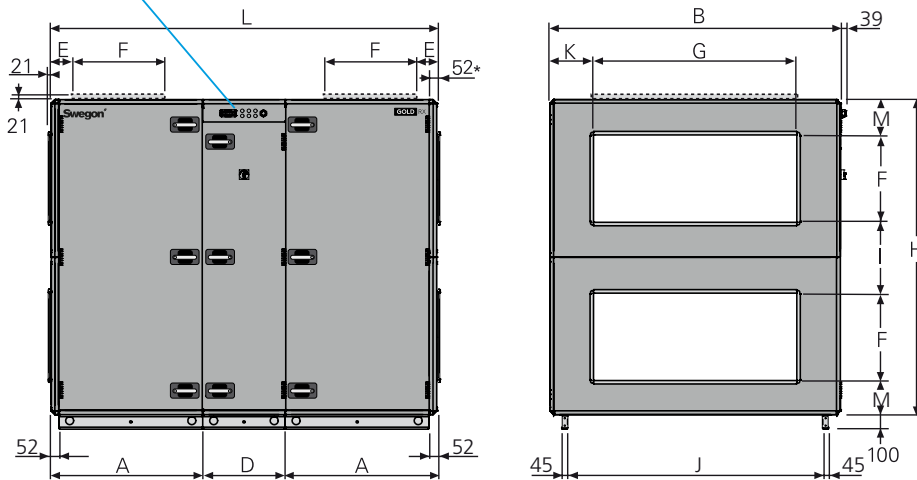

* The air handling unit is supplied without end connection panel if a duct accessory housed in an insulated casing will be connected. The AHU can also be supplied with full face end connection panel (accessory).

Size	A	B	D	E	F	G	H	I	J	K	L	M	Weight, kg
035/040	1038.5	1990	565	245	600	1400	2159	479	1744	295	2642	240	1096-1405

Division into sections for transport

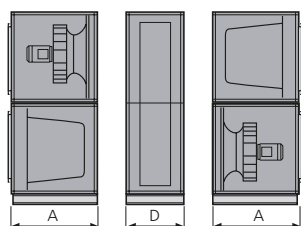

The unit can be divided into three sections at the building site.

Dimensions: See A and D in the table above.

Weight: A = 377-504 kg, D = 342-397 kg.

Clear space for inspection

A clear space of 1,100 mm should be provided in front of the unit.

Rated data per fan

Size 035: Motor shaft power: 4.0 kW alt. 5.0 kW, motor control system, 3 x 400 V, 50 Hz
 Size 040: Motor shaft power: 6.5 kW alt. 10 kW, motor control system: 3 x 400 V, 50 Hz

Electrical connection

See table Electrical data at the end of this section.

Sizing, installation, dimensions and weights

GOLD RX, rotary heat exchanger, size 050/060

Size 050 (Extract air fan size 060 can be selected, see the next page)

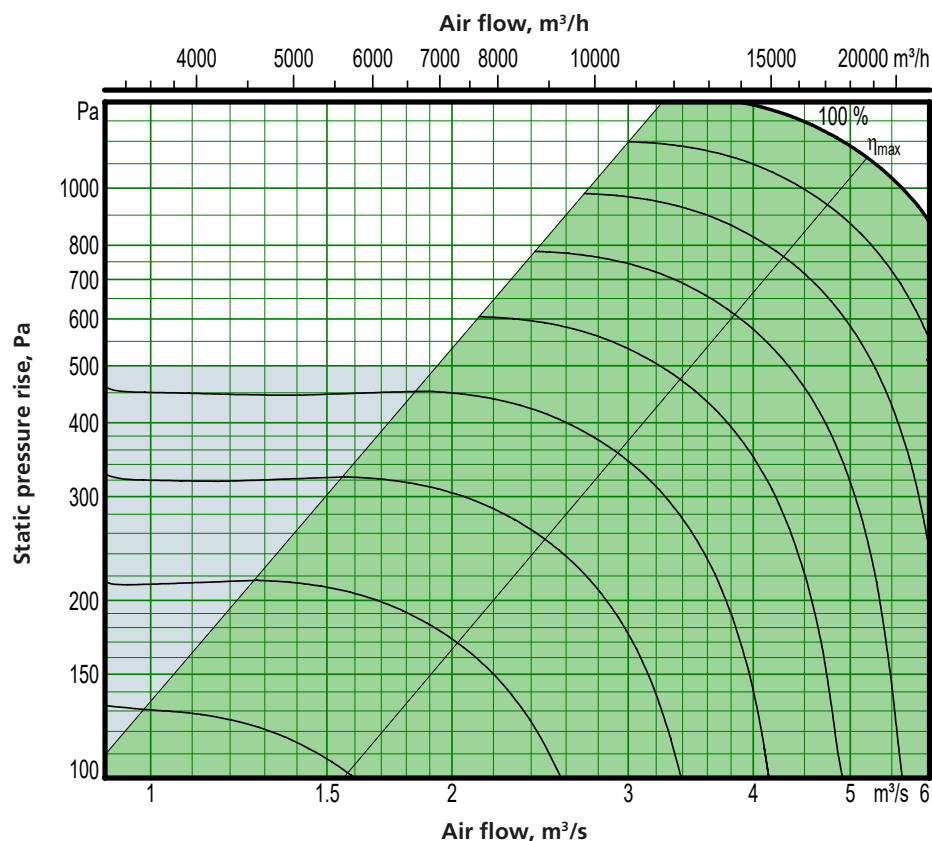

Motor shaft power: 10 kW (capacity variant 2)

- Recommended working range for sizing.
- If pressure regulation is used, the air flow can be regulated to zero.
- However this presupposes a certain static pressure drop in the ducting (approx. 50 Pa).

Min. and max. airflows

The flows specified refer to those that can be preset in the hand-held terminal. The practical flow limits are determined by the external pressure drop.

Size	Min. airflow (on airflow regulation)		Max. airflow	
	m³/h	m³/s	m³/h	m³/s
050	2700	0.75	18000	5.00

Exact sizing can be carried out in the AHU Design air handling unit selection program

Sizing, installation, dimensions and weights

GOLD RX, rotary heat exchanger, size 050/060

Size 060 (Extract air fan size 050 can be selected, see the previous page)

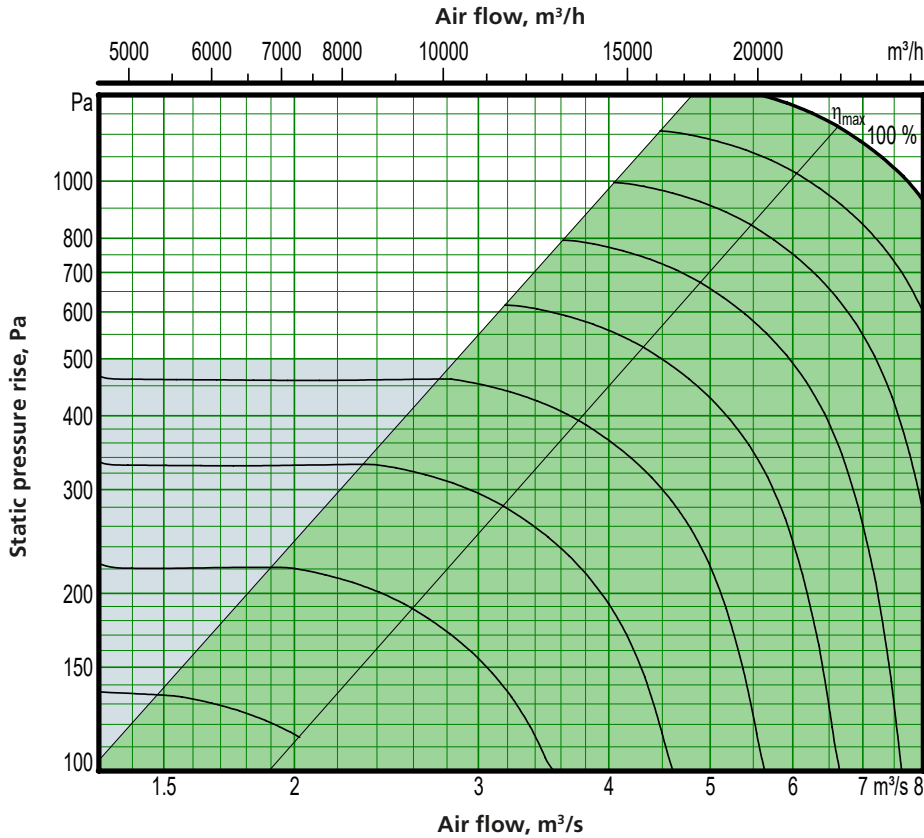

Motor shaft power: 2 x 6.5 kW (capacity variant 2)

- Recommended working range for sizing.
- If pressure regulation is used, the air flow can be regulated to zero.
- However this presupposes a certain static pressure drop in the ducting (approx. 50 Pa).

Min. and max. airflows

The flows specified refer to those that can be preset in the hand-held terminal. The practical flow limits are determined by the external pressure drop.

Size	Min. airflow (on airflow regulation)		Max. airflow	
	m ³ /h	m ³ /s	m ³ /h	m ³ /s
060	3600	1.00	23400	6.50

Exact sizing can be carried out in the AHU Design air handling unit selection program

Sizing, installation, dimensions and weights

GOLD RX, rotary heat exchanger, size 050/060

Delivery and transport within the site

The GOLD RX 050/060 can be supplied as one single unit, or in a number of different combinations of unit sections from the factory, see the section: Description of the Air Handling Unit/Delivery Configuration RX/PX/CX, sizes 011-080.

The unit sections are joined together/split by means of bolts. The electrical and control cables between the unit sections have quick-fit connectors.

The air handling unit/unit sections is/are delivered on wooden beams.

Duct connection options

A: Specify right-hand or left-hand version when ordering. If the air handling unit is supplied with all the end connection panels, the version can be changed at the building site using the hand-held terminal. **Note:** Supply and extract air fans can be selected in different sizes/capacity variants, which must be taken into account.

B: The arrangement of the functional sections can be vertically reversed. To be specified when placing an order, see the illustration to the right.

C: Specify upper fan outlet for upward air discharge when placing orders (not for outdoor units).

D: Specify whether the unit shall have an air intake from above for outdoor air or extract air when placing orders (Does not apply to units installed outdoors). N.B.! Duct connection size: 2,000 x 600 mm.

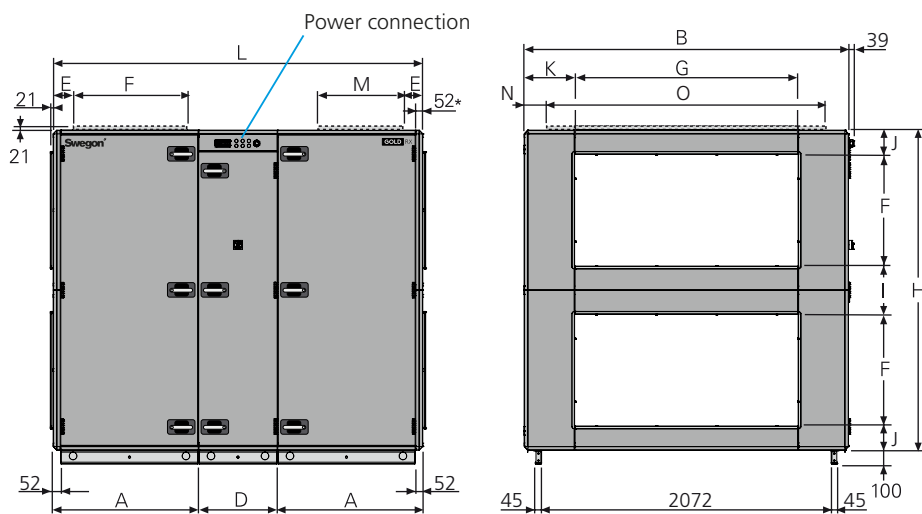
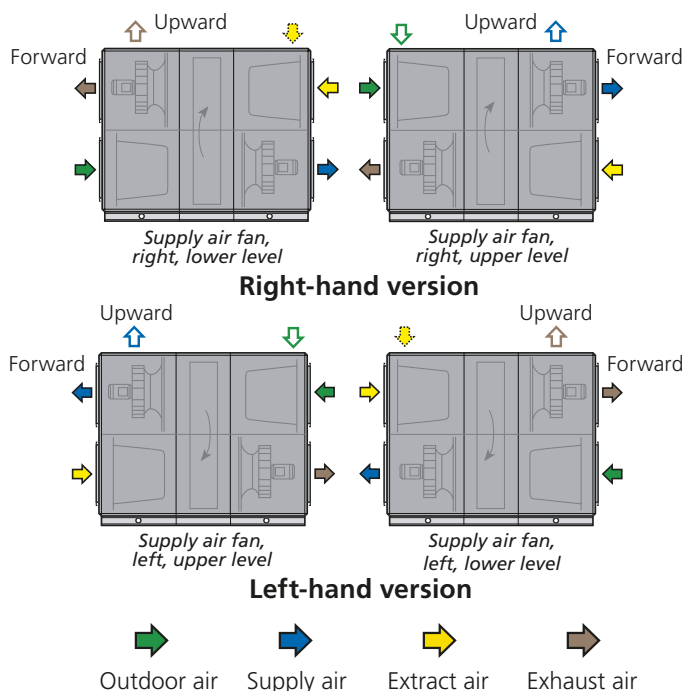

* The air handling unit is supplied without end connection panel if a duct accessory housed in an insulated casing will be connected. The AHU can also be supplied with full face end connection panel (accessory).

Size	A	B	D	E	F	G	H	I	J	K	L	M	N	O	Weight, kg
050/060	1038,5	2318	565	145	800	1600	2288	344	172	359	2642	600	159	2000	1298-1752

Division into sections for transport

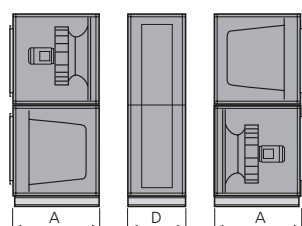

The unit can be divided into three sections at the building site.

Dimensions: See A and D in the table above.

Weight: A = 444-630 kg, D = 410-492 kg.

Clear space for inspection

A clear space of 1,100 mm should be provided in front of the unit.

Rated data per fan

Size 050: Motor shaft power: 6.5 kW alt. 10 kW, motor control system: 3 x 400 V, 50 Hz
 Size 060: Motor shaft power: 2 x 4.0 kW alt. 2 x 6.5 kW, motor control system, 3 x 400 V, 50 Hz

Electrical connection

See table Electrical data at the end of this section.

Sizing, installation, dimensions and weights

GOLD RX, rotary heat exchanger, size 070/080

Size 070 (Extract air fan size 080 can be selected, see the next page)

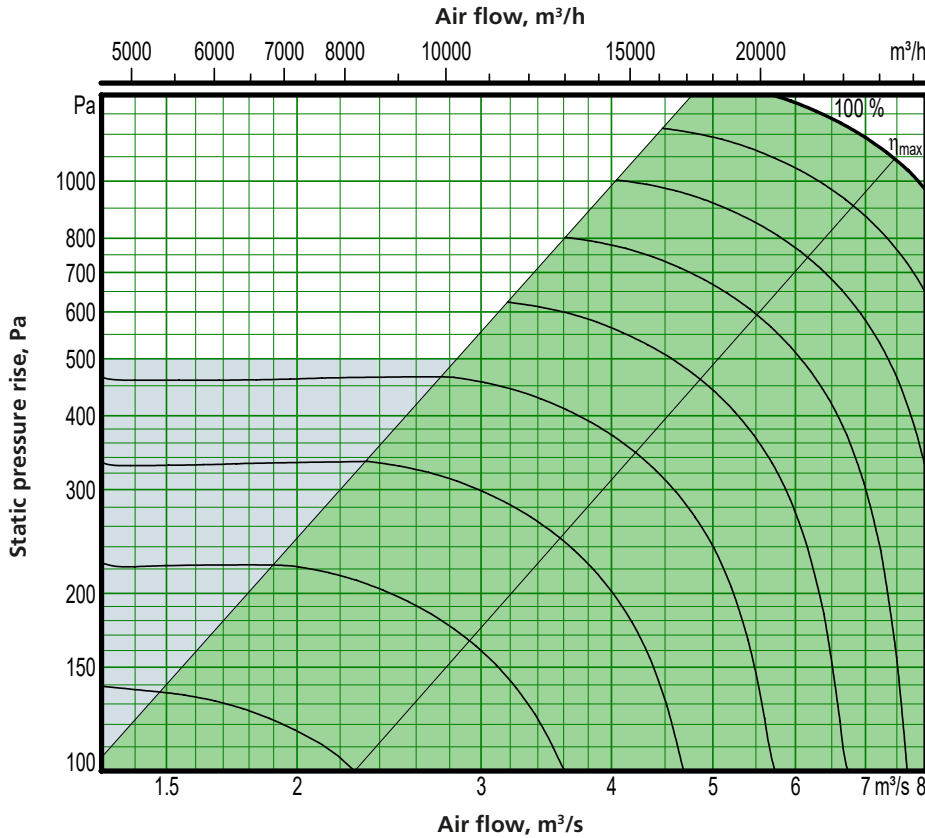

Motor shaft power: 2 x 6.5 kW (capacity variant 2)

- Recommended working range for sizing.
- If pressure regulation is used, the air flow can be regulated to zero.
- However this presupposes a certain static pressure drop in the ducting (approx. 50 Pa).

Min. and max. airflows

The flows specified refer to those that can be preset in the hand-held terminal. The practical flow limits are determined by the external pressure drop.

Size	Min. airflow (on airflow regulation)		Max. airflow	
	m³/h	m³/s	m³/h	m³/s
070	3600	1.00	27000	7.50

Exact sizing can be carried out in the AHU Design air handling unit selection program

Sizing, installation, dimensions and weights

GOLD RX, rotary heat exchanger, size 070/080

Size 080 (Extract air fan size 070 can be selected, see the previous page)

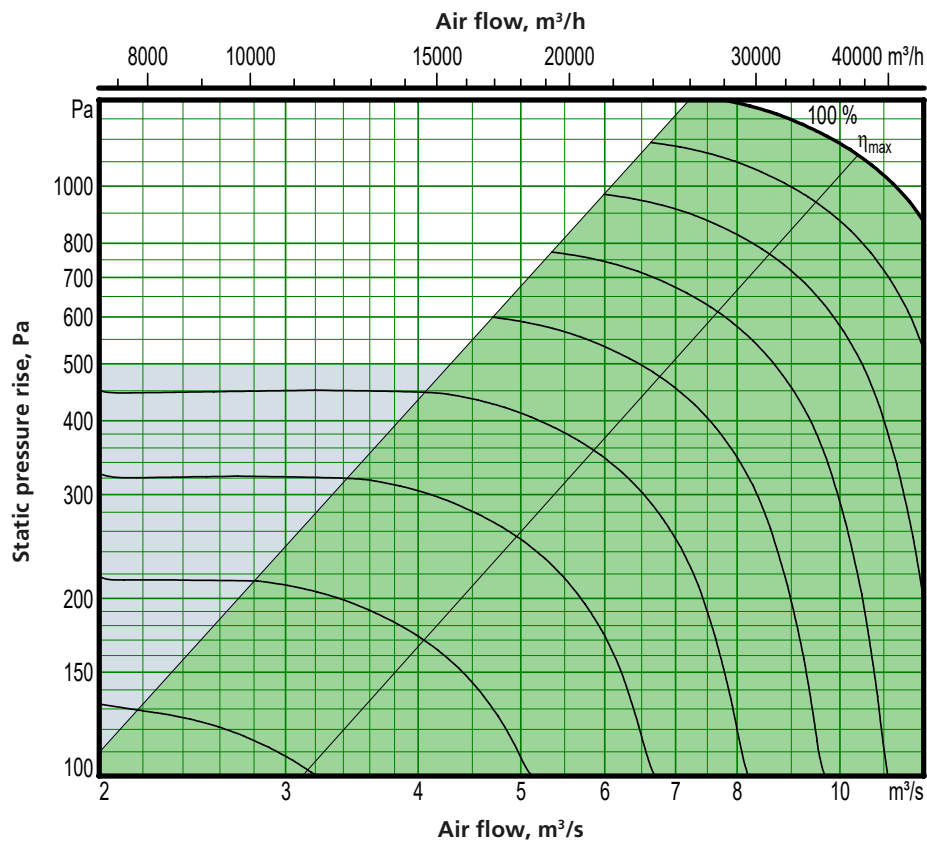

Motor shaft power: 2 x 10 kW (capacity variant 2)

- Recommended working range for sizing.
- If pressure regulation is used, the air flow can be regulated to zero.
- However this presupposes a certain static pressure drop in the ducting (approx. 50 Pa).

Min. and max. airflows

The flows specified refer to those that can be preset in the hand-held terminal. The practical flow limits are determined by the external pressure drop.

Size	Min. airflow (on airflow regulation)		Max. airflow	
	m ³ /h	m ³ /s	m ³ /h	m ³ /s
080	5400	1.50	34200	9.50

Exact sizing can be carried out in the AHU Design air handling unit selection program

Sizing, installation, dimensions and weights

GOLD RX, rotary heat exchanger, size 070/080

Delivery and transport within the site

The GOLD RX 070/080 is supplied in two units, or in a number of different combinations of unit sections from the factory, see the section: Description of the Air Handling Unit/Delivery Configuration RX/PX/CX, sizes 011-080.

The unit sections are jointed together/split by means of bolts. The electrical and control cables between the unit sections have quick-fit connectors

Duct connection options

A: Specify right-hand or left-hand version when ordering. If the air handling unit is supplied with all the end connection panels, the version can be changed at the building site using the hand-held terminal. **Note:** Supply and extract air fans can be selected in different sizes/capacity variants, which must be taken into account.

B: The arrangement of the functional sections can be vertically reversed. To be specified when placing an order, see the illustration to the right.

C: Specify upper fan outlet for upward air discharge when placing orders (not for outdoor units).

D: Specify whether the unit shall have an air intake from above for outdoor air or extract air when placing orders (Does not apply to units installed outdoors). N.B.! Duct connection size: 2,400 x 750 mm.

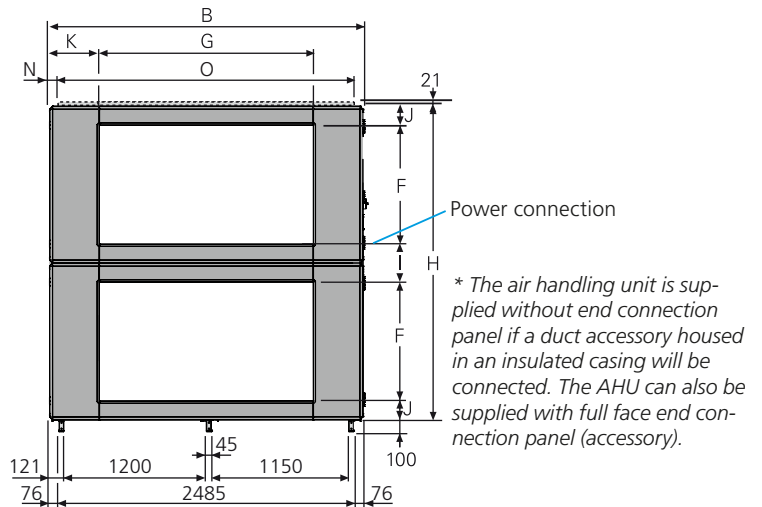
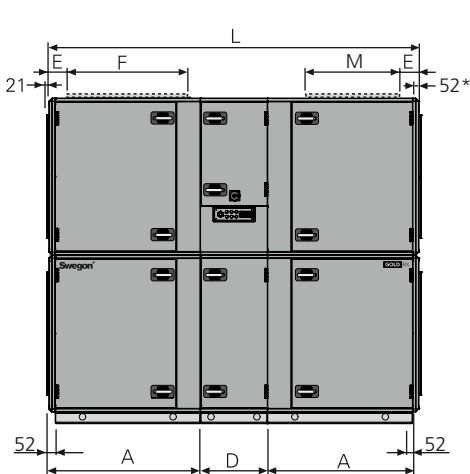
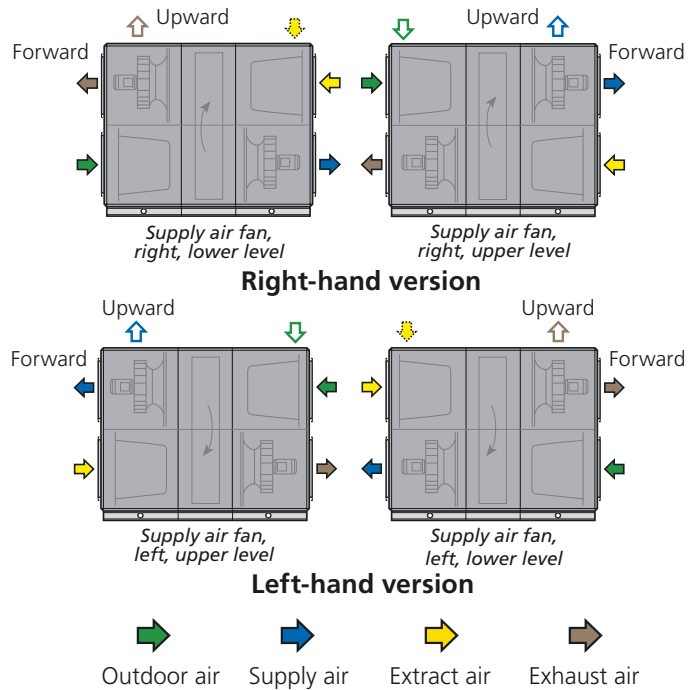

Size	A	B	D	E	F	G	H	I	J	K	L	M	N	O	Weight, kg
070/080	1273,5	2637	565	162	1000	1800	2640	320	160	418,5	3112	750	118,5	2400	2218-2649

Division into sections for transport

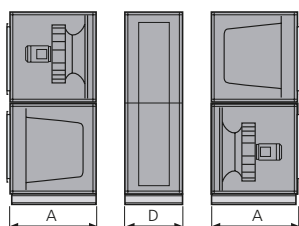

The unit can be divided into three sections at the building site.

Dimensions: See A and D in the table above.

Weight: A = 786-956 kg, D = 646-737 kg.

Clear space for inspection

A clear space of 1,100 mm should be provided in front of the unit.

Rated data per fan

Size 070: Motor shaft power: 2 x 4.0 kW alt. 2 x 6.5 kW, motor control system, 3 x 400 V, 50 Hz
 Size 080: Motor shaft power: 2 x 6.5 kW alt. 2 x 10 kW, motor control system: 3 x 400 V, 50 Hz

Electrical connection

See table Electrical data at the end of this section.

Sizing, installation, dimensions and weights

GOLD RX, rotary heat exchanger, size 100

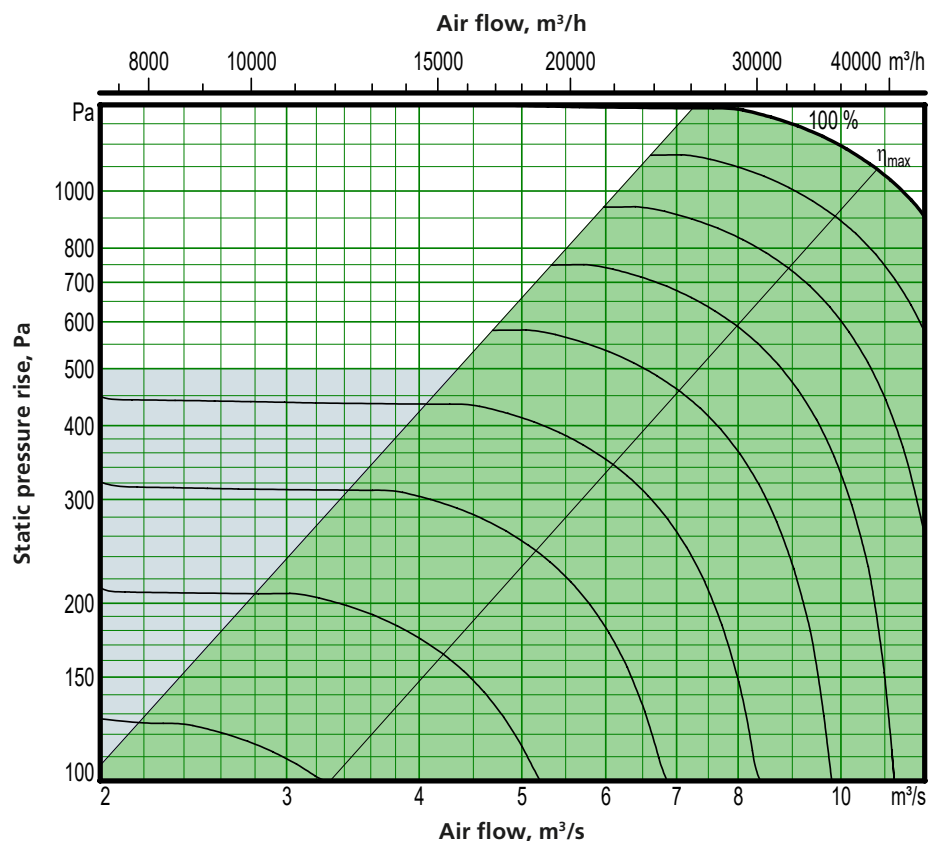

Motor shaft power: 2 x 10 kW (capacity variant 2)

- Recommended working range for sizing.
- If pressure regulation is used, the air flow can be regulated to zero.
- However this presupposes a certain static pressure drop in the ducting (approx. 50 Pa).

Min. and max. air flows

The flows specified refer to those that can be preset in the hand-held terminal. The practical flow limits are determined by the external pressure drop.

Size	Min. airflow (on airflow regulation)		Max. airflow	
	m³/h	m³/s	m³/h	m³/s
100	5400	1.50	39600	11.0

Exact sizing can be carried out in the AHU Design air handling unit selection program

Sizing, installation, dimensions and weights

GOLD RX, rotary heat exchanger, size 100

Delivery and transport within the site

The GOLD RX 100 is supplied in five separate sections: Two fan sections, two filter sections and one heat exchanger section. The heat exchanger section can also be supplied split into two casing sections and rotor, in which case the rotor is supplied tilted in a transport cradle (transport height = 2,930 mm, minimum transport width = 2,350 mm). After the heat exchanger section has been assembled, if required, the five sections must be installed at the building site.

The five sections are joined together by bolts and the electrical and control cabling between the parts have quick-fit connectors.

Duct connection options

A: Specify right-hand or left-hand version when ordering. If the air handling unit is supplied with all the end connection panels, the version can be changed at the building site using the hand-held terminal. **Note:** Supply and extract air fans can be selected in different capacity variants, which must be taken into account.

B: The arrangement of the functional sections can be vertically reversed. To be specified when placing an order, see the illustration to the right.

C: Specify upper fan outlet for upward air discharge when placing orders (not for outdoor units). N.B.! Duct connection size: 2,500 x 800 mm.

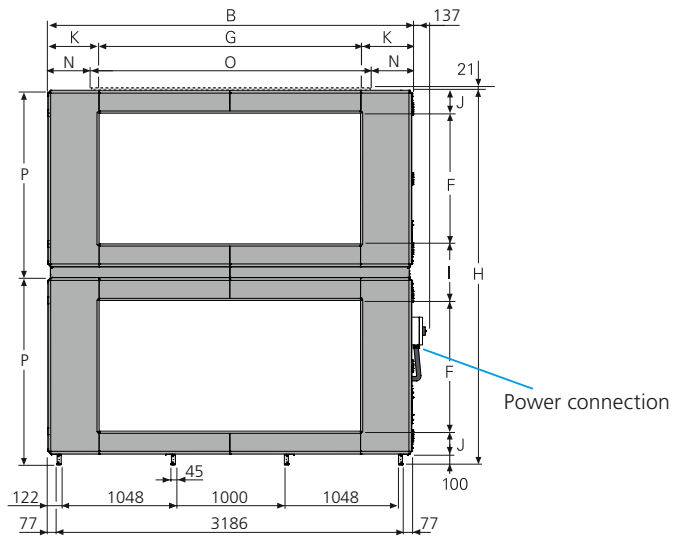
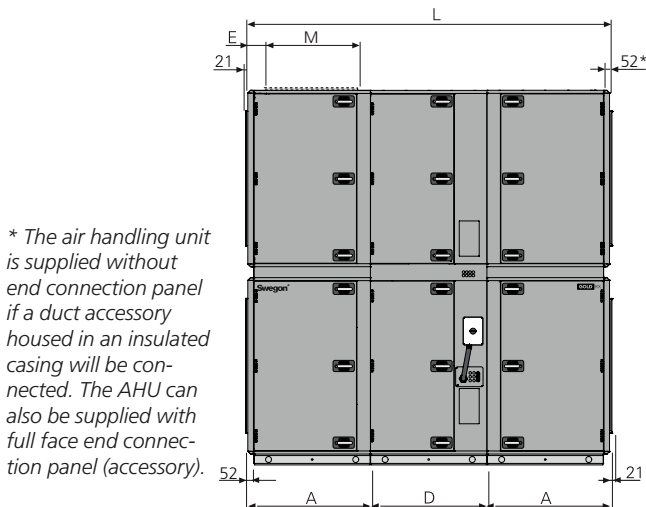
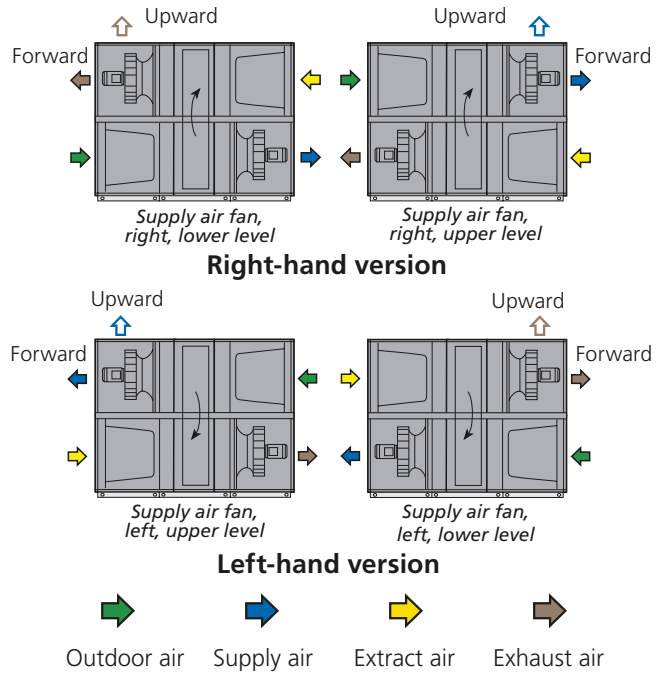

Size	A	B	D	E	F	G	H	I	J	K	L	M	N	O	P	Weight, kg
100	1122	3340	1070	187	1200	2400	3440	520	210	470	3314	800	420	2500	1720	3324-3910

Transport, dimensions and weights

Filter and fan sections

See dimensions A and P in the table above.

Weight: fan section = 644-720 kg, filter section = 402-540 kg.

Heat exchanger section, mounted

See dimensions D and H in the table above.

Weight: heat exchanger section = 1232-1390 kg.

Heat exchanger section, supplied in two casing sections + rotor

See transport dimensions in the Delivery and at-site transport section above.

Weight: casing lower section = 513 kg, casing upper section = 300 kg, rotor = 428 kg, transport cradle = 190 kg

Clear space for inspection

A clear space of 1,000 mm should be provided in front of the unit.

Rated data per fan

Motor shaft power: 2 x 6.5 kW alt. 2 x 10 kW, motor control system: 3 x 400 V, 50 Hz

Electrical connection

See table Electrical data at the end of this section.

Sizing, installation, dimensions and weights

GOLD RX, rotary heat exchanger, size 120

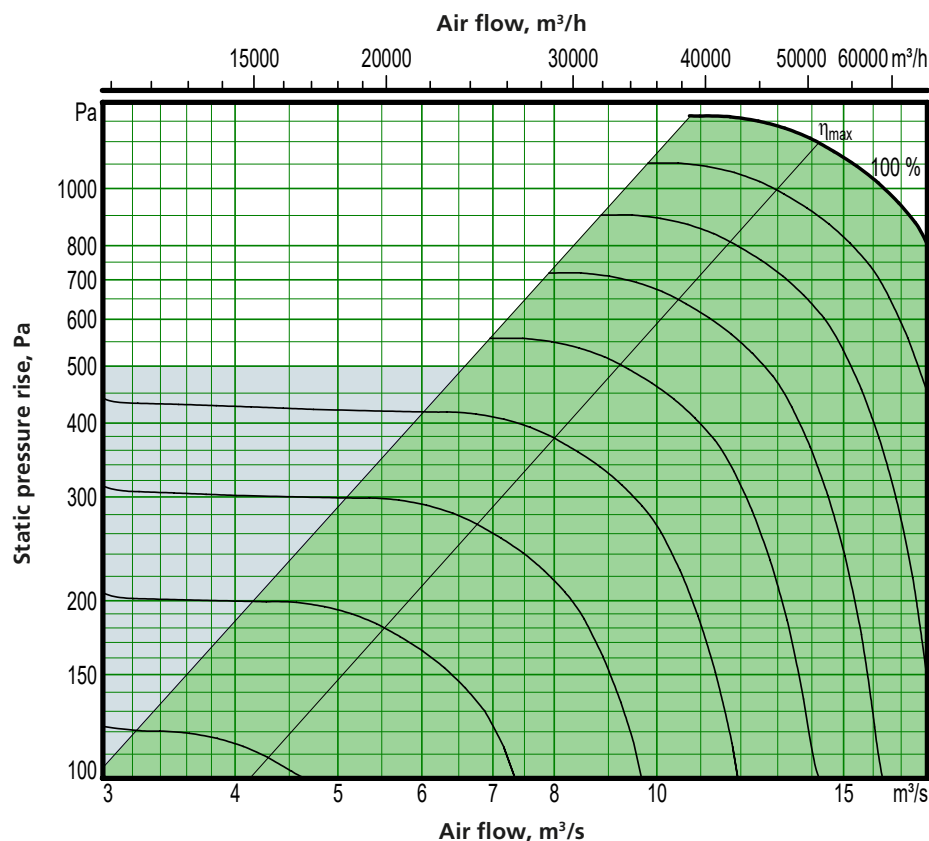

Motor shaft power: 3 x 10 kW (capacity variant 2)

- Recommended working range for sizing.
- If pressure regulation is used, the air flow can be regulated to zero.
- However this presupposes a certain static pressure drop in the ducting (approx. 50 Pa).

Min. and max. air flows

The flows specified refer to those that can be preset in the hand-held terminal. The practical flow limits are determined by the external pressure drop.

Size	Min. airflow (on airflow regulation)		Max. airflow	
	m ³ /h	m ³ /s	m ³ /h	m ³ /s
120	9000	2.50	50400	14.0

Exact sizing can be carried out in the AHU Design air handling unit selection program

Sizing, installation, dimensions and weights

GOLD RX, rotary heat exchanger, size 120

Delivery and transport within the site

The GOLD RX 120 is supplied in five separate sections: Two fan sections, two filter sections and one heat exchanger section. The heat exchanger section can also be supplied split into two casing sections and rotor, in which case the rotor is supplied tilted in a transport cradle (transport height = 2,930 mm, minimum transport width = 2,350 mm). After the heat exchanger section has been assembled, if required, the five sections must be installed at the building site.

The five sections are joined together by bolts and the electrical and control cabling between the parts have quick-fit connectors.

Duct connection options

A: Specify right-hand or left-hand version when ordering. If the air handling unit is supplied with all the end connection panels, the version can be changed at the building site using the hand-held terminal. **Note:** Supply and extract air fans can be selected in different capacity variants, which must be taken into account.

B: The arrangement of the functional sections can be vertically reversed. To be specified when placing an order, see the illustration to the right.

C: Specify upper fan outlet for upward air discharge when placing orders (not for outdoor units). N.B.! Duct connection size: 2,500 x 800 mm.

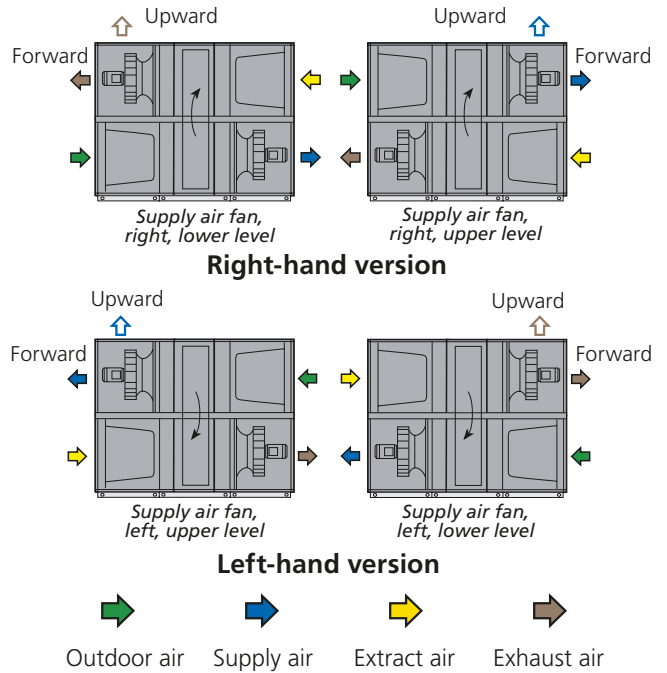

* The air handling unit is supplied without end connection panel if a duct accessory housed in an insulated casing will be connected. The AHU can also be supplied with full face end connection panel (accessory).

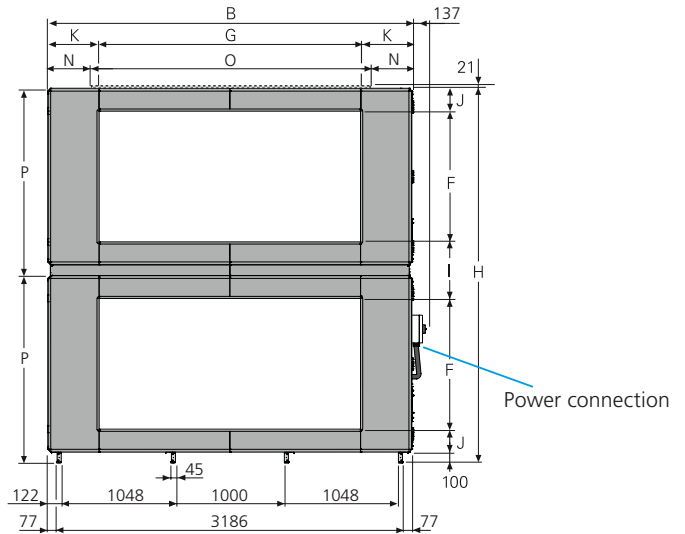
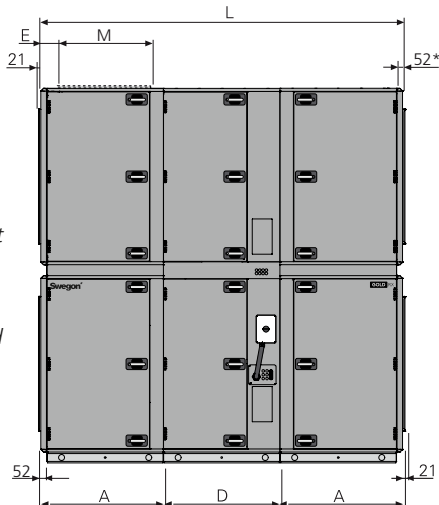

Size	A	B	D	E	F	G	H	I	J	K	L	M	N	O	P	Weight, kg
120	1122	3340	1070	187	1200	2400	3440	520	210	470	3314	800	420	2500	1720	3524-4128

Transport, dimensions and weights

Filter and fan sections

See dimensions A and P in the table above.

Weight: fan section = 744-829 kg, filter section = 402-540 kg.

Heat exchanger section, mounted

See dimensions D and H in the table above.

Weight: heat exchanger section = 1232-1390 kg.

Heat exchanger section, supplied in two casing sections + rotor

See transport dimensions in the Delivery and at-site transport section above.

Weight: casing lower section = 513 kg, casing upper section = 300 kg, rotor = 428 kg, transport cradle = 190 kg

Clear space for inspection

A clear space of 1,000 mm should be provided in front of the unit.

Rated data per fan

Motor shaft power: 3 x 6.5 kW alt. 3 x 10 kW, motor control system: 3 x 400 V, 50 Hz

Electrical connection

See table Electrical data at the end of this section.

Sizing, installation, dimensions and weights

GOLD RX, rotary heat exchanger, size 014 - 040

Electrical data

Shows the fuse size for different combinations of fan sizes and capacity variants. Fan A or B can be a supply air fan or an extract air fan or vice versa. It is the combination of fan A and B that determines the fuse size.

Electrical connection is 3-phase, 5-wire, 400 V -10/+15%, 50 Hz.

GOLD RX, size	Fan A, size/capacity variant	Fan B, size/capacity variant	Fuse protection (A)
014/020	014-1 (1,6 kW)	014-1 (1,6 kW)	10
	014-1 (1,6 kW)	014-2 (2,4 kW)	10
	014-1 (1,6 kW)	020-1 (2,4 kW)	10
	014-1 (1,6 kW)	020-2 (3,4 kW)	16
	014-2 (2,4 kW)	014-2 (2,4 kW)	10
	014-2 (2,4 kW)	020-1 (2,4 kW)	10
	014-2 (2,4 kW)	020-2 (3,4 kW)	16
	020-1 (2,4 kW)	020-1 (2,4 kW)	10
	020-1 (2,4 kW)	020-2 (3,4 kW)	16
	020-2 (3,4 kW)	020-2 (3,4 kW)	16
025/030	025-1 (2,4 kW)	025-1 (2,4 kW)	10
	025-1 (2,4 kW)	025-2 (3,4 kW)	16
	025-1 (2,4 kW)	030-1 (4,0 kW)	16
	025-1 (2,4 kW)	030-2 (5,0 kW)	16
	025-2 (3,4 kW)	025-2 (3,4 kW)	16
	025-2 (3,4 kW)	030-1 (4,0 kW)	16
	025-2 (3,4 kW)	030-2 (5,0 kW)	20
	030-1 (4,0 kW)	030-1 (4,0 kW)	20
	030-1 (4,0 kW)	030-2 (5,0 kW)	20
	030-2 (5,0 kW)	030-2 (5,0 kW)	20
035/040	35-1 (4,0 kW)	35-1 (4,0 kW)	20
	35-1 (4,0 kW)	35-2 (5,0 kW)	20
	35-1 (4,0 kW)	40-1 (6,5 kW)	25
	35-1 (4,0 kW)	40-2 (10 kW)	25
	35-2 (5,0 kW)	35-2 (5,0 kW)	20
	35-2 (5,0 kW)	40-1 (6,5 kW)	25
	35-2 (5,0 kW)	40-2 (10 kW)	32
	40-1 (6,5 kW)	40-1 (6,5 kW)	25
	40-1 (6,5 kW)	40-2 (10 kW)	32
	40-2 (10 kW)	40-2 (10 kW)	40

Sizing, installation, dimensions and weights

GOLD RX, rotary heat exchanger, size 050 - 120

Electrical data

Shows the fuse size for different combinations of fan sizes and capacity variants. Fan A or B can be a supply air fan or an extract air fan or vice versa. It is the combination of fan A and B that determines the fuse size.

Electrical connection is 3-phase, 5-wire, 400 V -10/+15%, 50 Hz.

GOLD RX, size	Fan A, size/capacity variant	Fan B, size/capacity variant	Fuse protection (A)
050/060	50-1 (6,5 kW)	50-1 (6,5 kW)	25
	50-1 (6,5 kW)	50-2 (10 kW)	32
	50-1 (6,5 kW)	60-1 (2 x 4,0 kW)	32
	50-1 (6,5 kW)	60-2 (2 x 6,5 kW)	40
	50-2 (10 kW)	50-2 (10 kW)	40
	50-2 (10 kW)	60-1 (2 x 4,0 kW)	40
	50-2 (10 kW)	60-2 (2 x 6,5 kW)	50
	60-1 (2 x 4,0 kW)	60-1 (2 x 4,0 kW)	32
	60-1 (2 x 4,0 kW)	60-2 (2 x 6,5 kW)	40
	60-2 (2 x 6,5 kW)	60-2 (2 x 6,5 kW)	50
070/080	70-1 (2 x 4,0 kW)	70-1 (2 x 4,0 kW)	32
	70-1 (2 x 4,0 kW)	70-2 (2 x 6,5 kW)	40
	70-1 (2 x 4,0 kW)	80-1 (2 x 6,5 kW)	40
	70-1 (2 x 4,0 kW)	80-2 (2 x 10 kW)	50
	70-2 (2 x 6,5 kW)	70-2 (2 x 6,5 kW)	50
	70-2 (2 x 6,5 kW)	80-1 (2 x 6,5 kW)	50
	70-2 (2 x 6,5 kW)	80-2 (2 x 10 kW)	63
	80-1 (2 x 6,5 kW)	80-1 (2 x 6,5 kW)	50
	80-1 (2 x 6,5 kW)	80-2 (2 x 10 kW)	63
	80-2 (2 x 10 kW)	80-2 (2 x 10 kW)	80
100	100-1 (2 x 6,5 kW)	100-1 (2 x 6,5 kW)	50
	100-1 (2 x 6,5 kW)	100-2 (2 x 10 kW)	63
	100-2 (2 x 10 kW)	100-2 (2 x 10 kW)	80
120	120-1 (3 x 6,5 kW)	120-1 (3 x 6,5 kW)	80
	120-1 (3 x 6,5 kW)	120-2 (3 x 10 kW)	100
	120-2 (3 x 10 kW)	120-2 (3 x 10 kW)	125