

GLOBAL RX TOP

Ventilation unit with rotary heat exchanger - TAC6



Ventilation unit with rotary heat exchanger, for commercial premises. Suitable both for new construction and when renovating existing buildings.

Max. airflow 3050 m³/h (848 l/s).

Temperature efficiency: up to 85%.

Energy-efficient and quiet fans with fan impeller made of composite material or aluminium.

For installation indoors in building service rooms, storage areas, etc.

Heat exchangers with temperature efficiency class Standard or Premium are available.

Top quality control system with touch screen.

Units up to GLOBAL RX 12 have external dimensions that allow passage through a door.

HIGHLY EFFICIENT VENTILATION UNIT WITH ENERGY RECOVERY

Each project has unique parameters and must satisfy different requirements. That is why Swegon offers a wide selection of air handling units and always has a solution to match your needs.

The GLOBAL series includes fans equipped with high performance direct-current motors (TAC technology) that meet the most stringent requirements regarding energy performance, such as the ErP2018. The latest control system (Total Airflow Control) is at the technical forefront, thanks both to its internal functionality and its open communication (Modbus, TCP/IP, BACnet, KNX).

PLUG-AND-PLAY UNIT

The GLOBAL ventilation units are supplied as plug-and-play units. The basic functions are factory programmed and the accessories are installed, connected and configured prior to delivery from the factory. When the display has been connected, you only need to turn on the power to the unit and, if necessary, alter the preconfigured parameter values.

ACCESSIBILITY FOR MAINTENANCE

The unit has large inspection doors that make the maintenance work easier. All components, including bypass dampers and actuators, are easily accessible and can be cleaned with mild detergent.

ROTARY HEAT EXCHANGER

The rotary heat exchanger has a high temperature efficiency, above 80%, and is made of salt-resistant aluminium. It satisfies the requirements in standard EN 308 and is Eurovent certified.

FANS

The direct-driven EC fans have fan impellers made of composite material as standard. Aluminium fan impellers are available as an option. The benefits of composite fan impellers are their low weight and more aerodynamic form, which results in low noise levels and provides the fan with lower specific fan power (SFP). The impellers are made of bio-polyamides that are fully recyclable. The fan motor is of the EC type (electronically commutated) with an integrated EC control unit. The motor conforms to enclosure class IP 54. The powerful EC fans ensure that sufficient external pressure is available, even at higher airflows. The efficiency conforms to the requirements in ErP2018. The fans are dynamically balanced in accordance with ISO 1940, class G6.3.

FREE COOLING

The reduction in the speed of the rotary heat exchanger utilises the cooler outdoor air to cool the premises if necessary. This makes the free cooling function possible and is regulated automatically based on the indoor and outdoor temperature.

HEATER

The GLOBAL units can be supplied with a factory-fitted, built-in, waterborne or electric post-heater. The heater's output is adjusted in order to maintain a constant temperature.

DAMPERS

The GLOBAL units can be supplied with factory-fitted, motor-driven outdoor air and exhaust air dampers. In units fitted with dampers, the TAC control unit activates a fan start delay when the unit is started up. Spring return actuators are available as optional equipment. For units with a circular connection, the dampers are supplied separately.

AIR FILTERS

The GLOBAL units are supplied with bag filters made of glass fibre. The function of the filter is to keep both the air and the heat exchanger free from contaminants. As standard, the outdoor air filter has filter class ePM1 \geq 70% and the extract air filter has ePM10 \geq 55%. Extract air filters of class ePM1 \geq 70% are not available as an option, as this would have a detrimental impact on energy efficiency. The filters are installed in lockable guide rails to make filter changing and cleaning of the filter section easier. The filter guide rails satisfy the requirements for airflow leakage according to filter class F9/ePM1 \geq 80% (EN 1886). The filter monitoring function is integrated in the TAC control unit's standard configuration.

Pre-filter of class G4/COARSE, installed inside the air handling unit, can be ordered as an optional extra. A pre-filter is used when the outdoor air is heavily contaminated, in order to prevent the fine filters in the GLOBAL unit from clogging up unreasonably quickly. All filters are classified in accordance with both ISO EN 16890 and ISO EN 779, and are Eurovent certified: 08.10.44.

CONTROL UNITS

The integrated control system TAC is connected to HMI TAC-touch, a 4.3" capacitive touch screen. The air handling units can be configured and controlled from the touch screen.

SAT MODBUS for configuration, indication and display as well as controlling the operation of the unit via MODBUS RTU.

SAT KNX for configuration, indication and display as well as controlling the operation of the unit via KNX.

SAT Ethernet for configuration, indication and display as well as controlling the operation of the unit via MODBUS TCP/IP.

BACnet gateway for configuration, indication and display as well as controlling the operation of the unit via BACnet IP.

SAT Wifi for configuration, indication and display as well as controlling the operation of the unit via wireless communication.

CHARACTERISTICS

- EN1886 classification: T3/TB2/F9/L2/D2.
- Eurovent certified heat exchanger with high temperature efficiency.
- Built-in electrical or waterborne post-heater available as an option. Fully integrated control system.
- HMI with intuitive commissioning menu and integrated, context-based assistance.
- EC plenum fans with fan impellers made of composite material for high efficiency and low noise levels. Aluminium fan impellers are available as an option.
- All doors can be hung on hinges on both sides. This makes it easier to access all components, including in installations where space is limited.
- Made of galvanised sheet steel painted in colour RAL7016, with 50 mm mineral wool insulation.
- Robust design with aluminium profiles.
- Designed so that it can be dismantled and reassembled on site.
- Circular duct connections with rubber seal (05/08/10).
- Plug-and-play unit with complete electrical connections. The unit and all the accessories are installed, connected and configured prior to delivery from the factory.
- Filter class ePM1 70% for outdoor air and ePM10 55% for extract air. Class G4 pre-filter for outdoor air intake available as an option.
- Base frame with openings facilitates transport and handling at the installation site.
- The base frame is 125 mm tall and has 48 mm lifting holes.
- Installation and detailed work of high quality; the hinge's closing force and alignment can be adjusted.
- Tried and tested, preconfigured TAC control unit.
- Software for unit selection is available online.
- ERP2018-optimised design.
- Conforms to the requirements in hygiene standard VDI6022.
- Conforms to the requirements in standard ISO EN 16890.
- Conforms to the requirements in standard ISO EN 16798-3.
- Units up to GLOBAL RX TOP 12 have external dimensions that allow passage through a door.

OPTIONAL EXTRAS

- Built-in electric post-heater
- Built-in waterborne post-heater
- External post-heater/cooler
- Motor-driven dampers
- Flexible duct connection : cricular or rectangular (20/30 mm)
- Slip clamp 20 mm



THE CORRECT OPERATING MODE IS IMPORTANT

AIRFLOW OR PRESSURE

Whether the ventilation system is to work with constant pressure, with a constant airflow or be controlled with voltage signal 0-10 V from a control system is dependent on the application and the requirements stipulated by the installation in question. The built-in control system ensures that the operation is always well-balanced.

CONSTANT AIRFLOW

This operating mode is often used in buildings that do not require variable airflows, such as office buildings and commercial properties, schools, daycare centres, sports halls, etc., where the airflow requirement is relatively stable.

DEMAND CONTROL

Alternatively, the airflow can be adjusted automatically according to the ventilation requirements and the wishes of the users with the aid of the 0-10 V signal input, for example with a CO₂ sensor or with the customer's automated building management system or equivalent.

CONSTANT PRESSURE

This operating mode is very well suited to premises where you ideally want to have the potential to control the airflow individually in the various rooms. A pressure sensor ensures that the pressure remains constant, even when the airflow is increased or decreased in accordance with the ventilation requirement in the room.

The airflow remains unchanged in all the other rooms, i.e. the ventilation system works constantly within its optimum operating range. Constant pressure operation requires an external pressure sensor.

THE 3 OPERATING MODES

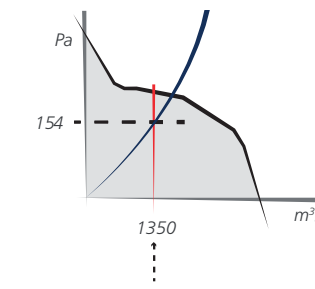

Constant airflow

The airflow is kept constant, regardless of changes in pressure.

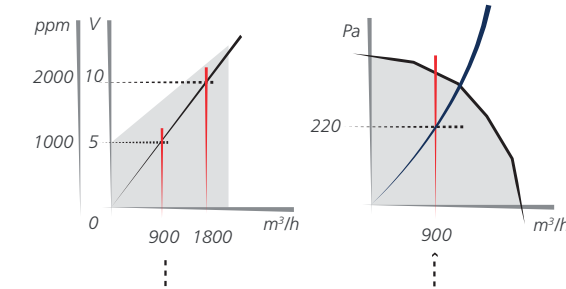

Demand control

The airflow is a linear function of the control voltage. The airflow is regulated with a control voltage of 0-10 V.

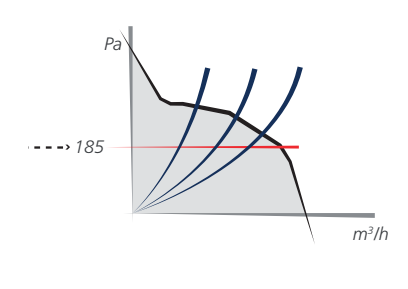

Constant pressure

The pressure is kept constant, regardless of changes in the external pressure. Constant pressure operation requires an external pressure sensor.

CONTROL UNIT ALTERNATIVES

TACTOUCH HMI

HMI with an LCD display and built-in timer control of 6 events per day. All parameters can be set and the unit can be controlled via the touch screen. Commissioning menu, alarm history, operating parameters and error messages are presented in plain text.

4-MODE SELECTOR

With the 4-mode selector, the unit can be set to one of its three configured operating speeds, or be turned off.

SAT MODBUS

Interfaces for configuration, indication and display as well as controlling the operation of the unit via MODBUS RTU.

SAT ETHERNET

Interfaces for configuration, indication and display as well as controlling the operation of the unit via MODBUS TCP/IP.

BACNET GATEWAY

For communication with the ventilation unit via BACnet TCP/IP protocol. The interface can handle up to four units. BACnet gateway requires the installation of the SAT Ethernet interface.

SAT WIFI

Wifi interface that, together with the TAC control unit, facilitates wireless communication with the air handling unit. The Wifi interface is normally used when you want to control the unit from a mobile phone.

SAT KNX

Interfaces for configuration, indication and display as well as controlling the operation of the unit via KNX.

SAT IO

SAT IO is a satellite circuit, intended to be mounted on the main control card. It is used to expand the number of inputs and outputs.

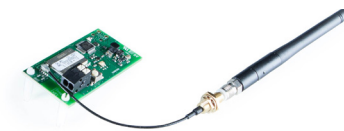

GLOBAL RX TOP – GENERAL

CIRCULAR DUCT CONNECTIONS

The duct connections for sizes 05, 08 and 10 are circular and are fitted with a rubber seal. The units can be combined with motor-driven dampers.

RECTANGULAR DUCT CONNECTIONS

The standard duct connections (15 mm) for size 12 and above are rectangular. For units with rectangular duct connections, there are several options: rectangular/circular adapter, 20 mm slip-clamp connections or 30 mm sleeve connections (METU). The units can be combined with motor-driven dampers and flexible duct connections.

CASING

The GLOBAL unit's casing has a frame made of aluminium profiles, held together by plastic corner pieces. The casing panels are a 50 mm thick sandwich construction made of sheet steel with intervening mineral wool insulation. The outer sheet steel is painted in colour RAL7016, while the inner sheet steel is galvanised. The doors are hung from four hinges supplied with handles, two on either side. The doors can therefore be opened in both directions.

Casing data according to EN1886:

Air leakage class: L2 (R)

Thermal bridges: TB2

Thermal transmittance: T3 (Optimised insulation as optional extra)

Mechanical strength: D2 (M)

Airflow leakage filter: F9/ePM1 ≥ 80 %

EC FANS WITH FAN IMPELLERS MADE OF COMPOSITE MATERIAL

The EC fans have fan impellers made of composite material as standard, which provides the fan with lower specific fan power (SFP). The benefits of composite fan impellers are their low weight and more aerodynamic form. Aluminium fan impellers are available as an option.

BASE FRAME

A base frame is pre-installed under all GLOBAL units. The base frame is self-supporting. The frame is 125 mm high and is fitted both with 48 mm lifting holes for lifting with a crane as well as with notches for forklift truck forks.

ROTARY HEAT EXCHANGER

The rotary heat exchanger has a thermal efficiency of up to 85%. The speed of the rotor is adjusted steplessly to satisfy heating and cooling requirements. The rotary condensing heat exchangers are available in two versions: a premium version for high heat recovery (RX+) and a standard version for a lower pressure drop and a lower price (RX). The purging sector, mounted on both versions, prevents extract air and impurities being transferred to the supply air. The heat exchanger satisfies the requirements in standard EN 308 and is Eurovent certified.

BUILT-IN WATERBORNE HEATER

The unit can be equipped with a built-in waterborne air heater. The heater is placed downstream of the heat exchanger. The waterborne heater has built-in water connections and is supplied with flexible connections made of stainless steel in order to connect to the existing water system outside the unit. The waterborne heater is fitted with a temperature sensor for freeze protection, installed on the surface of the heater. Three-way valve and actuator are supplied with the heater.

BUILT-IN ELECTRIC AIR HEATER

The heater is placed downstream of the heat exchanger. The electric heater has two overheating protection units, one with manual resetting and the other with automatic resetting. When stopping the unit, the electric heater is immediately turned off, but the fans continue to run for 90 seconds to cool the heater.

EXTERNAL AIR HEATER/COOLER

The GLOBAL units can be configured with external heaters/coolers, fitted in an insulated casing. Water-based or directly expanding (DX) heaters/coolers can be used. Its output is adjusted in order to maintain a constant supply air or extract air temperature. The waterborne unit is supplied ready-to-connect, such as a 3-way valve, which is controlled from the TAC control unit. With the TAC control system, GLOBAL units can control any combination of heater/cooler (water or DX) for cooling alone, heating alone or cooling and heating in sequence.

CONTROL UNIT TAC

The control equipment is fully integrated in the GLOBAL units. The control unit monitors and regulates temperatures, airflows and other functions. The control unit is pre-configured with standard values on delivery from the factory. Many built-in functions are included in the system and are easy to activate. The air handling units can be regulated automatically in several different ways, with the aid of the built-in timer control or with the main control system, but also with the aid of e.g. a CO₂ sensor. Manual control is also possible.

HMI

User-friendly 4.3" touch screen. The interface includes a menu that makes commissioning easy and intuitive. The touch screen has a 2-metre long connection cable and a magnetic bracket, which means that it can be attached anywhere on the unit. The set values are stored in the memory, which means they are not lost in the event of a power failure.

EC PLENUM FAN MADE OF COMPOSITE MATERIAL
(ALUMINIUM IS AVAILABLE AS AN OPTION) 1

BAG FILTER FOR OUTDOOR AIR, CLASS F7
(PRE-FILTER CLASS G4 AVAILABLE AS AN OPTIONAL
EXTRA) 2

BUILT-IN CONTROL UNIT 3

HINGES FOR GOOD ACCESSIBILITY 4

BASE FRAME DESIGNED SIMPLE TRANSPORT 5

HIGHLY EFFICIENT ROTARY HEAT EXCHANGER 6

BUILT-IN POST-HEATER (WATERBORNE/ELECTRIC) 7

STEPLESS ROTOR DRIVE UNIT WITH
WELDED BELT 8

BAG FILTER FOR EXTRACT AIR, CLASS M5 9

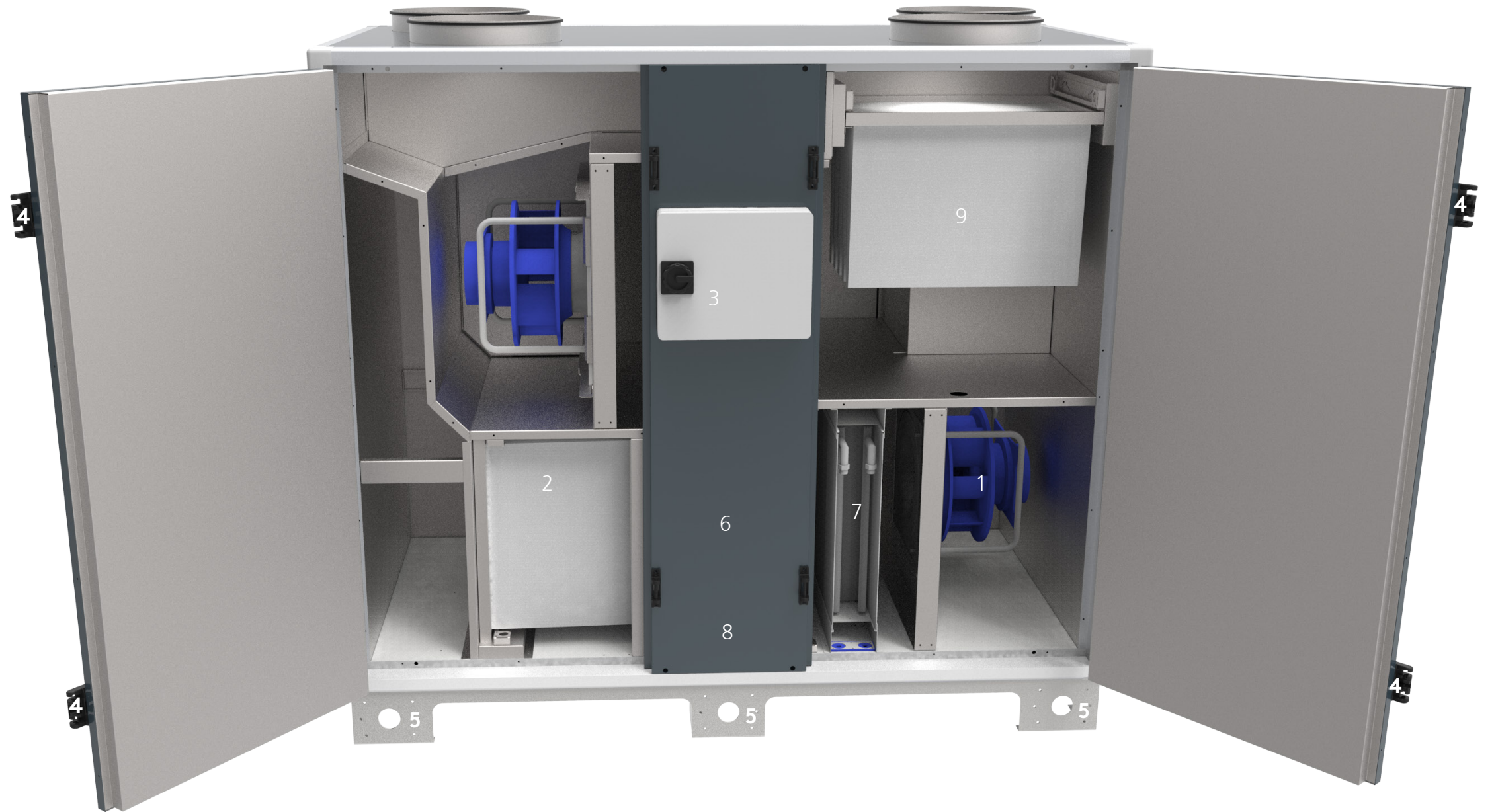

GLOBAL RX+ TOP 05

FAN DIAGRAMS

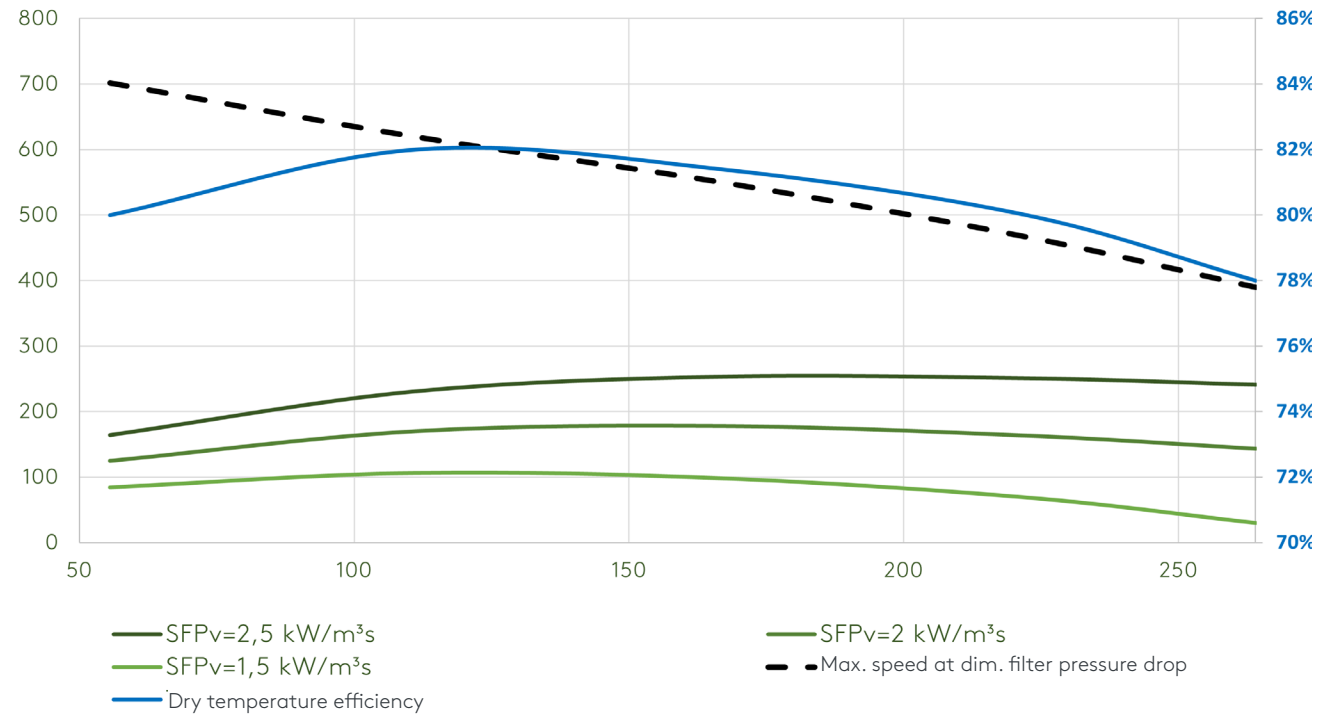

• AIRFLOW	200-950 m³/h
	56-264 l/s
• DIMENSIONS (L x W x H)	1530 x 815 x 1315
• WEIGHT	340 kg
• ELECTRIC POWER SUPPLY	1 x 230 V
• MAX. POWER CONSUMPTION	5.3 A
• RECOMMENDED FUSE PROTECTION	D6A - 10kA - AC3
• FILTER CLASS (BAG FILTER)	F7 (ePM1 70%) / M5 (ePM10 55%)
• STANDARD DUCT CONNECTIONS (15 mm)	Ø 250
• GUIDE DUCT CONNECTIONS (20 mm)	NOT APPLICABLE
• AMBIENT TEMPERATURE	-20 ... +50°C
• EN1886 CLASSIFICATION	T3/TB2/F9/L2/D2

AIRFLOW	Pa ext	SFPv	Speed dim. used/Max, supply air	Speed dim. used/Max, extract air	POWER CONSUMPTION	Dry temperature efficiency	Conditions
m³/h	l/s	kW/m³/s	%	%	kW	%	
200	56	200	2.9	58	56	0.2	80%
400	111	200	2.2	65	65	0.2	82%
600	167	200	2.1	73	73	0.4	81%
800	222	200	2.2	81	82	0.5	80%
950	264	200	2.3	86	88	0.6	78%

1. Calculated values at 200 Pa ext. pressure (150/50 Pa)
 2. All data applies to fans with composite fan impeller and heat exchangers with efficiency class Premium
 3. SFP and absorbed power calculated with clean filter
 4. Speed dim. calculated at dim. filter pressure drop

DIMENSIONS (mm)

GLOBAL RX+ TOP 05

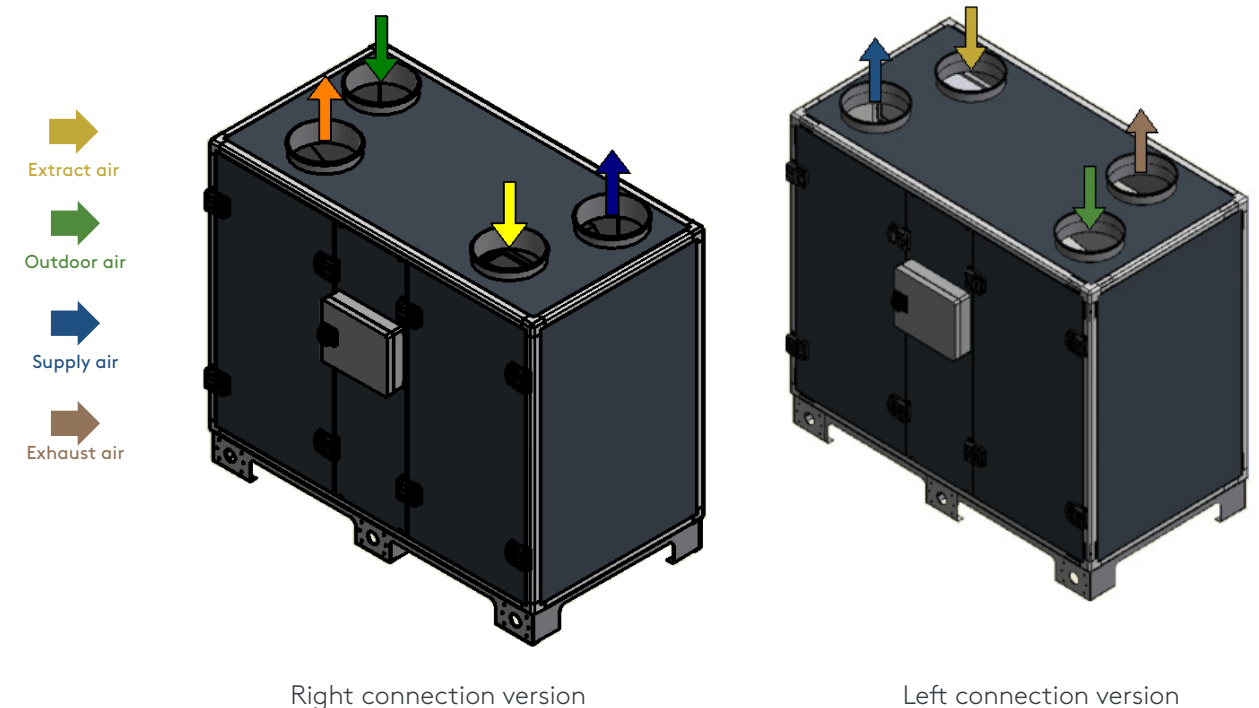
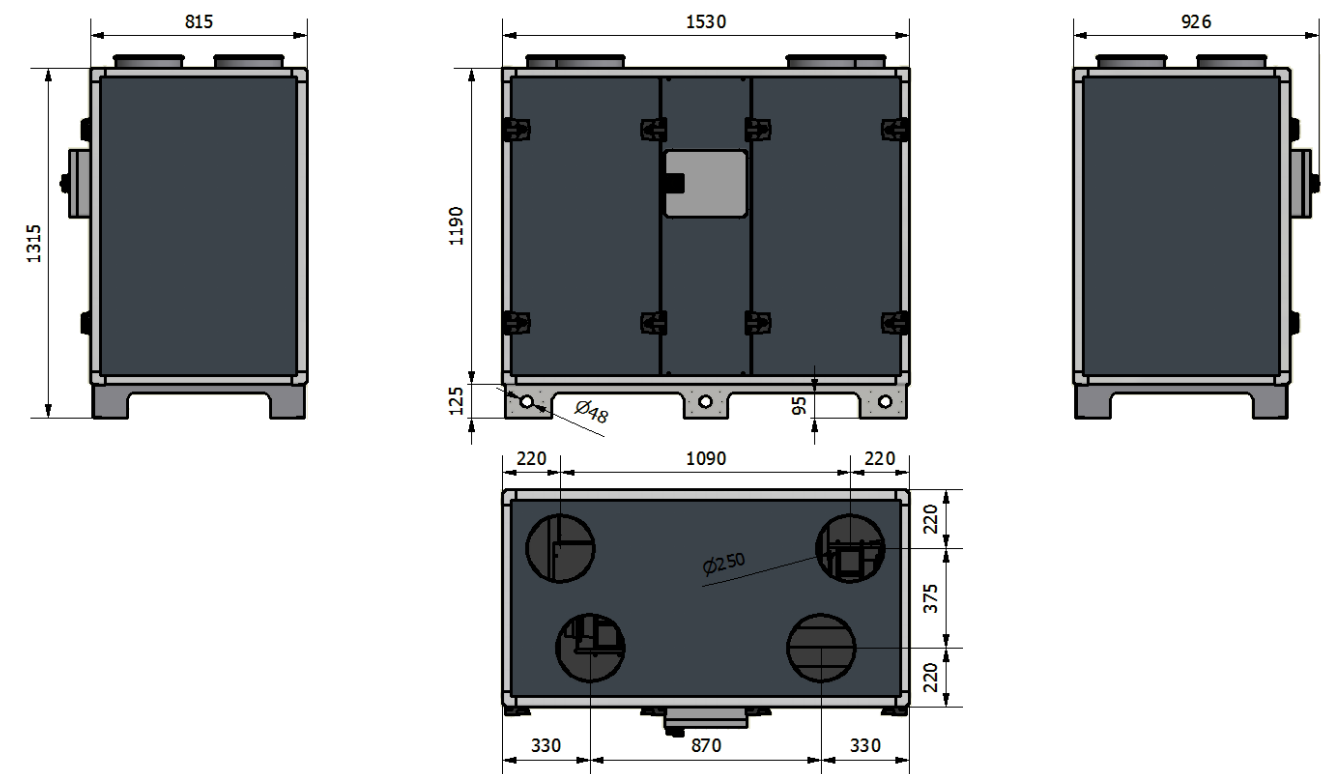

GLOBAL RX+ TOP 08

FAN DIAGRAMS

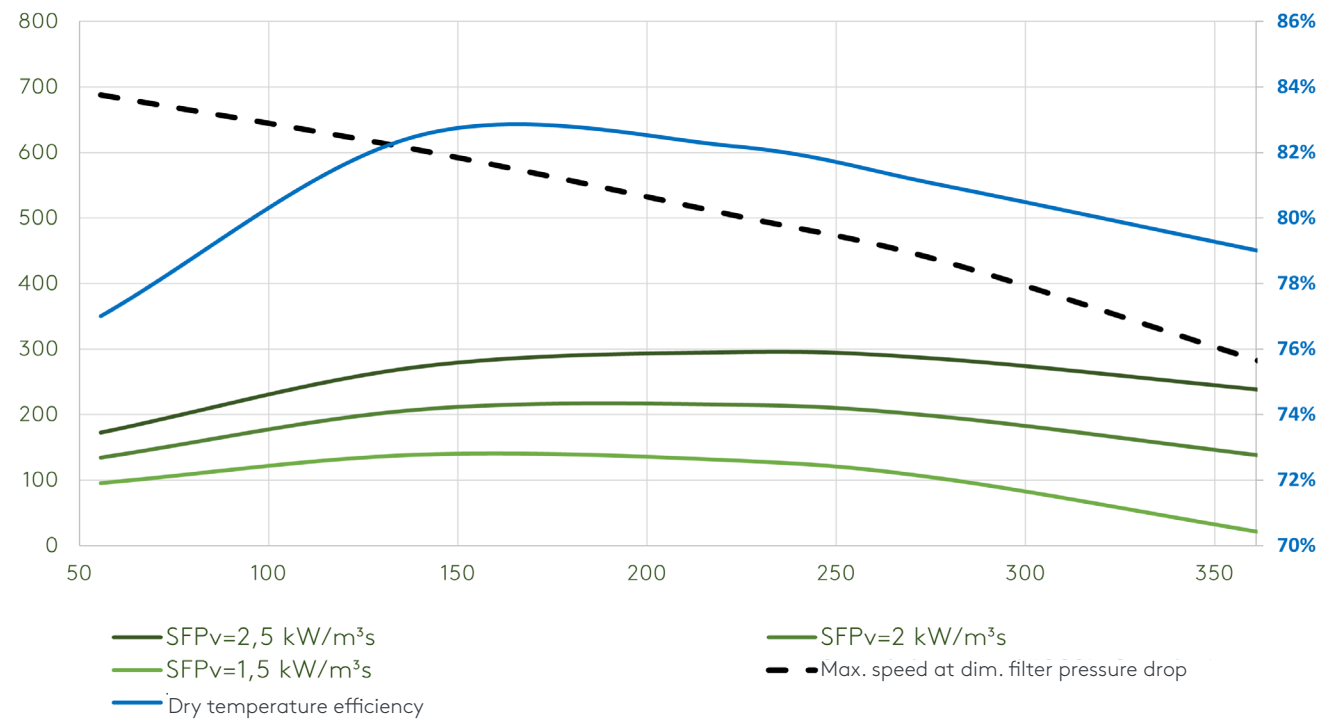

• AIRFLOW	200-1300 m ³ /h
• DIMENSIONS (L x W x H)	1530 x 815 x 1315
• WEIGHT	340 kg
• ELECTRIC POWER SUPPLY	1 x 230 V
• MAX. POWER CONSUMPTION	5.3 A
• RECOMMENDED FUSE PROTECTION	D6A - 10kA - AC3
• FILTER CLASS (BAG FILTER)	F7 (ePM1 70%) / M5 (ePM10 55%)
• STANDARD DUCT CONNECTIONS	Ø250
• GUIDE DUCT CONNECTIONS (20 mm)	NOT APPLICABLE
• AMBIENT TEMPERATURE	-20°C ... +50°C
• EN1886 CLASSIFICATION	T3/TB2/F9/L2/D2

AIRFLOW	Pa ext	SFP _v	Speed dim. used/Max, supply air	Speed dim. used/Max, extract air	POWER CONSUMPTION	Dry temperature efficiency	Conditions
m ³ /h	l/s	kW/m ³ s	%	%	kW	%	
200	56	200	2.8	57	56	0.2	77%
500	139	200	1.9	67	66	0.3	83%
800	222	200	1.9	77	78	0.4	82%
1000	278	200	2.0	84	86	0.6	81%
1300	361	200	2.3	95	98	0.8	79%

1. Calculated values at 200 Pa ext. pressure (150/50 Pa)
2. All data applies to fans with composite fan impeller and heat exchangers with efficiency class Premium
3. SFP and absorbed power calculated with clean filter
4. Speed dim. calculated at dim. filter pressure drop

DIMENSIONS (mm)

GLOBAL RX+ TOP 08

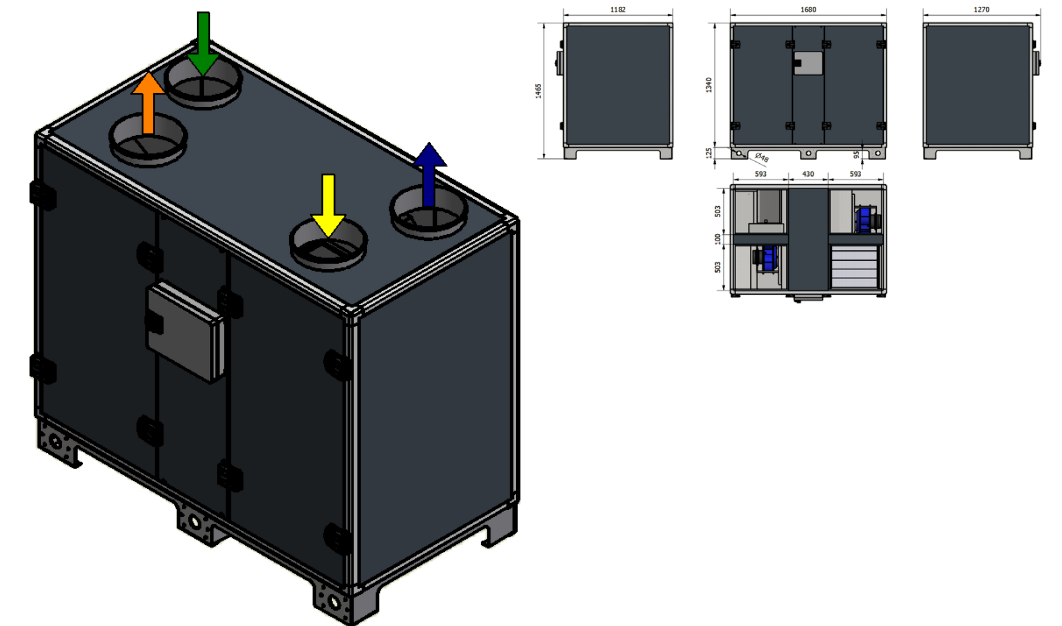
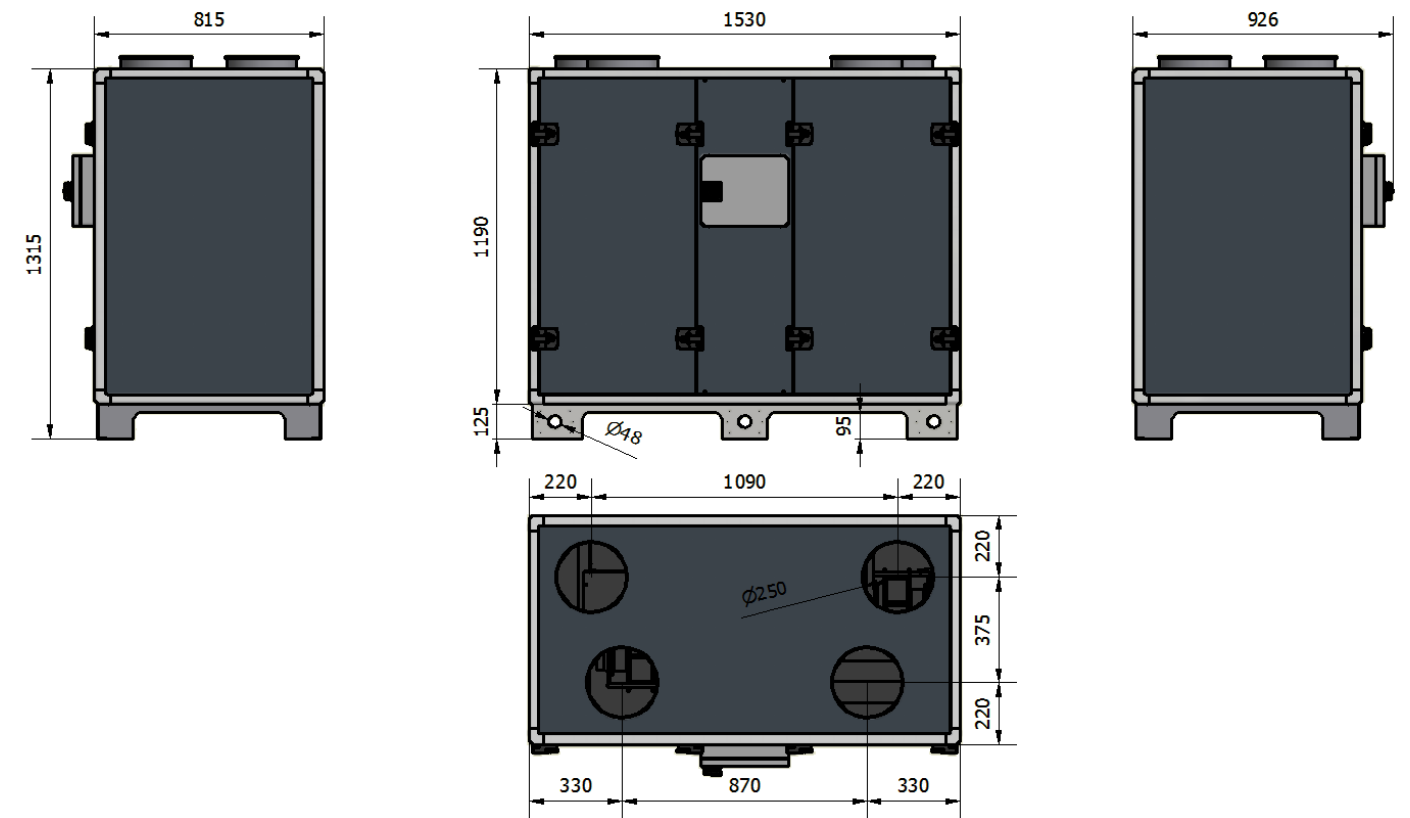

Right connection version

Left connection version

GLOBAL RX+ TOP 10

FAN DIAGRAMS

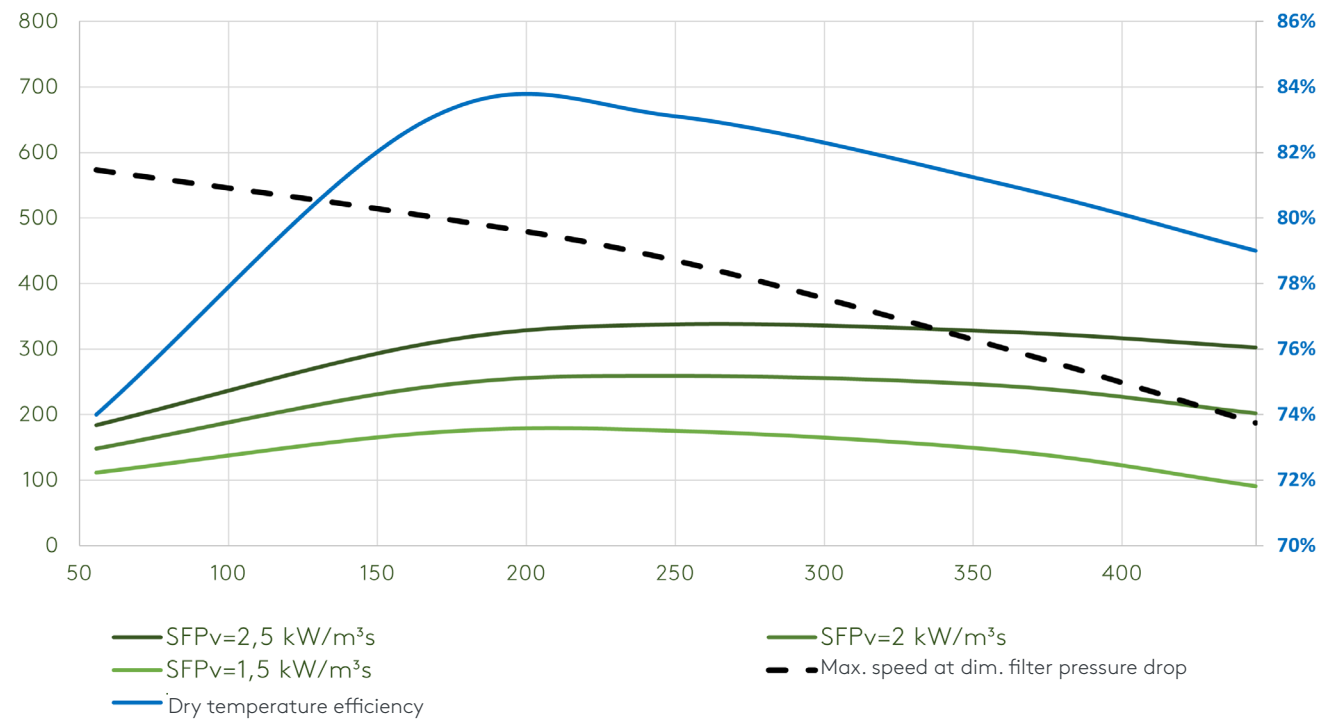

• AIRFLOW	200-1600 m ³ /h
	56-445 l/s
• DIMENSIONS (L x W x H)	1680 x 885 x 1465
• WEIGHT	360 kg
• ELECTRIC POWER SUPPLY	1 x 230 V
• MAX. POWER CONSUMPTION	4.9 A
• RECOMMENDED FUSE PROTECTION	D6A - AC3 - 10kA
• FILTER CLASS (BAG FILTER)	F7 (ePM1 70%) / M5 (ePM10 55%)
• STANDARD DUCT CONNECTIONS	Ø315
• GUIDE DUCT CONNECTIONS (20 mm)	NOT APPLICABLE
• AMBIENT TEMPERATURE	-20°C ... +50°C
• EN1886 CLASSIFICATION	T3/TB2/F9/L2/D2

AIRFLOW	Pa ext	SFP _v	Speed dim. used/Max, supply air	Speed dim. used/Max, extract air	POWER CONSUMPTION	Dry temperature efficiency	Conditions
m ³ /h	l/s	kW/m ³ /s	%	%	kW	%	
200	56	200	2.6	60	59	0.1	74%
600	167	200	1.7	70	69	0.3	83%
900	250	200	1.6	79	78	0.4	83%
1300	361	200	1.8	91	89	0.6	81%
1600	445	200	2.0	101	98	0.9	79%

1. Calculated values at 200 Pa ext. pressure (150/50 Pa)
 2. All data applies to fans with composite fan impeller and heat exchangers with efficiency class Premium
 3. SFP and absorbed power calculated with clean filter
 4. Speed dim. calculated at dim. filter pressure drop

DIMENSIONS (mm)

GLOBAL RX+ TOP 10

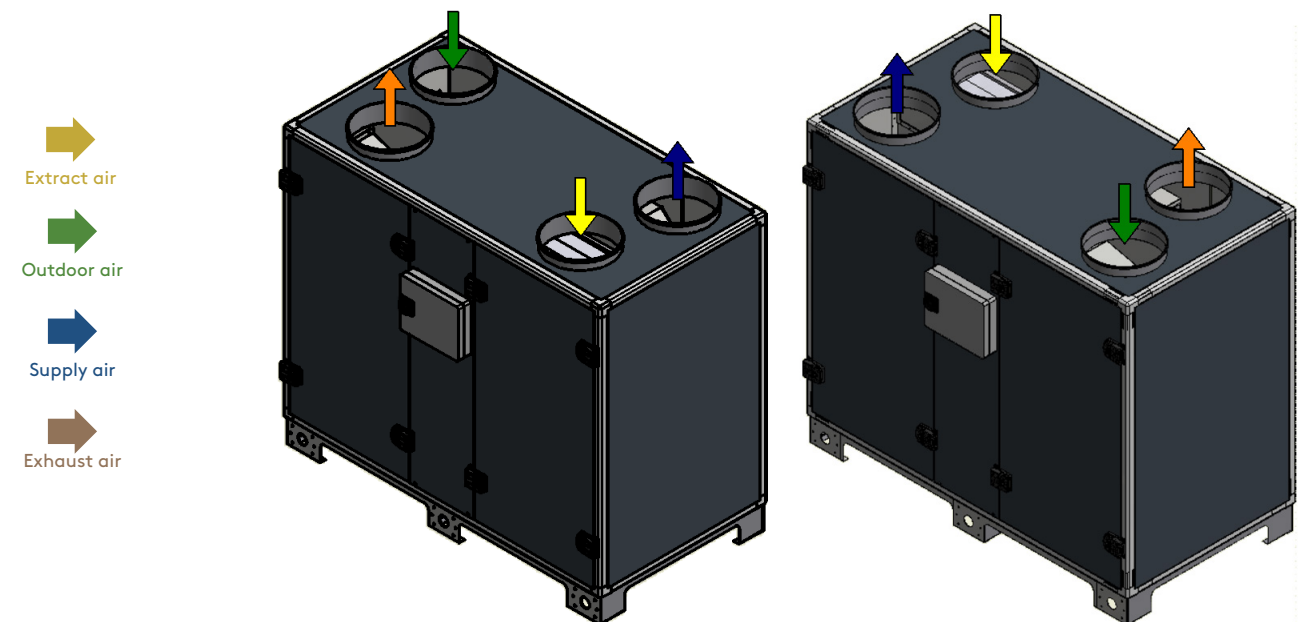
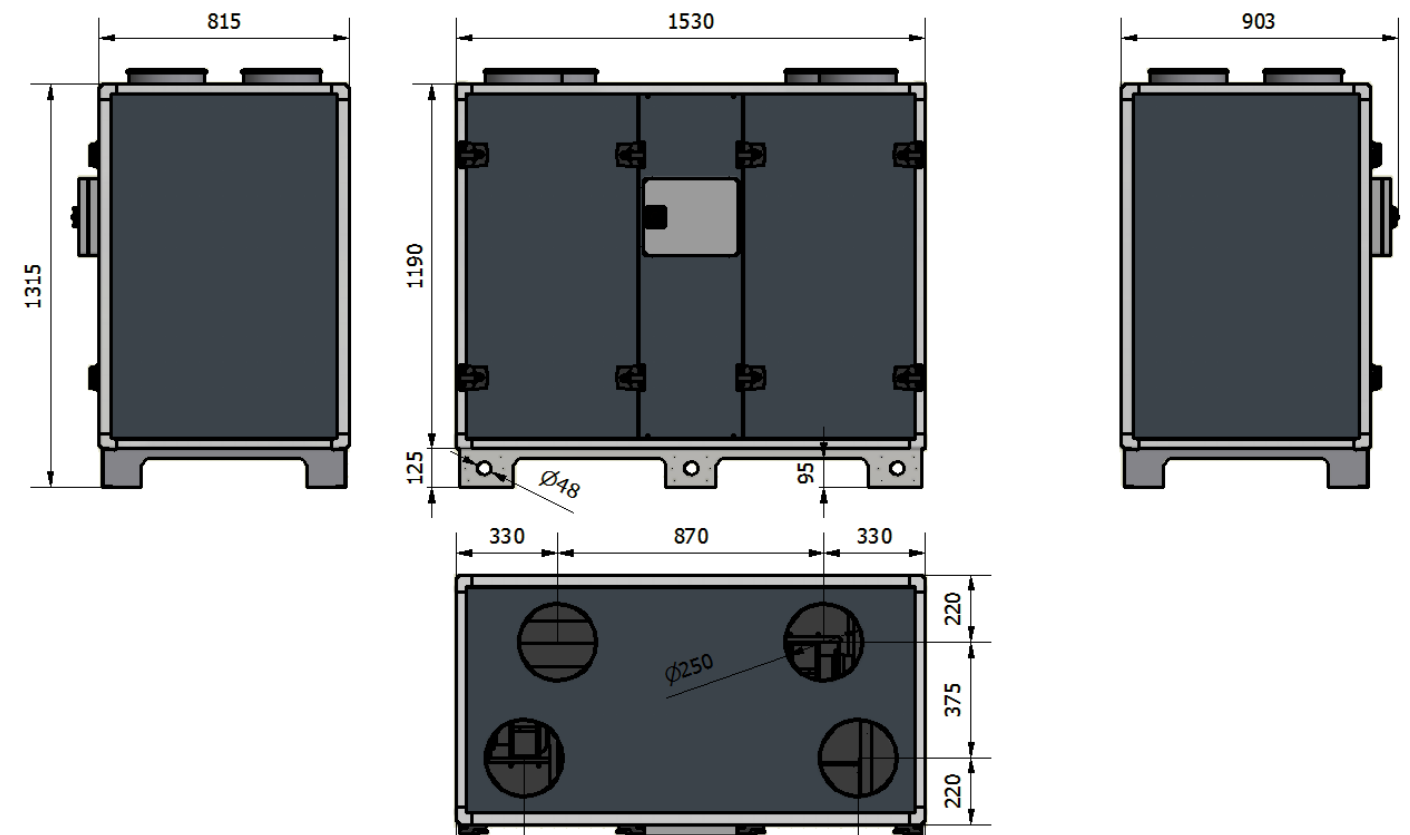

Right connection version

Left connection version

GLOBAL RX+ TOP 12

FAN DIAGRAMS

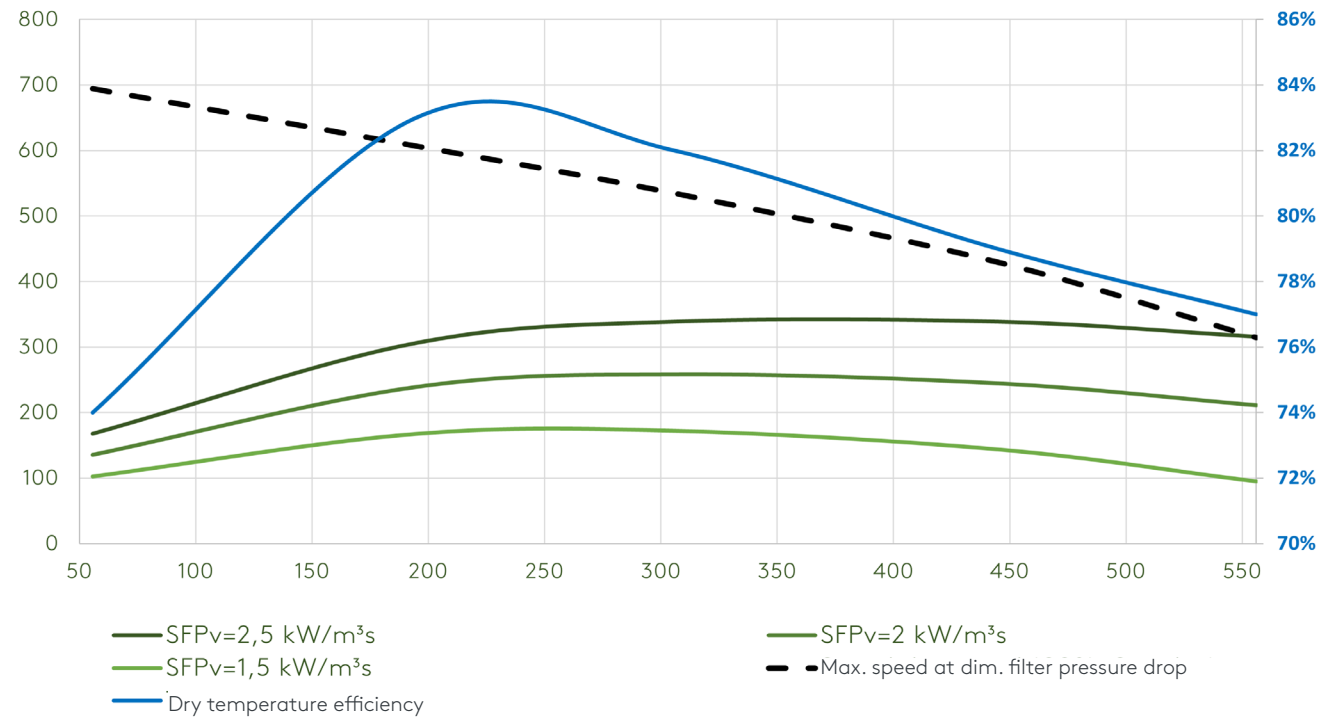

• AIRFLOW	200–2000 m ³ /h
	56–556 l/s
• DIMENSIONS (L x W x H)	1680 x 885 x 1465
• WEIGHT	355 kg
• ELECTRIC POWER SUPPLY	1 x 230 V
• MAX. POWER CONSUMPTION	7.7 A
• RECOMMENDED FUSE PROTECTION	D10A - 10kA - AC3
• FILTER CLASS (BAG FILTER)	F7 (ePM1 70%) / M5 (ePM10 55%)
• STANDARD DUCT CONNECTIONS (15 mm)	590 x 350
• GUIDE DUCT CONNECTIONS (20 mm) (W x H)	600 x 300
• AMBIENT TEMPERATURE	-20°C ... +50°C
• EN1886 CLASSIFICATION	T3/TB2/F9/L2/D2

AIRFLOW	Pa ext	SFP _v	Speed dim. used/Max, supply air	Speed dim. used/Max, extract air	POWER CONSUMPTION	Dry temperature efficiency	Conditions
m ³ /h	l/s	kW/m ³ /s	%	%	kW	%	
200	56	200	2.9	55	55	0.2	74%
700	195	200	1.7	65	65	0.3	83%
1100	306	200	1.6	74	74	0.5	82%
1600	445	200	1.8	84	85	0.8	79%
2000	556	200	2.0	92	93	1.1	77%

1. Calculated values at 200 Pa ext. pressure (150/50 Pa)
2. All data applies to fans with composite fan impeller and heat exchangers with efficiency class Premium
3. SFP and absorbed power calculated with clean filter
4. Speed dim. calculated at dim. filter pressure drop

DIMENSIONS (mm)

GLOBAL RX+ TOP 12

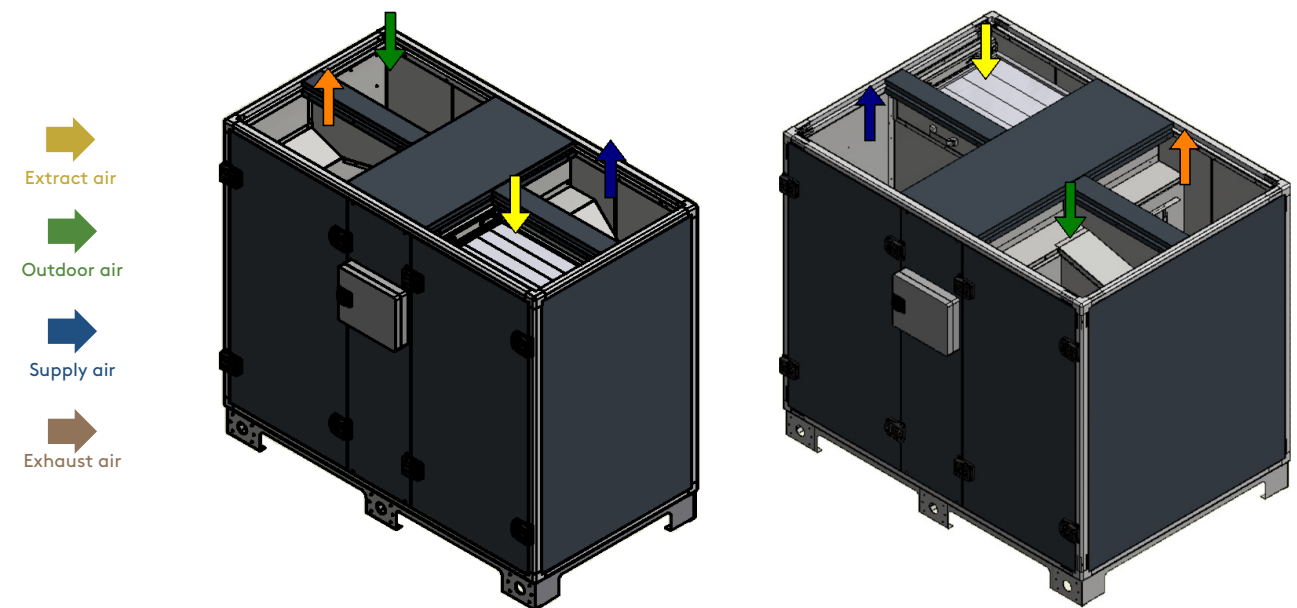
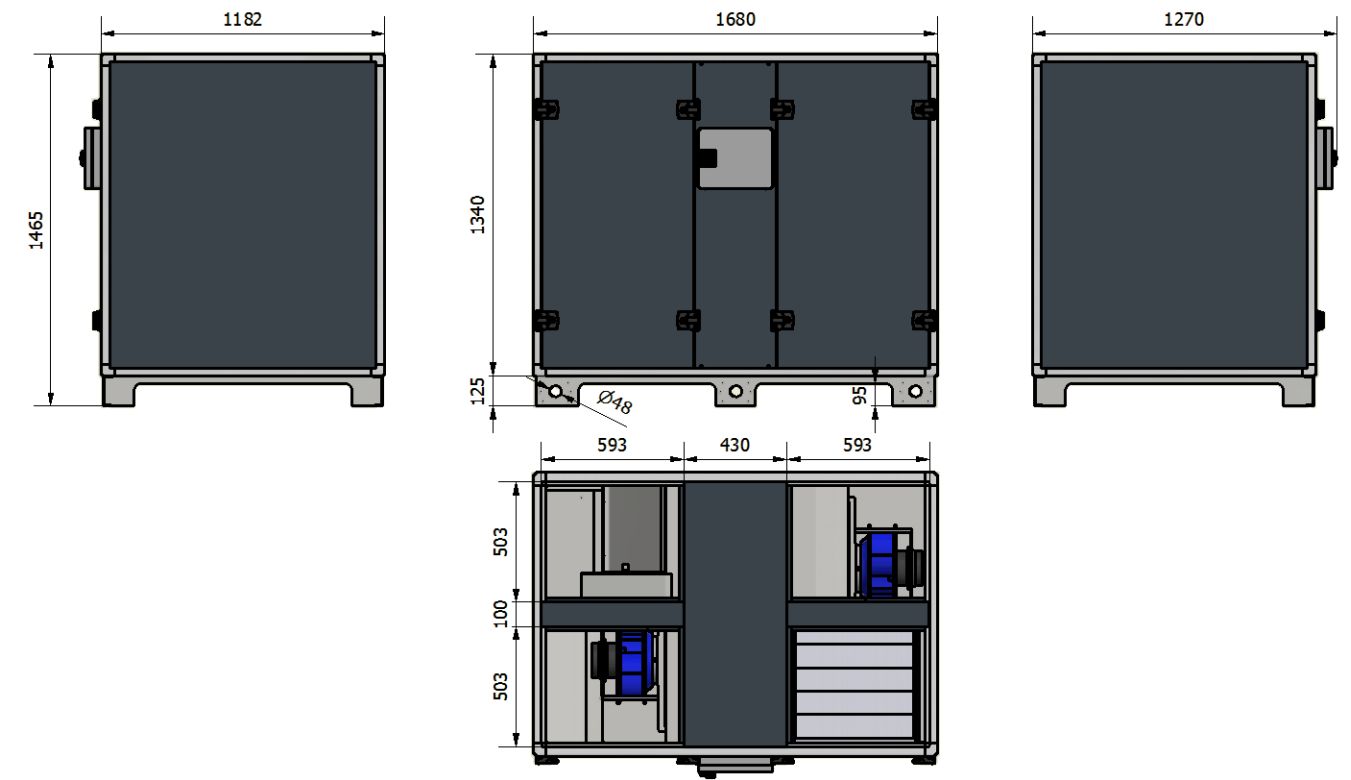

Right connection version

Left connection version

GLOBAL RX+ TOP 13

FAN DIAGRAMS

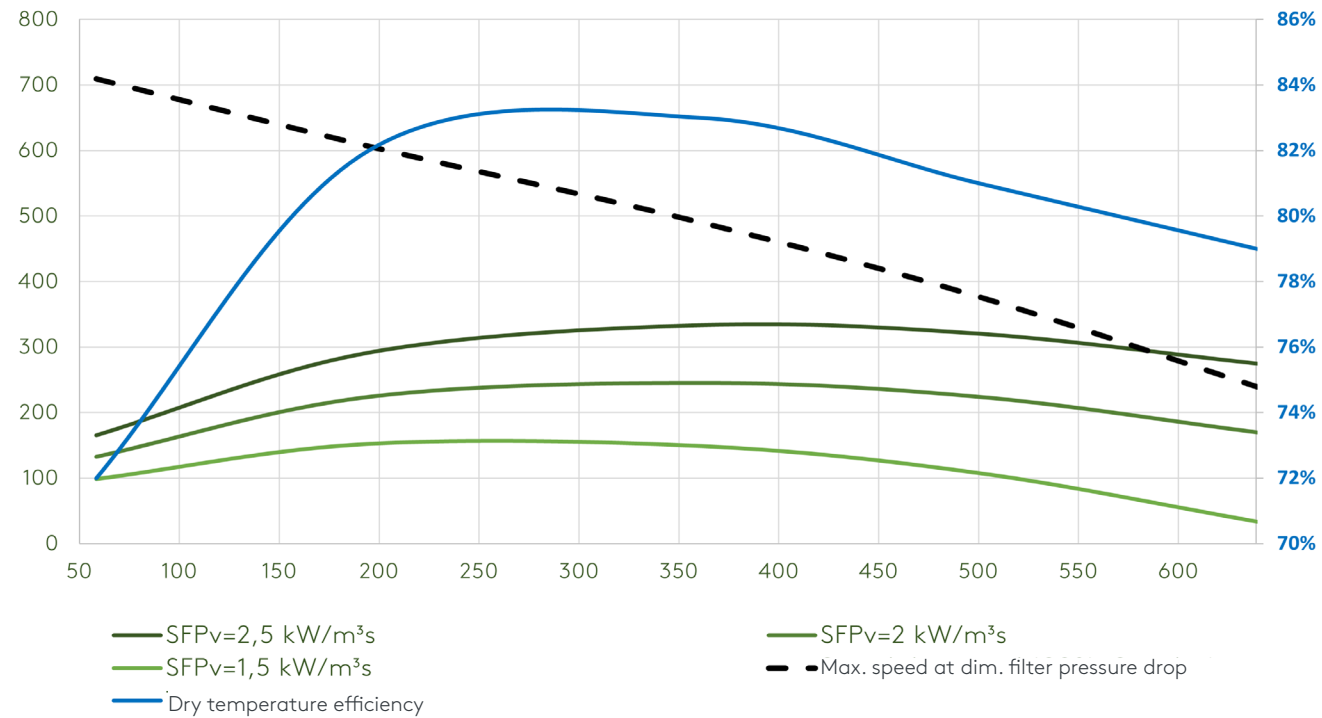

• AIRFLOW	210–2300 m ³ /h
	58–639 l/s
• DIMENSIONS (L x W x H)	1680 x 995 x 1465
• WEIGHT	385 kg
• ELECTRIC POWER SUPPLY	1 x 230 V
• MAX. POWER CONSUMPTION	7.7 A
• RECOMMENDED FUSE PROTECTION	D10A - 10kA - AC3
• FILTER CLASS (BAG FILTER)	F7 (ePM1 70%) / M5 (ePM10 55%)
• STANDARD DUCT CONNECTIONS (15 mm)	590 x 400
• GUIDE DUCT CONNECTIONS (20 mm) (W x H)	600 x 400
• AMBIENT TEMPERATURE	-20 ... +50°C
• EN1886 CLASSIFICATION	T3/TB2/F9/L2/D2

AIRFLOW	Pa ext	SFPv	Speed dim. used/Max, supply air	Speed dim. used/Max, extract air	POWER CONSUMPTION	Dry temperature efficiency	Conditions
m ³ /h	l/s	kW/m ³ /s	%	%	kW	%	
210	58	200	2.9	55	55	0.2	72%
700	195	200	1.8	65	65	0.3	82%
1300	361	200	1.7	77	77	0.6	83%
1800	500	200	1.9	87	88	0.9	81%
2300	639	200	2.1	98	98	1.4	79%

1. Calculated values at 200 Pa ext. pressure (150/50 Pa)
2. All data applies to fans with composite fan impeller and heat exchangers with efficiency class Premium
3. SFP and absorbed power calculated with clean filter
4. Speed dim. calculated at dim. filter pressure drop

DIMENSIONS (mm)

GLOBAL RX+ TOP 13

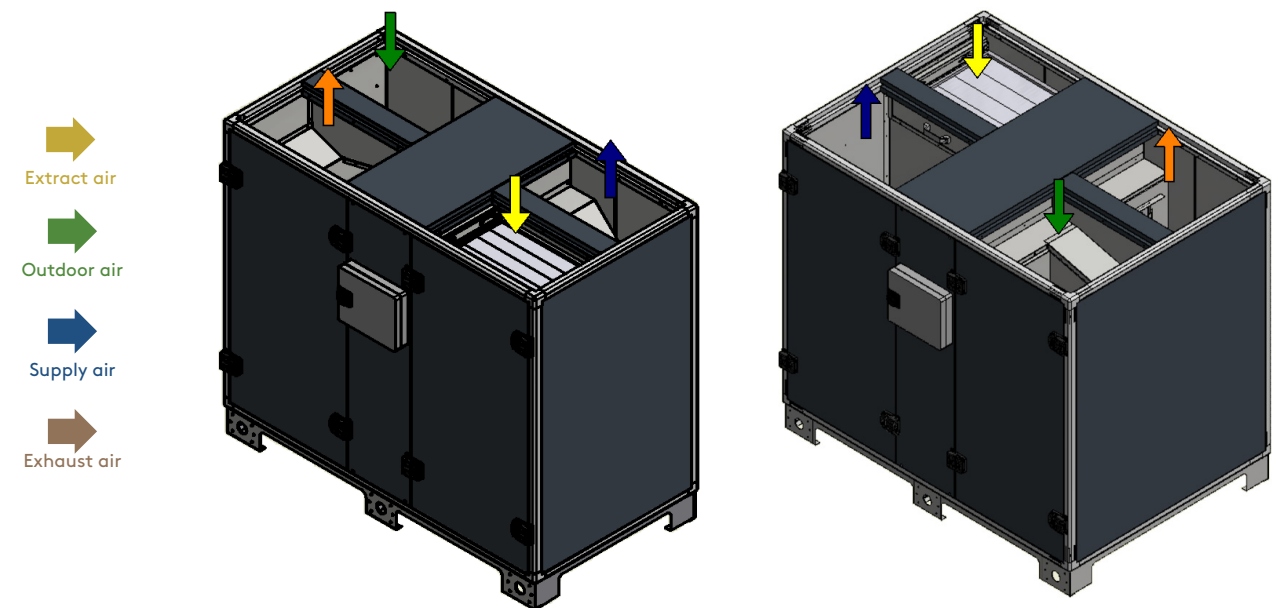
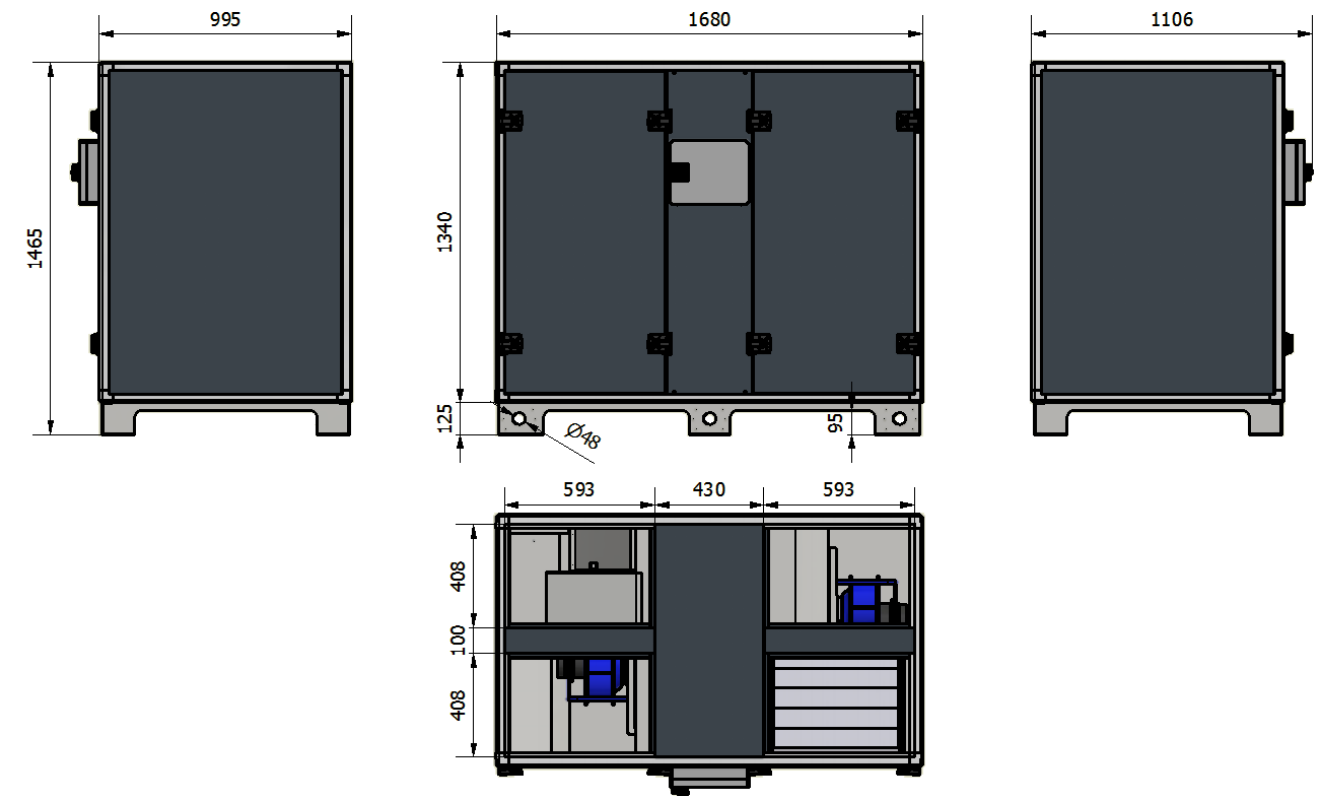

Right connection version

Left connection version

GLOBAL RX+ TOP 14

FAN DIAGRAMS

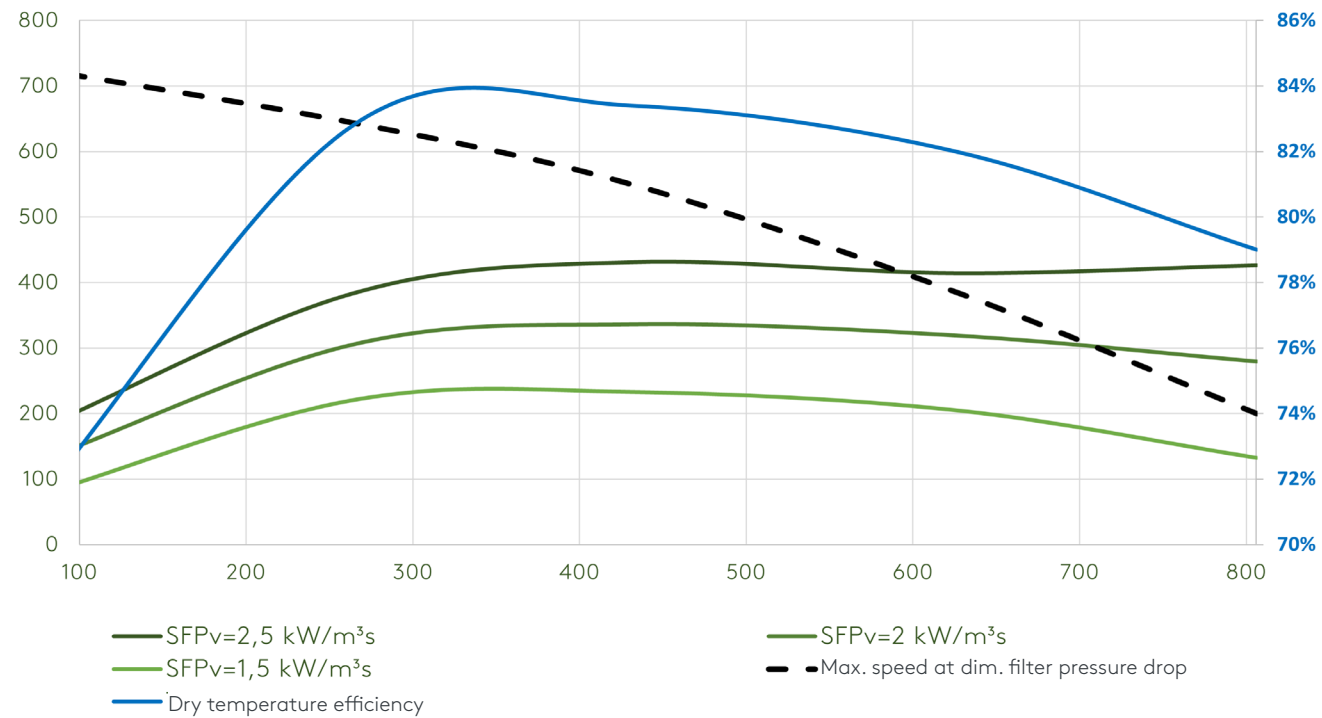

• AIRFLOW	250–2900 m³/h
• DIMENSIONS (L x W x H)	1680 x 1182 x 1465
• WEIGHT	390 kg
• ELECTRIC POWER SUPPLY	1 x 230 V
• MAX. POWER CONSUMPTION	7.7 A
• RECOMMENDED FUSE PROTECTION	D10A - 10kA - AC3
• FILTER CLASS (BAG FILTER)	F7 (ePM1 70%) / M5 (ePM10 55%)
• STANDARD DUCT CONNECTIONS (15 mm)	590 x 500
• GUIDE DUCT CONNECTIONS (20 mm) (W x H)	600 x 500
• AMBIENT TEMPERATURE	-20°C ... +50°C
• EN1886 CLASSIFICATION	T3/TB2/F9/L2/D2

AIRFLOW	Pa ext	SFPv	Speed dim. used/Max, supply air	Speed dim. used/Max, extract air	POWER CONSUMPTION	Dry temperature efficiency	Conditions
m³/h	l/s	kW/m³/s	%	%	kW	%	
250	70	200	58	57	0.2	71%	
950	264	200	64	64	0.4	83%	
1550	431	200	75	74	0.6	83%	
2250	626	200	87	86	0.9	82%	
2900	806	200	100	98	1.4	79%	

1. Calculated values at 200 Pa ext. pressure (150/50 Pa)
2. All data applies to fans with composite fan impeller and heat exchangers with efficiency class Premium
3. SFP and absorbed power calculated with clean filter
4. Speed dim. calculated at dim. filter pressure drop

DIMENSIONS (mm)

GLOBAL RX+ TOP 14

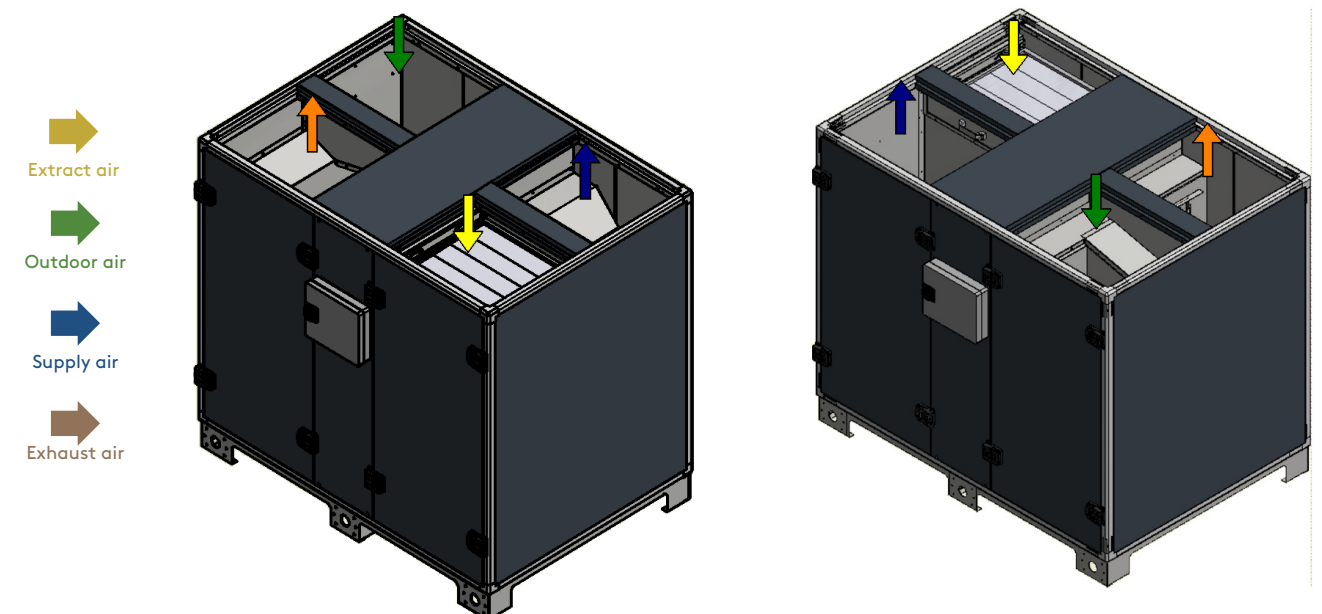
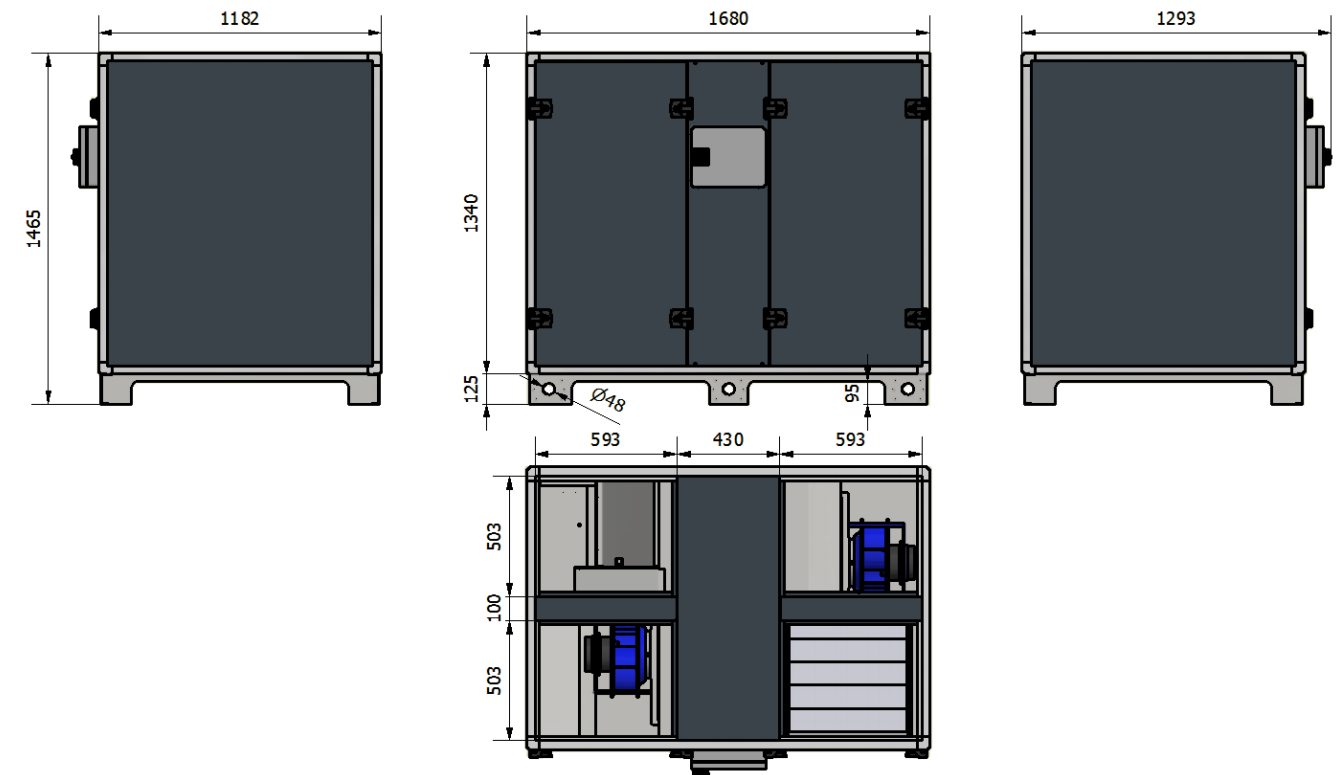

Right connection version

Left connection version

GLOBAL RX+ TOP 16

FAN DIAGRAMS

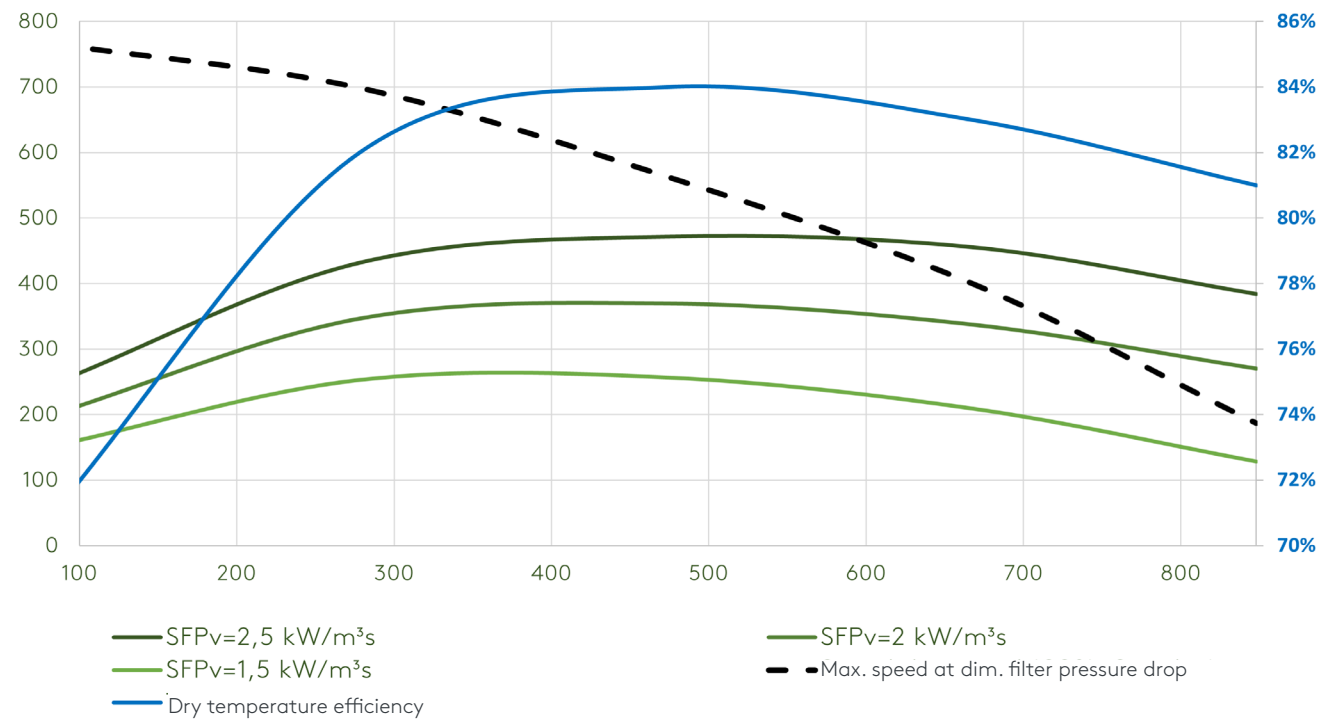

• AIRFLOW	300-3050 m³/h
	83-848 l/s
• DIMENSIONS (L x W x H)	1680 x 1182 x 1465
• WEIGHT	470 kg
• ELECTRIC POWER SUPPLY	1 x 230 V
• MAX. POWER CONSUMPTION	7.7 A
• RECOMMENDED FUSE PROTECTION	D10A - 10kA - AC3
• FILTER CLASS (BAG FILTER)	F7 (ePM1 70%) / M5 (ePM10 55%)
• STANDARD DUCT CONNECTIONS (15 mm)	590 x 500
• GUIDE DUCT CONNECTIONS (20 mm) (W x H)	600 x 500
• AMBIENT TEMPERATURE	-20°C ... +50°C
• EN1886 CLASSIFICATION	T3/TB2/F9/L2/D2

AIRFLOW	Pa ext	SFPv	Speed dim. used/Max, supply air	Speed dim. used/Max, extract air	POWER CONSUMPTION	Dry temperature efficiency	Conditions
m³/h	l/s	kW/m³s	%	%	kW	%	
300	83	200	53	53	0.2	71%	
1000	278	200	63	63	0.3	82%	
1700	473	200	75	76	0.6	84%	
2400	667	200	88	89	1.0	83%	
3050	848	200	101	101	1.5	81%	

1. Calculated values at 200 Pa ext. pressure (150/50 Pa)
 2. All data applies to fans with composite fan impeller and heat exchangers with efficiency class Premium
 3. SFP and absorbed power calculated with clean filter
 4. Speed dim. calculated at dim. filter pressure drop

DIMENSIONS (mm)

GLOBAL RX+ TOP 16

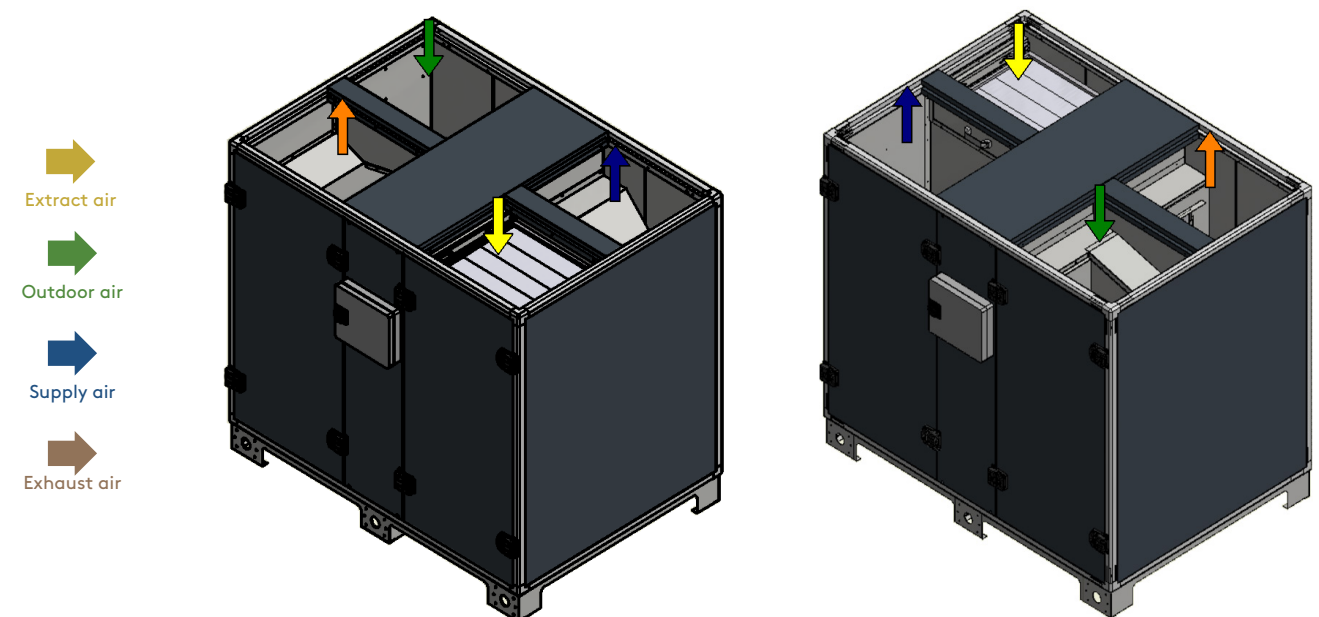
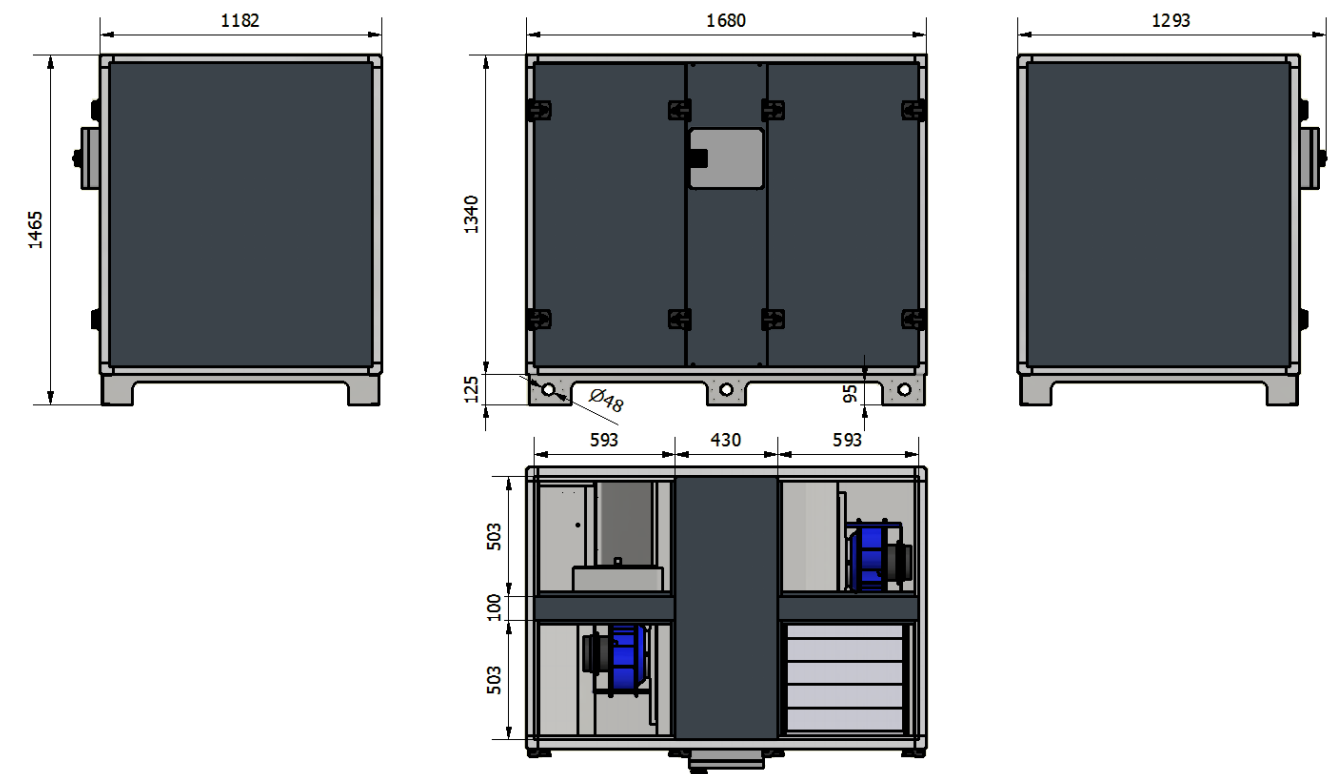

Right connection version

Left connection version

GLOBAL RX TOP



Designation key:

Efficiency, heat exchanger:
Standard (RX TOP) / Premium (RX TOP+)

Unit size: 05, 08, 10, 12, 13, 14, 16, ...

Supply air: right (R) / left (L)

Fan type: none = composite, ALU = aluminium

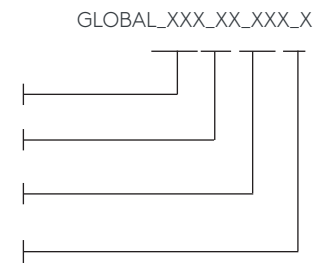

FLEXIBLE CONNECTION 20 MM



The flexible duct connections, type MS20, prevent vibrations from being propagated through the duct system. The connections are made of glass fibre-reinforced plastic and have fire resistance class M0 and air tightness class B (according to EN 15727 and EN 1751). They can handle operating temperatures from -30 to +110°C and pressure up to 2000 Pa. The 20 mm wide sleeve connection is made of 1 mm thick, galvanised sheet steel.

Designation key:

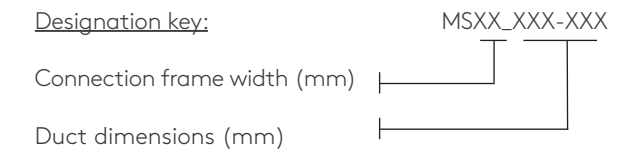

MODEL	INTERNAL DIMENSIONS [MM]	EXTERNAL DIMENSIONS [MM]	SYMBOL
GLOBAL RX 12 TOP	550 x 310	590 x 350	MS20_550-310
GLOBAL RX 13 TOP	550 x 360	590 x 400	MS20_550-360
GLOBAL RX 14/16 TOP	550 x 460	590 x 500	MS20_550-460
ECA 10/12	640 x 235	680 x 275	MS20_640-235
ECA 14/16	740 x 335	780 x 375	MS20_740-335

SLIP-CLAMP CONNECTIONS 20 MM



Slip-clamp connections mean that the duct is connected to the unit with a standard guide and guide rail. The connection frame is made of 1 mm thick, galvanised sheet steel. Slip-clamp connections can only be supplied with fixed dimensions with a 100 mm interval, see the table below.

Designation key:

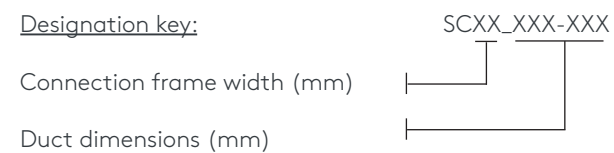

MODEL	DUCT CONNECTION [MM]	SYMBOL
GLOBAL RX 12 TOP	600 x 300	SC20_600-300
GLOBAL RX 13 TOP	600 x 400	SC20_600-400
GLOBAL RX 14/16 TOP	600 x 500	SC20_600-500
ECA 10/12	700 x 300	SC20_700x300
ECA 14/16	800 x 400	SC20_800x400

FLEXIBLE CONNECTION 30 MM

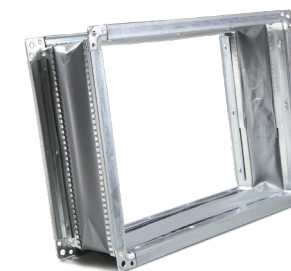

The flexible connections, type MS30, prevent vibrations from being propagated through the duct system. The connections are made of glass fibre-reinforced plastic and have fire resistance class M0 and air tightness class B (according to EN 15727 and EN 1751). They can handle operating temperatures from -30 to +110°C and pressure up to 2000 Pa. The 30 mm wide "METU" sleeve connection is made of 1 mm thick, galvanised sheet steel.

Designation key:

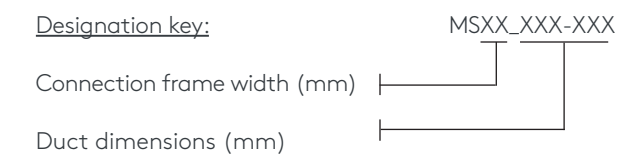

MODEL	INTERNAL DIMENSIONS [MM]	EXTERNAL DIMENSIONS [MM]	SYMBOL
GLOBAL RX 12 TOP	530 x 290	590x350	MS30_530-290
GLOBAL RX 13 TOP	530 x 340	590 x 400	MS30_530-340
GLOBAL RX 14/16 TOP	530 x 440	590x500	MS30_530-440
ECA 10/12	650 x 215	710 x 275	MS30_620-215
ECA 14/16	720 x 315	780 x 375	MS30_720-315

REPLACEMENT FILTER SETS



The function of the filter is to keep both the air and the heat exchanger free from contaminants. Outdoor air filter class: ePM1 ≥ 70% Extract air filter class: ePM10 ≥ 55%. All filters are classified in accordance with both ISO EN 779 and ISO EN 16890. In order to keep the heat exchanger clean, filters of class ePM10 ≥ 55% are sufficient. In order to avoid impaired energy efficiency in the air handling unit, extract air filter sets of class ePM1 ≥ 70% are not supplied.

MODEL	DIMENSIONS, SUPPLY AIR [MM]		DIMENSIONS, EXTRACT AIR [MM]	
GLOBAL RX 05/08 TOP	640 x 385 x 380	ePM1 70%	335 x 457 x 360	ePM10 55%
GLOBAL RX 10/12 TOP	720 x 460 x 380	ePM1 70%	387 x 532 x 360	ePM10 55%
GLOBAL RX 13 TOP	720 x 460 x 380	ePM1 70%	433 x 532 x 360	ePM10 55%
GLOBAL RX 14/16 TOP	900 x 460 x 380	ePM1 70%	527 x 532 x 360	ePM10 55%

PRE-FILTER CLASS G4

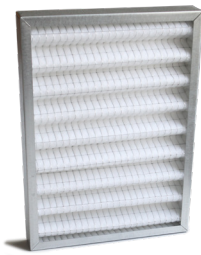

The pre-filter is installed in the outdoor air section, upstream of the fine filter. A pre-filter is used when the outdoor air is heavily contaminated, in order to prevent the fine filter from clogging up unreasonably quickly. The pre-filter has filter class G4 according to EN-779.

MODEL	DIMENSIONS [MM]
GLOBAL RX 05/08 TOP	640 x 385 x 23
GLOBAL RX 10/12/13 TOP	720 x 460 x 230
GLOBAL RX 14/16 TOP	900 x 460 x 23

BUILT-IN WATERBORNE POST-HEATER

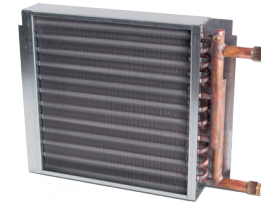

In the post-heater, hot water is used to reheat the supply air. The heater is integrated in the air handling unit, downstream of the heat exchanger. The heat exchanger is a tube heat exchanger, made of copper pipes supplied with surface-enlarging aluminium fins with a spacing of 2.5 mm. The pipes have external threaded pipe connections are made of brass. The heat exchanger is equipped with a venting plug. The pressure class is PN16.

Designation key:

Heater type and number of rows

Size

IBA_XX-XX

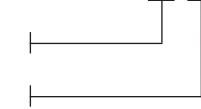

MODEL	Ø	SYMBOL
GLOBAL RX 05/08 TOP	1/2-Zoll	IBA_2H_08
GLOBAL RX 10/12 TOP	1/2-Zoll	IBA_2H_12
GLOBAL RX 13 TOP	1/2-Zoll	IBA_2H_13
GLOBAL RX 14/16 TOP	1/2-Zoll	IBA_2H_16

BUILT-IN ELECTRIC POST-HEATER

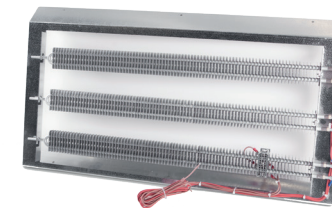

The electric heater is used to reheat the supply air. The heater is placed between the rotary heat exchanger and the supply air fan. The electric heater is equipped with two overheating protection units, one with manual resetting (110°C) and the other with automatic resetting (75°C). All electrical connections are protected to prevent people from touching them.

Designation key:

Pre-/reheating (IN/OUT)

Heating capacity (kW)

Power supply: 1 = 3*400 V/2=3*230 V

Size

KW_XXX_XX-X_XX/XX

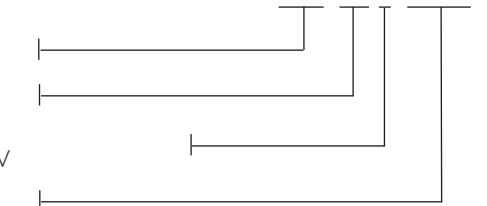

MODEL	CAPACITY	SYMBOL
GLOBAL RX 05 TOP	4.5 kW	KW_OUT_4.5_x_05
GLOBAL RX 08 TOP	6.0 kW	KW_OUT_6_x_08
GLOBAL RX 10/12 TOP	6.0 kW	KW_OUT_6-x_10/12
GLOBAL RX 13 TOP	9.0 kW	KW_OUT_9_x_13
GLOBAL RX 14 TOP	9.0 kW	KW_OUT_9_x_14
GLOBAL RX 16 TOP	12.0 kW	KW_OUT_12_x_16

INSULATED INTEGRATED CASING FOR EXTERNAL HEATERS/COOLERS



The insulated integrated casing has a sandwich construction, made of galvanised sheet steel with 30 mm thick mineral wool insulation between the outer and the inner sheet steel. The outer sheet steel is painted in colour RAL7016. The casings can be used for the integration of external heaters, coolers and direct expansion units (EBA), and can be installed directly on the unit or in the duct system. The standard sleeve connection is 15 mm. Other connection types are available as options: 20 mm guide rails, 30 mm "METU" connections.

Designation key:

Duct dimensions (mm)
Casing dimensions (mm)

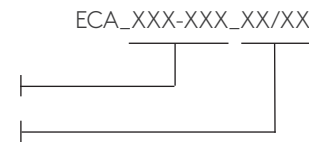

MODEL	DUCT CONNECTION [MM]	SYMBOL
GLOBAL RX 05/08 TOP	Ø 250	ECA_250_08
GLOBAL RX 10/12/13 TOP	655 x 250	ECA_655-250_13
GLOBAL RX 14/16 TOP	755 x 350	ECA_755-350_16

CIRCULAR/RECTANGULAR ADAPTER



Uninsulated adapters for the transition between circular and rectangular connections are available for units and post-treatment sections with rectangular connections. The adapters are made of galvanised sheet steel. The circular duct connection is fitted with a rubber seal.

Designation key:

The rectangular connection's external dimensions
The circular connection's diameter

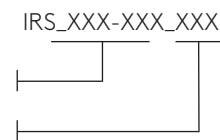

MODEL	DIMENSIONS	SYMBOL
GLOBAL RX 12 TOP	625 x 385 - Ø 355	IRS_625-385_355
GLOBAL RX 13 TOP	625 x 440 - Ø 355	IRS_625-440_355
GLOBAL RX 14/16 TOP	625 x 535 - Ø 400	IRS_625-535_400
ECA 10	680 x 275 - Ø 315	IRS_680-275_315
ECA 12/13	680 x 275 - Ø 355	IRS_680-275_355
ECA 14/16	780 x 375 - Ø 400	IRS_780-375_400

HEAT EXCHANGER FOR INTEGRATION IN INSULATED CASING

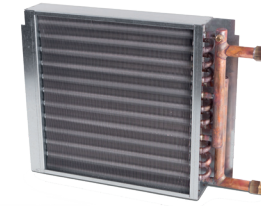

In the EBA heat exchanger, water or refrigerant is used to post-treat the supply air. The heat exchanger is designed for integration in insulated casing ECA. The heat exchanger is a tube heat exchanger, made of copper pipe and aluminum fins with a spacing of 2.5 mm. The pipes have external threaded pipe connections are made of brass. The heat exchanger is supplied with a venting plug (not for DX). The pressure class is PN16.

Designation key:

Function and number of rows
Size

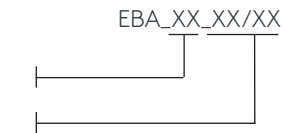

MODEL	FEATURES	# NUMBER OF ROWS	DIMENSIONS [MM]	SYMBOL
GLOBAL RX 05/08 TOP	HEATING	4	305 x 130 x 638	EBA_4H_08
GLOBAL RX 05/08 TOP	COOLING	4	305 x 130 x 638	EBA_4C_08
GLOBAL RX 05/08 TOP	DX	4	305 x 130 x 638	EBA_4X_08
GLOBAL RX 10/12/13 TOP	HEATING	4	305305130828	EBA_4H_13
GLOBAL RX 10/12/13 TOP	COOLING	4	305 x 130 x 828	EBA_4C_13
GLOBAL RX 10/12/13 TOP	DX	4	303 x 130 x 828	EBA_4X_13
GLOBAL RX 14/16 TOP	HEATING	4	405 x 130 x 938	EBA_4H_16
GLOBAL RX 14/16 TOP	COOLING	4	405 x 130 x 938	EBA_4C_16
GLOBAL RX 14/16 TOP	DX	4	405 x 130 x 938	EBA_4X_16

MOTOR-DRIVEN DAMPER



The CT dampers are used as shut-off dampers. Shut-off dampers are used if the air handling unit is not going to be used for a period of time, or if a waterborne heater or cooler is used. Rectangular shut-off dampers are factory installed and wired. The damper frame is made of galvanised steel, the damper blade in rectangular dampers is made of extruded aluminium. The damper blades have rubber seals. Air-tightness according to EN 1751 is class 3 for circular dampers and class 2 for rectangular dampers.

Designation key:

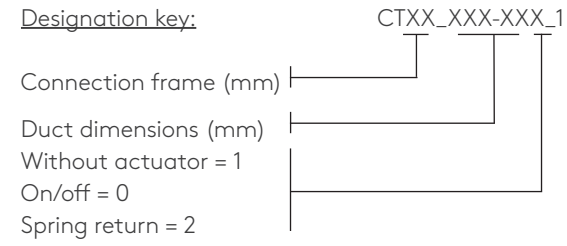

MODEL	INTERNAL DIMENSIONS [MM]	EXTERNAL DIMENSIONS [MM]	SYMBOL
GLOBAL RX 05/08 TOP	Ø250	Ø250	CT_250_x
GLOBAL RX 10 TOP	Ø315	Ø315	CT_315_x
GLOBAL RX 12/13 TOP	Ø355	Ø355	CT_355_x
GLOBAL RX 12 TOP	510 x 270	590 x 370	CT40_510-270_x
GLOBAL RX 13 TOP	510 x 320	590 x 400	CT40_510-230_x
GLOBAL RX 14/16 TOP	510 x 420	590x500	CT40_510-420_x
GLOBAL RX 14/16 TOP	Ø400	Ø400	CT_400_x

Feel good **inside**



Swegon 