

CDD/CDR

Circular ceiling diffuser for supply air - Flat upper section



QUICK FACTS

- Used with commissioning box ALS
- Cleanable
- Adjustable slot
- Perforated diffuser face = CDD
- Non-perforated diffuser face = CDR
- Standard colour White RAL 9003
 - 5 alternative standard colours
 - Other colours upon request

AIR FLOW - SOUND PRESSURE ROOM (Lp10A) *)							
CDD (CDR)		25 dB(A)		30 dB(A)		35 dB(A)	
Size		l/s	m³/h	l/s	m³/h	l/s	m³/h
100		33 (24)	119 (86)	37 (28)	133 (101)	44 (34)	158 (122)
125		44 (32)	158 (115)	49 (37)	176 (133)	56 (44)	202 (158)
160		70 (61)	252 (220)	82 (71)	295 (256)	95 (81)	342 (292)
200		95 (80)	342 (288)	110 (91)	396 (328)	120 (105)	432 (378)
250		115 (100)	414 (360)	135 (120)	486 (432)	160 (140)	579 (504)
315		150 (140)	540 (504)	180 (165)	648 (594)	210 (190)	759 (684)
CDD (CDR)	ALS	25 dB(A)		30 dB(A)		35 dB(A)	
Size	Size	l/s	m³/h	l/s	m³/h	l/s	m³/h
100	80-100	20 (21)	72 (76)	26 (27)	94 (97)	32 (32)	115 (115)
125	100-125	27 (26)	97 (94)	35 (33)	126 (119)	43 (41)	155 (148)
160	125-160	46 (46)	166 (166)	57 (58)	205 (209)	70 (72)	252 (260)
200	160-200	68 (69)	245 (248)	82 (82)	295 (295)	100 (100)	360 (360)
250	200-250	92 (90)	331(324)	120 (110)	432 (396)	140 (140)	504 (504)
315	250-315	135 (140)	486 (504)	160 (155)	576 (558)	190 (190)	684 (684)

Data applies to 360° spread pattern. Data for CDD in combination with ALS commissioning box is stated for a total pressure drop of 50 Pa. Values in brackets are for CDR.

*) Lp10A = Sound pressure incl. A-filter with 4 dB room attenuation and 10 m² room absorption area.

Contents

Technical description	3
Design	3
Materials and surface treatment.....	3
Accessories	3
Installation	3
Commissioning with ALS	3
Maintenance.....	3
Sizing	4
Sound data	4
CDR – Supply air	4
Engineering graphs	5
CDD, CDR with and without ALS	5
CDD/CDR – Supply air	5
Air diffuser only	5
CDD with ALS – Supply air.....	6
CDR with ALS – Supply air	7
Dimensions and weight.....	8
Order key	9
Specification example	9

Technical description

Design

The CDR and CDD consist of two parts: a flat upper section with a connection spigot having a rubber sealing ring, and a removable diffuser face. Between the upper section and the diffuser face there is a slot which has two alternative positions. The diffuser face of the CDR is non-perforated that of the CDD is perforated. Both CDD and CDR are equipped with acoustic insulation.

Materials and surface treatment

The upper section is manufactured in galvanized sheet steel. The diffuser face is made of sheet steel. The complete diffuser is painted both internally and externally.

- Standard colour:
 - White semi-gloss, lustre 40, RAL 9003/NCS S 0500-N
- Alternative standard colours:
 - Silver gloss, lustre 80, RAL 9006
 - Grey aluminium gloss, lustre 80, RAL 9007
 - Blanc semi-brillant, lustre 40, RAL 9010
 - Black semi-gloss, lustre 35, RAL 9005
 - Grey semi-gloss, lustre 30, RAL 7037
- Non-painted finish and other colours available on request.

Accessories

Commissioning box:

ALS. Is made of galvanized sheet steel and includes removable commissioning damper, fixed measurement unit and acoustic lining with a reinforced surface layer, to Fire Resistance Class B-s1,d0 according to EN ISO 11 925-2. Tightness class C on the housing according to SS-EN 12237.

Project planning

The diffuser has a completely flat upper surface, which means that it can be mounted fully sealed onto a concrete ceiling (Dimension for hole cut = nom. connection dimension + 5 mm).

Installation

When suspended freely, the inlet spigot of the diffuser is fixed to the connecting duct with blind rivets. When mounted sealed to the ceiling, the diffuser can be screwed in place through the upper surface if the building material is suitable. The diffuser face is removed by turning the springs which grip the pins through ¼ turn. When the commissioning box ALS is used, the spigot between the ALS and the CDD or CDR can be extended using normal circular duct by up to 500 mm long without the need to extend either the measurement tubes or the damper cords. See figure 1.

Commissioning with ALS

This must be carried out with the diffuser face in place. The measurement tubes and the damper cords are pulled out of the diffuser through the slots. The damper setting is lockable. See Figure 1.



Measurement accuracy and requirement on straight duct before the commissioning box, see Figure 1. The requirements of straight duct depends on the type of disturbance before the commissioning box. Figure 1 shows a bend, a dimensional change and a T-piece. Other types of disturbances requires at least 2xD straight (D = connection dimension) for measurement accuracy of $\pm 10\%$ of the flow.

The k-factor is stated on the product marking, and is also available in the relevant k-factor guide which can be downloaded at www.swegon.com.

Maintenance

The diffuser can be cleaned when necessary using luke warm water with added detergent. The duct system can be accessed without the use of tools. The diffuser face is removed by turning the springs which grip the pins of the diffuser face through ¼ turn. If the commissioning box ALS is used, move the diffusion plate aside and the damper unit can then be removed by unscrewing it from its fastening by hand.

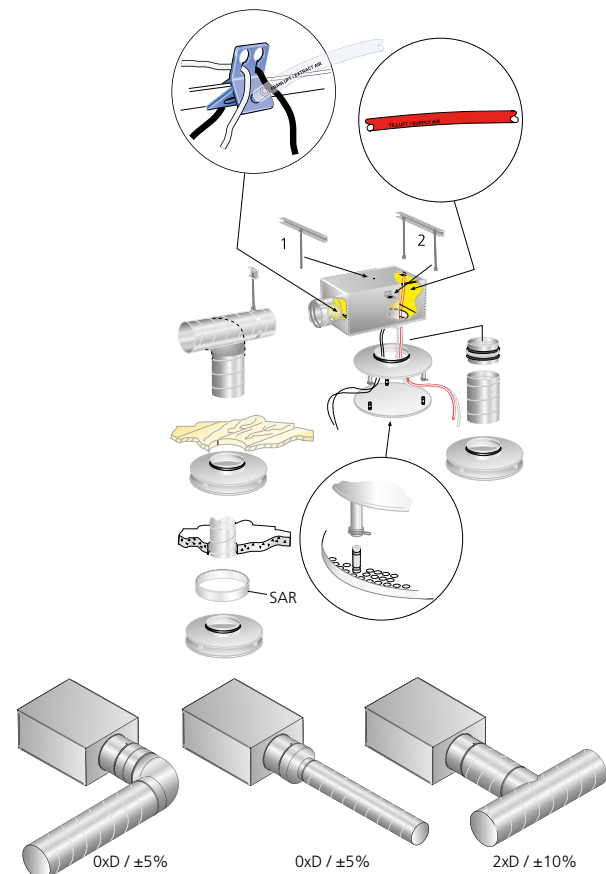

Figure 1. Installation. Commissioning.

Sizing

- Sound pressure level dB(A) applies to rooms with 10 m² equivalent sound absorption area.
- Sound attenuation (ΔL) below is shown in the octave band. Orifice attenuation is included in the values.
- The throw $l_{0,2}$ is measured under isothermal flow conditions
- Recommended maximum under temperature of 10 K.
- All technical data applies to the following slot widths:
20 mm for sizes 100 and 125.
30 mm for sizes 160, 200, 250 and 315.

- The slot widths can be increased to: 30 mm for sizes 100 and 125. 40 mm for sizes 160, 200, 250 and 315. These increased slot widths cause reduce in throw, pressure drop and sound levels by 20%. For calculating the width of the air stream, air velocities in the occupied zone or sound levels in rooms with other dimensions, please refer to our web calculation softwares available for download at www.swegon.com
- All the technical data applies to a 360° spread pattern.

L_w = Sound power level

L_{p10A} = Sound pressure level dB (A)

K_{ok} = Correction for producing the L_w value in the octave band

$L_w = L_{p10A} + K_{ok}$ gives the frequency divided octave band

Sound data

CDD – Supply air

Sound effect level L_w (dB)

Table K_{ok}

Size CDD	Mid-frequency (octave band) Hz							
	63	125	250	500	1000	2000	4000	8000
100	10	15	7	-1	-4	-11	-23	-31
125	10	13	6	0	-2	-8	-22	-31
160	9	9	2	2	-1	-6	-23	31
200	11	10	4	5	-6	-13	-28	-31
250	13	9	6	4	-7	-18	-32	-31
315	14	12	8	4	-10	-23	-33	-31
Size CDD+ALS	Mid-frequency (octave band) Hz							
	63	125	250	500	1000	2000	4000	8000
100	11	12	8	0	-5	-10	-16	-23
125	10	11	8	0	-5	-9	-18	-23
160	10	13	8	0	-5	-9	-20	-24
200	9	11	8	1	-5	-11	-21	-22
250	10	15	8	-1	-7	-14	-23	-24
315	9	15	7	1	-6	-14	-26	-27
Tol. ±	2	2	2	2	2	2	2	2

Sound attenuation ΔL(dB)

Table ΔL

Size CDD	Mid-frequency (octave band) Hz							
	63	125	250	500	1000	2000	4000	8000
100	22	15	11	17	4	3	2	1
125	21	14	9	5	3	2	1	0
160	20	13	8	4	3	1	1	0
200	18	11	6	3	2	1	0	0
250	17	10	5	2	1	1	0	0
315	17	8	4	1	1	0	0	0
Size CDD+ALS	Mid-frequency (octave band) Hz							
	63	125	250	500	1000	2000	4000	8000
100	18	14	13	16	26	16	10	11
125	20	16	9	17	23	16	11	13
160	20	14	10	17	19	12	10	12
200	16	11	8	16	18	12	11	11
250	18	8	8	16	17	12	12	13
315	13	6	7	19	14	10	10	13
Tol. ±	2	2	2	2	2	2	2	2

CDR – Supply air

Sound effect level L_w (dB)

Table K_{ok}

Size CDR	Mid-frequency (octave band) Hz							
	63	125	250	500	1000	2000	4000	8000
100	10	13	6	3	-4	-13	-28	-31
125	10	13	7	3	-5	-11	-29	-31
160	9	12	8	3	-5	-17	-33	31
200	11	13	8	2	-4	-16	-32	-31
250	13	16	9	0	-9	-22	-32	-31
315	14	14	8	1	-4	-14	-28	-31
Size CDD+ALS	Mid-frequency (octave band) Hz							
	63	125	250	500	1000	2000	4000	8000
100	11	15	8	-1	-5	-14	-17	-22
125	10	14	9	-2	-6	-9	-19	-22
160	10	15	8	-2	-5	-11	-20	-25
200	9	14	8	1	-3	-8	-18	-22
250	10	16	7	-2	-6	-12	-19	-22
315	9	15	6	-1	-4	-11	-21	-26
Tol. ±	2	2	2	2	2	2	2	2

Sound attenuation ΔL(dB)

Table ΔL

Size CDR	Mid-frequency (octave band) Hz							
	63	125	250	500	1000	2000	4000	8000
100	22	17	13	7	2	1	0	0
125	21	16	12	7	2	0	0	0
160	20	14	10	5	1	0	0	0
200	18	13	9	4	0	0	0	0
250	17	11	7	3	0	0	0	0
315	17	10	6	2	0	0	0	0
Size CDD+ALS	Mid-frequency (octave band) Hz							
	63	125	250	500	1000	2000	4000	8000
100	18	14	13	16	26	16	10	11
125	20	16	9	17	23	16	11	13
160	20	14	10	17	19	12	10	12
200	16	11	8	16	18	12	11	11
250	18	8	8	16	17	12	12	13
315	13	6	7	19	14	10	10	13
Tol. ±	2	2	2	2	2	2	2	2

Engineering graphs

CDD, CDR with and without ALS

- The graphs apply to a diffuser installed in a ceiling.
- The graphs must not be used for commissioning.
- The dB(A) values are for rooms with normal acoustic absorption of 4 dB.
- The dB(C) value is normally 6-9 dB higher than the dB(A) value.

CDD/CDR – Supply air

Air diffuser only

CDD 100, 125, 160

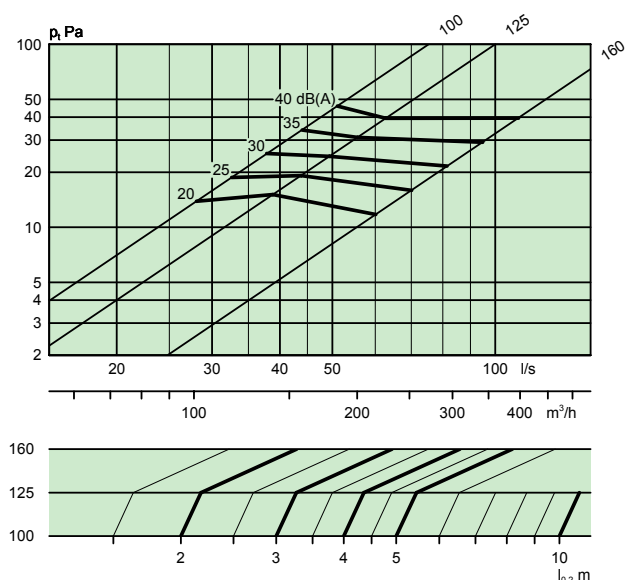

CDR 100, 125, 160

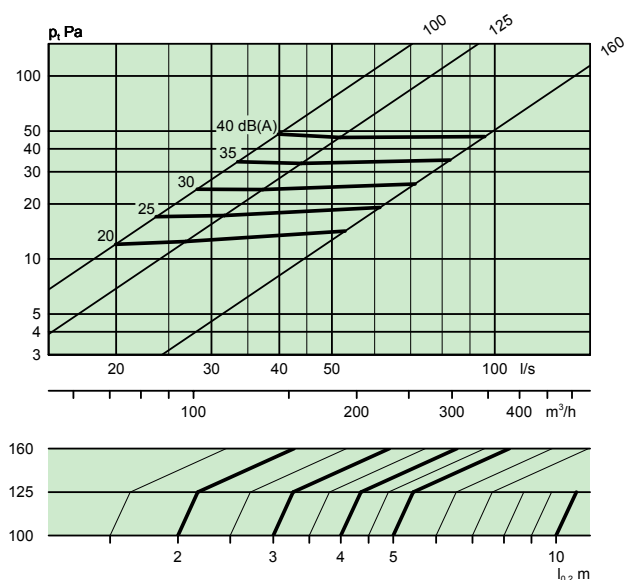

CDD 200, 250, 315

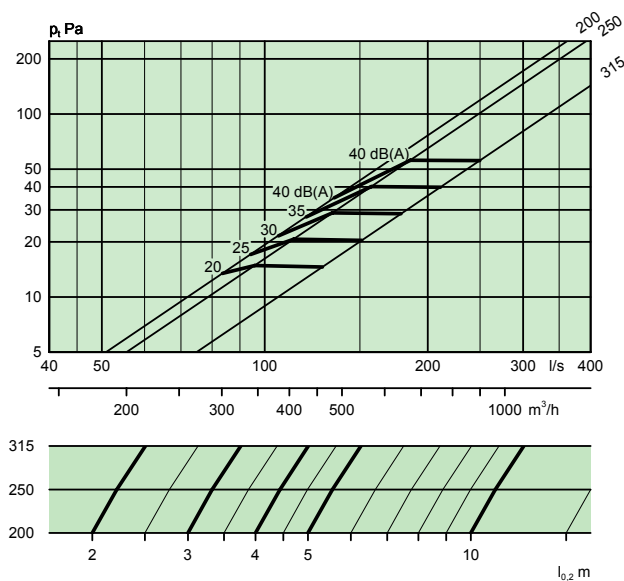

CDR 200, 250, 315

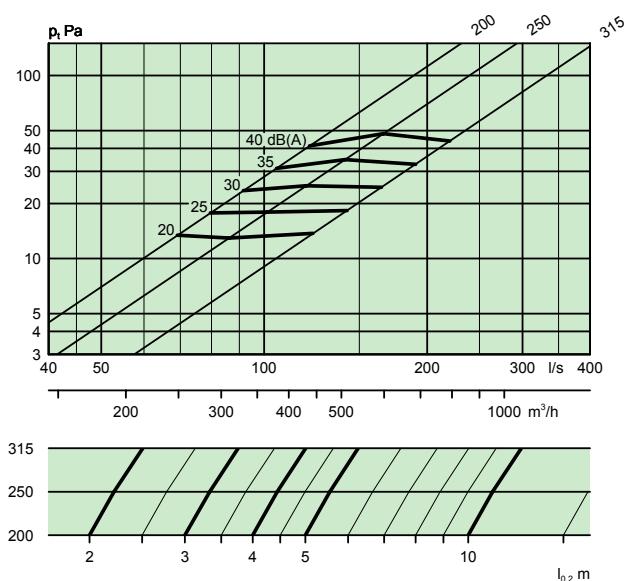

CDD/CDR

CDD with ALS – Supply air

Air diffuser with commissioning box

- ▽ = the minimum flow required to obtain sufficient commissioning pressure

CDD 100 + ALS 80-100

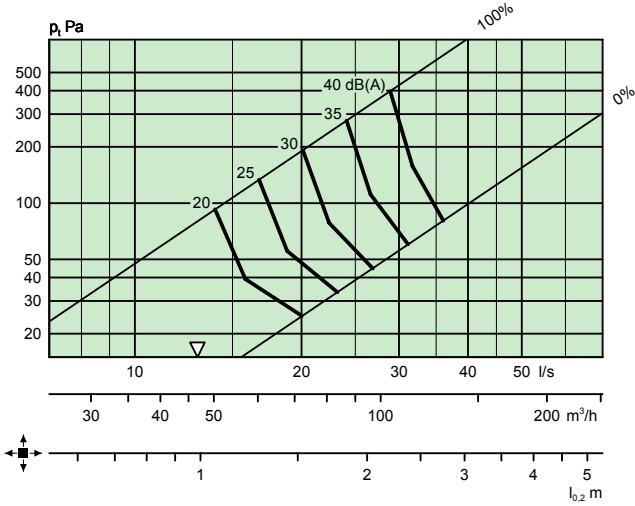

CDD 200 + ALS 160-200

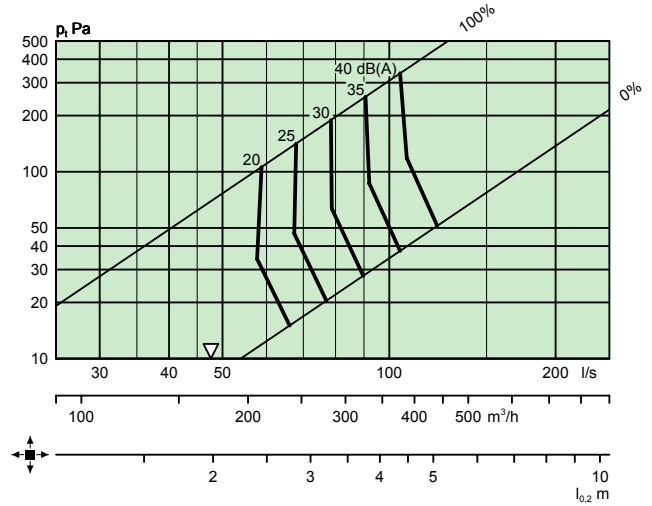

CDD 125 + ALS 100-125

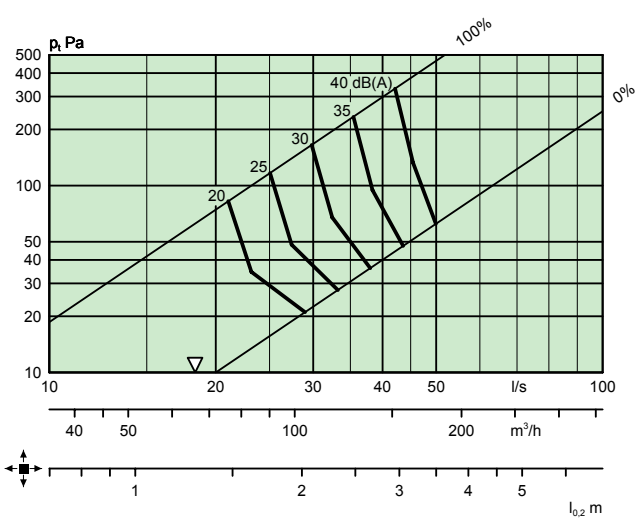

CDD 250 + ALS 200-250

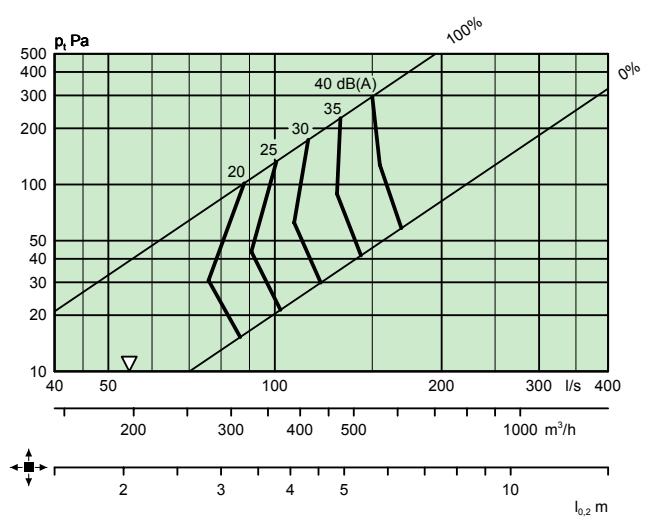

CDD 160 + ALS 125-160

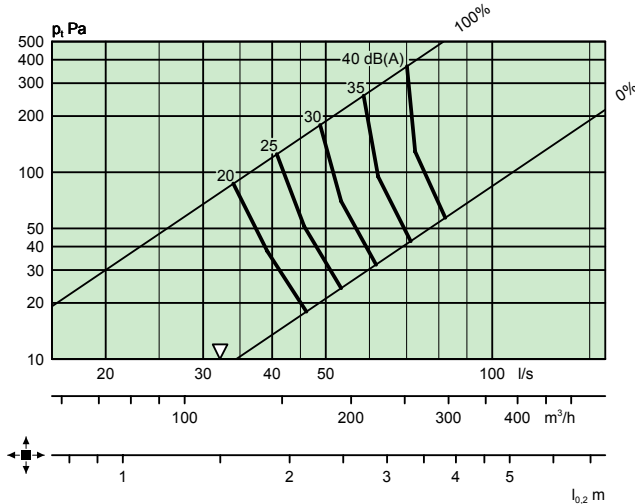

CDD 315 + ALS 250-315

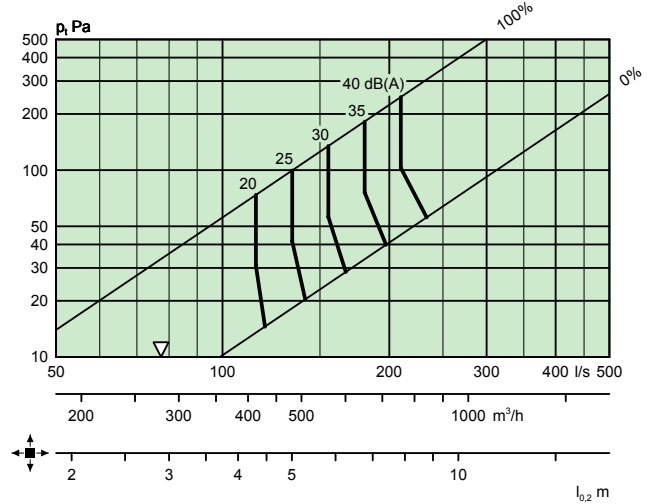

CDR with ALS – Supply air

Air diffuser with commissioning box

- ▽ = the minimum flow required to obtain sufficient commissioning pressure

CDR 100 + ALS 80-100

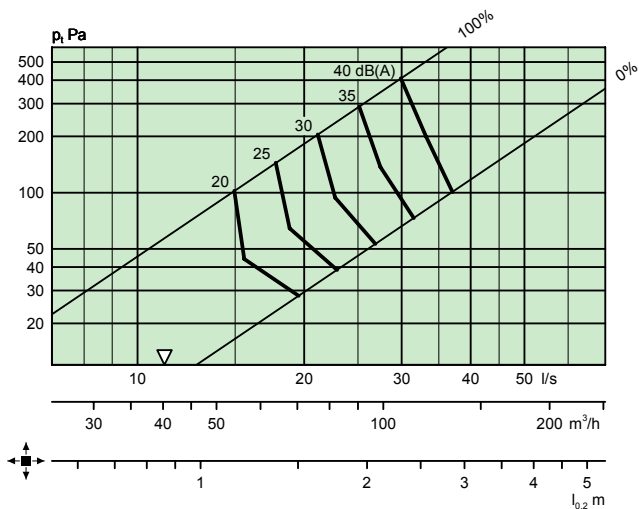

CDR 160 + ALS 125-160

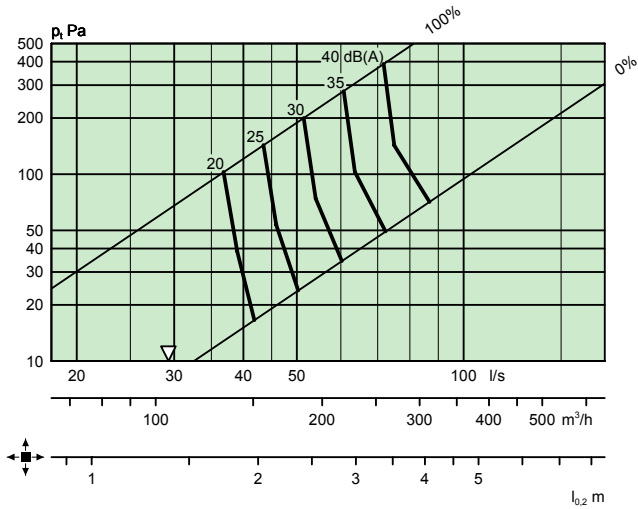

CDR 125 + ALS 100-125

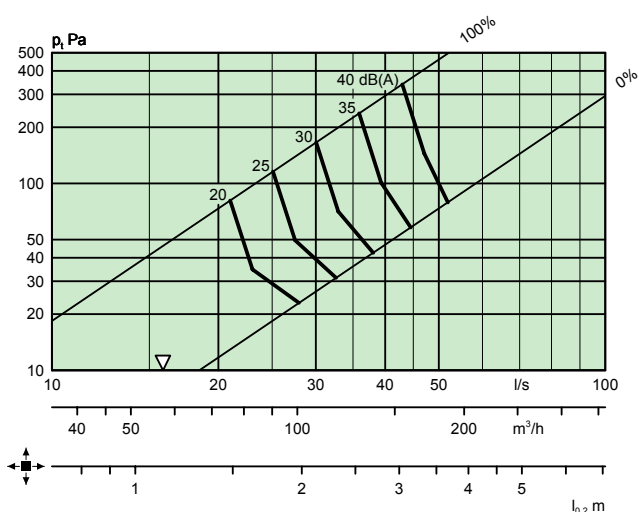

CDR 200 + ALS 160-200

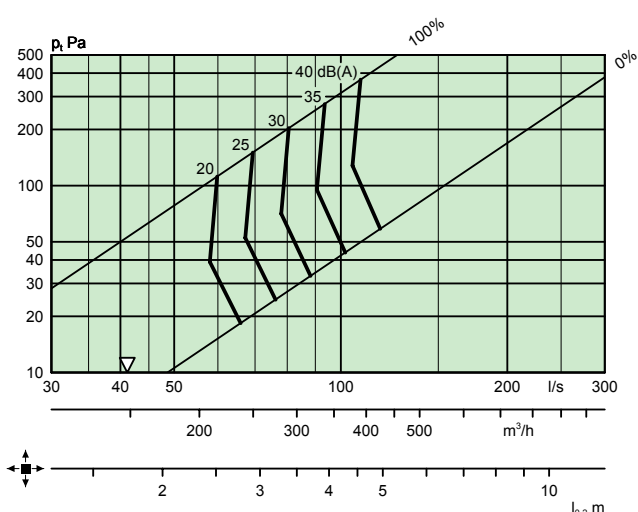

CDR 250 + ALS 200-250

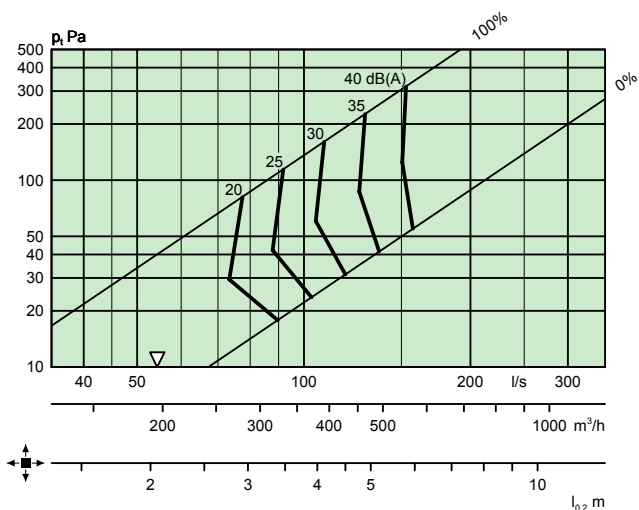

CDR 315 + ALS 250-315

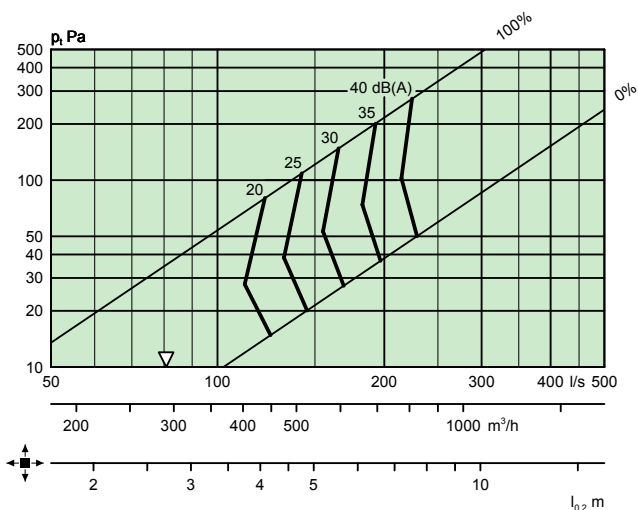

Dimensions and weight

CDD/CDR

Size	ØA	Ød	E	Slot opening	Weight, kg
100	192	99	36/46	20/30	0,6
125	228	124	36/46	20/30	0,8
160	304	159	46/56	30/40	1,3
200	380	199	46/56	30/40	1,8
250	456	249	50/60	30/40	2,5
315	568	314	50/60	30/40	3,7

Hole-making size = $\text{Ød} + 6 \text{ mm}$.

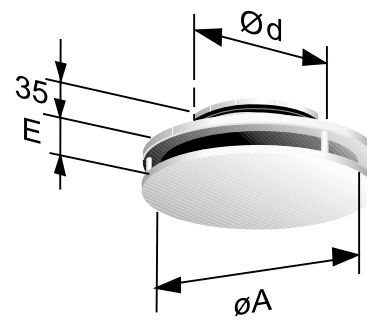

Figure 2. CDD/CDR.

CDD/CDR + ALS

Size	ØA	B	C	ØD	E
100	192	227	192	79	36/46
125	228	282	217	99	36/46
160	304	342	252	124	46/56
200	380	404	288	159	46/56
250	456	504	332	199	50/60
315	568	622	388	249	50/60

Size	F	G	H	K	Weight, kg
100	160	90	200	50	1,8
125	180	100	270	80	2,7
160	204	112	315	80	3,5
200	239	130	375	100	4,5
250	279	150	465	115	6,3
315	340	175	575	140	9,3

CL = Center line

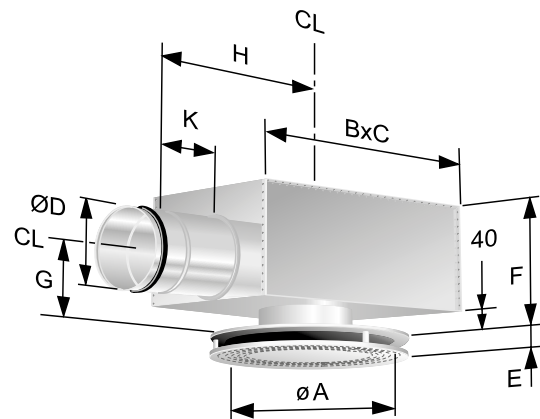

Figure 3. CDD/CDR + ALS. CL = Centerline.

Order key

Product

Circular ceiling terminal with perforated front plate for supply air CDD b -bbb

Version:

Nominal connection dimension, mm

Circular ceiling terminal with non-perforated front plate for supply air CDR c -bbb

Version:

Nominal connection dimension, mm

Standard range:

Size: 100
125
160
200
250
315

Accessories

Commissioning box ALS d -aaa - bbb

Version

For CDD/CDR	ALS
100:	80-100
125	100-125
160	125-160
200	160-200
250	200-250
315	250-315

Specification example

Swegons circular ceiling diffuser of the type CDD/CDR with commissioning box ALS, with the following functions:

- Adjustable air slot
- Cleanable
- Electrostatically powder-coated in white, RAL 9003/ NCS S 0500-N
- Cleanable commissioning box ALS with removable commissioning damper, lockable setting, measurement function with low method error and internal acoustic insulation with reinforced surface layer.

Size: CDDb + ALSd aaa - bbb xx units

Size: CDRc + ALSd aaa - bbb xx units