

SDW

Supply air diffuser for wall mounting in small premises



QUICK FACTS

- Supply air diffuser designed for small premises, for example, homes and offices
- Mounted on a wall close to the ceiling
- Removable front without tools
- The air flow is easily adjusted with the help of magnetic strips
- Measurement tapping on top for air flow measuring
- Standard colour White RAL 9003
 - 5 alternative standard colours
 - Other colours upon request

SDW Size	AIR FLOW - SOUND PRESSURE ROOM (L_{p10A} *)					
	25 dB(A)		30 dB(A)		35 dB(A)	
	l/s	m ³ /h	l/s	m ³ /h	l/s	m ³ /h
80	22	77	26	92	29	104
100	29	104	34	121	39	140
125	35	126	41	148	48	173

Applies to air diffuser without magnetic strip.

**) L_{p10A} = Sound pressure incl. A-filter with 4 dB room attenuation and 10 m² room absorption area.*

Technical description

Design

The function and design combined in Swegon's wall mounted supply air diffuser SDW. Ideal for small premises such as residential rooms and offices.

Other characteristics:

- The supply air diffuser consists of a back section with removable front plate and magnetic strips for flow regulation.
- Connection diameter in the sizes 80-125 mm.
- Adjusted by selecting the number of magnetic strips.
- Flow measurement occurs via k-factor and pressure measurement in the nipple.

Materials and surface treatment

The air diffuser is made of galvanised sheet steel where the interior and exterior surfaces are finished in our standard colour.

- Standard colour:
 - White semi-gloss, lustre 40, RAL 9003/NCS S 0500-N
- Alternative standard colours:
 - Silver gloss, lustre 80, RAL 9006
 - Grey aluminium gloss, lustre 80, RAL 9007
 - White semi-gloss, lustre 40, RAL 9010
 - Black semi-gloss, lustre 35, RAL 9005
 - Grey semi-gloss, lustre 30, RAL 7037
- Non-painted finish and other colours available on request.

Project planning

Project planning according to the sizing diagram. Mounted on a wall close to the ceiling. Data in the sizing diagram may need to be adjusted depending on the installation option. See the table on page 4.

Installation and commissioning

Air diffusers are designed for installation on circular ducts of the size Ø80-125 mm.

The air flow is adjusted by using 7 different throttled modes that are determined by how many magnetic strips are placed in the front. The number of magnetic strips gives different k-factors. The flow is determined through measuring the pressure in the nipple.

Maintenance

The air diffusers can be cleaned, if necessary, using luke-warm water with dishwashing detergent added or using a vacuum cleaner.

Environment

The Building Material Declaration is available for downloading at www.swegon.com.

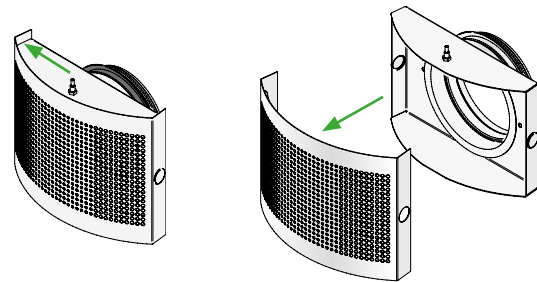
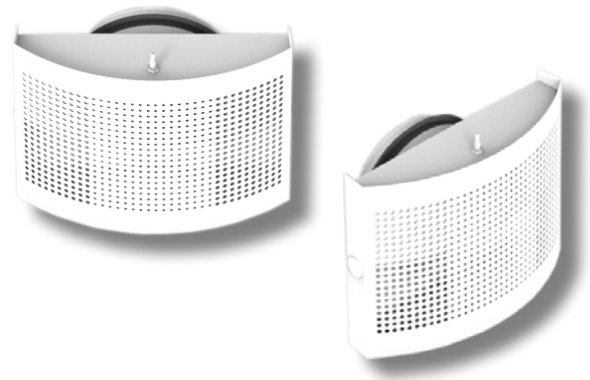

Figure 1. Removing the front, press the front outwards to the side and pull straight out.

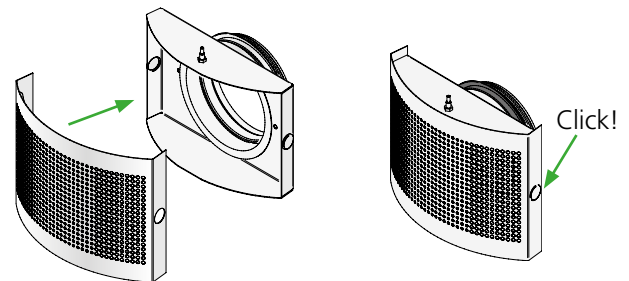

Figure 2. Assembling the front, press the front straight towards the wall plate unit it snaps into position.

Distribution pattern

- Generally, an air distribution pattern should be sought that cover as much of the room as possible.
- Suitable air distribution patterns depend on the placement of the supply air diffuser in relation to the room's design.

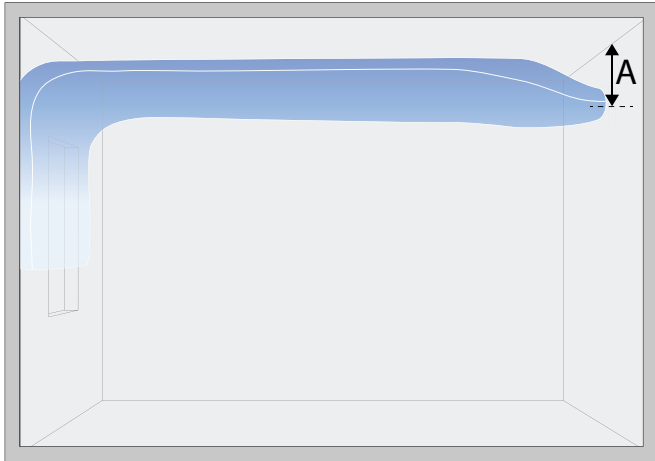

Figure 3. Distribution pattern A = Recommended measurement from the ceiling 100-300 mm measured from the centre of the diffuser.

Flow regulation

The air diffuser's flow can be regulated using magnetic strips that are attached on the inside. See figure 4 to 10 below. A maximum of 6 magnetic strips can be used.

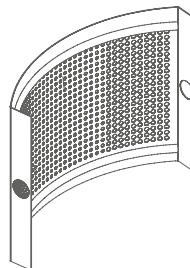

Figure 4.
No magnetic strips (R0).

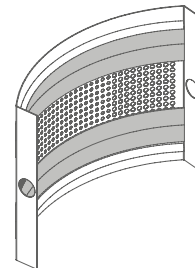

Figure 8.
4 Magnetic strips. Covers the 6 uppermost and 6 lowermost rows of holes (R4).

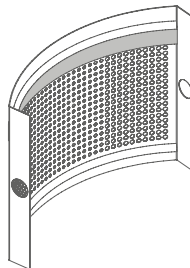

Figure 5.
1 Magnetic strip. Covers the 3 uppermost rows of holes (R1).

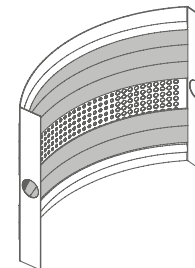

Figure 9.
5 Magnetic strips. 5 Rows in the middle are open (R5).

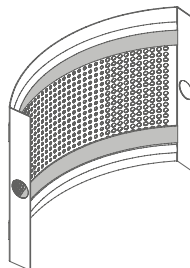

Figure 6.
2 Magnetic strips. Covers the 3 uppermost and 3 lowermost rows of holes (R2).

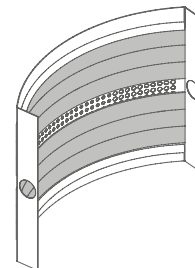

Figure 10.
6 Magnetic strips. 2 rows in the middle are open (R6).

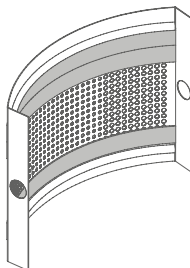

Figure 7.
3 Magnetic strips. Covers the 6 uppermost and 3 lowermost rows of holes (R3).

Sizing

- Sound pressure level dB(A) applies to rooms with 10 m² equivalent sound absorption area.
- Sound attenuation (ΔL) below is shown in the octave band. Orifice attenuation is included in the values.

Acoustic data

Sound power level L_w (dB)

Table K_{ok}

Size	Mid-frequency (octave band) [Hz]							
	63	125	250	500	1000	2000	4000	8000
80	-13	1	-3	-1	1	-4	-20	-28
100	-13	-1	-3	0	1	-3	-18	-27
125	-12	-3	-2	0	0	-2	-15	-26
Tol+/-	6	3	2	2	2	2	2	2

Attenuation ΔL (dB)

Table ΔL

Size	Mid-frequency (octave band) [Hz]							
	63	125	250	500	1000	2000	4000	8000
80	21	16	12	6	0	1	2	3
100	19	13	7	2	0	3	1	1
125	20	16	12	7	2	2	2	2
Tol+/-	6	3	2	2	2	2	2	2

L_w = Sound power level

L_{p10A} = Sound pressure level dB (A)

K_{ok} = Correction for producing the L_w value in the octave band

L_w = L_{p10A} + K_{OK} gives the frequency divided octave band

Sound increase for different installations

	Open rows of holes					
	Without magnetic strips		3 magnetic strips		6 magnetic strips	
X						
5D	+0 dB	+2 dB	+0 dB	+2 dB	+0 dB	+0 dB
2D	+2 dB	+4 dB	+2 dB	+4 dB	+0 dB	+0 dB
0D	+4 dB	+6 dB	+3 dB	+5 dB	+0 dB	+0 dB

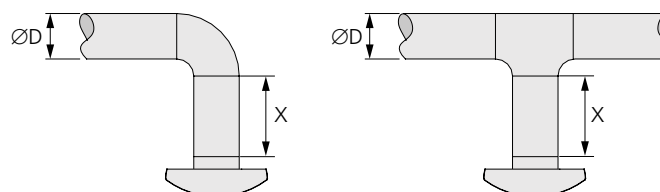

Sizing diagram

- Throw length is presented in the sizing diagram depending on the flow.
- Supply and air velocity in the occupied zone are shown for isothermal conditions (supply temperature = room temperature).
- The air distribution patterns are shown with Isovel 0.20 m/s. In the winter case and wishes of Isovel 0.15 m/s use correction factor 0.8. In the summer case and wishes of Isovel 0.25 m/s use correction factor 1.2.
- Recommended maximum under temperature is 5 K.
- Sound level, specified in dB(A) for rooms with normal acoustic absorption 4 dB (10 m² equivalent sound absorption area).
- Installation directly in an elbow or T-piece gives a 2-6 dB(A) sound increased, see the table on page 4.

SDW 100

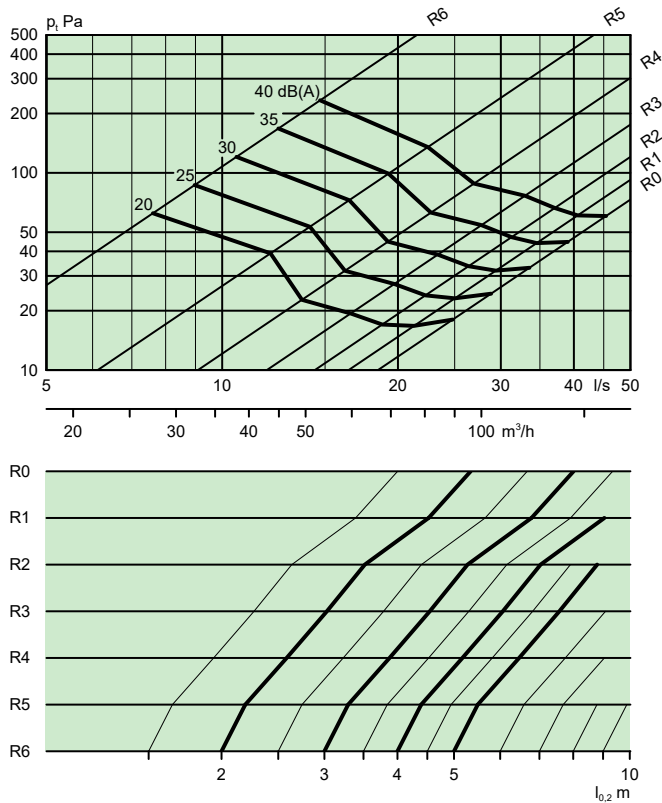

SDW 80

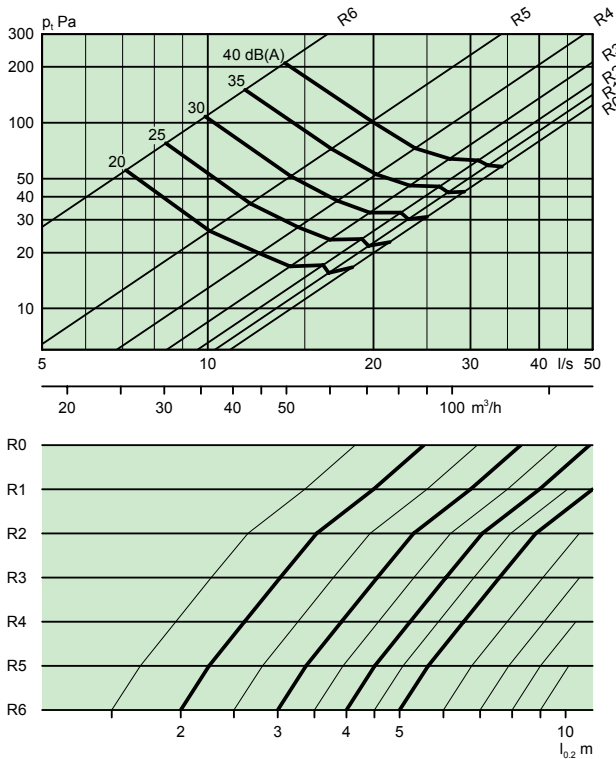

SDW 125

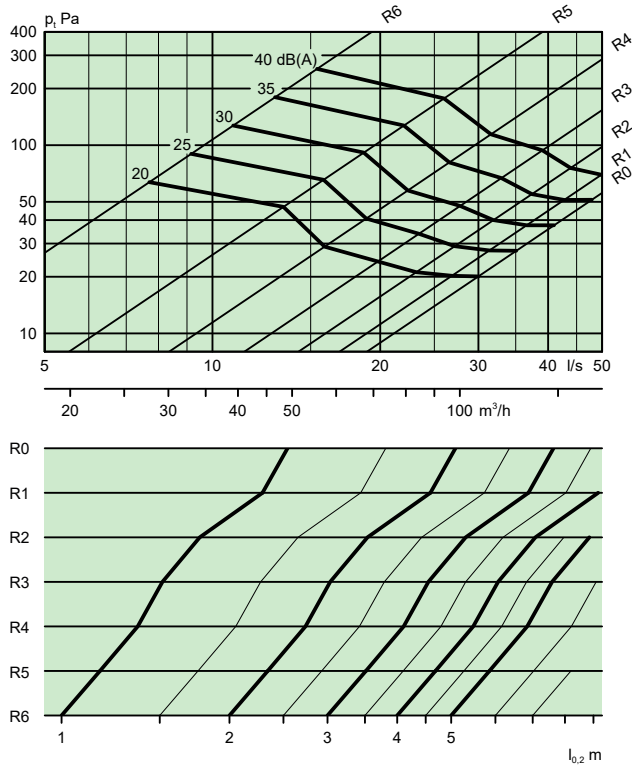

Dimensions and weights Specification

SDW

Size (Nominal dim.)	Dimensions (mm) ØD	Weight (g)
80	79	676
100	99	661
125	124	632

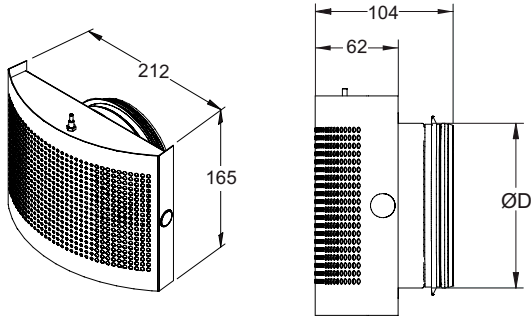

Figure 11. Dimensions, SDW

Product

Supply air diffuser wall SDW a -bbb

Version:

Size: 80, 100, 125

Specification text

Swegon's supply air diffuser for residential ventilation.

- Curved front
- Wall mounted
- Provision for commissioning and air flow measurement
- Available in various colours
- Powder coated white in RAL 9003/NCS S 0500-N as standard
- Easy access without tools for commissioning and cleaning

Examples:

Size SDWa-100 xx items