

# CKD

Circular Conical Ceiling Diffuser/Jet air diffuser for supply air



## QUICK FACTS

- Diffused or concentrated spread pattern
- Cone unit adjustable through 360°
- Possible to motor control the supply air angle  $\pm 25^\circ$
- Suitable for heating or cooling
- Can be used together with ALS commissioning box
- Standard colour White RAL 9003
  - 5 alternative standard colours
  - Other colours upon request

AIR FLOW - SOUND PRESSURE ROOM (Lp10A) *)							
CKD Size	30 dB(A)		35 dB(A)		40 dB(A)		
	l/s	m <sup>3</sup> /h	l/s	m <sup>3</sup> /h	l/s	m <sup>3</sup> /h	
200	58	209	65	234	72	259	
250	82	295	95	342	115	414	
315	160	575	180	648	210	756	
400	225	810	260	936	300	1080	
500	350	1260	400	1280	450	1620	
CKD Size	ALS Size	30 dB(A)		35 dB(A)		40 dB(A)	
		l/s	m <sup>3</sup> /h	l/s	m <sup>3</sup> /h	l/s	m <sup>3</sup> /h
200	160-200	58	209	70	252	85	306
250	200-250	85	306	100	360	125	450
315	250-315	130	468	160	575	190	684
400	315-400	210	756	245	882	290	1044

Data applies to the combination of CKD + ALS commissioning box at total pressure drop of 50 Pa and diffused spread pattern.

\*)  $L_{p10A}$  = Sound pressure incl. A-filter with 4 dB room attenuation and 10 m<sup>2</sup> room absorption area.

# Contents

<b>Technical description .....</b>	<b>3</b>
Design .....	3
Materials and surface treatment.....	3
Accessories .....	3
Planning .....	3
Installation.....	3
Commissioning with ALS .....	3
Maintenance.....	3
Environment .....	3
<b>Sizing .....</b>	<b>5</b>
Engineering graphs - CKD with ALS - Supply air .....	7
<b>Dimensions and weight.....</b>	<b>9</b>
<b>Order key.....</b>	<b>10</b>
<b>Specification example .....</b>	<b>10</b>

# Technical description

## Design

The diffuser consists of an outer cylinder with a rubber seal on the connection spigot and an aerodynamically shaped multi-cone assembly, which enable either a concentrated or diffused spread pattern. The multi-cone assembly is suspended in the outer cylinder and can be rotated through 360°. One end of the multi-cone assembly has straight pipes, which enable the supply air to enter the room with a higher impulse and consequently, reach longer throws. This is called a concentrated spread pattern. CKD is also available in a motorised version.

## Materials and surface treatment

The outer cylinder is manufactured in galvanised sheet steel. The cone assembly is manufactured in sheet steel. The outer cylinder is unpainted whereas the cone assembly is painted on all surfaces and interior.

- Standard colour:
  - White semi-gloss, lustre 40, RAL 9003/NCS S 0500-N
- Alternative standard colours:
  - Silver gloss, lustre 80, RAL 9006
  - Grey aluminium gloss, lustre 80, RAL 9007
  - Blanc semi-brillant, lustre 40, RAL 9010
  - Black semi-gloss, lustre 35, RAL 9005
  - Grey semi-gloss, lustre 30, RAL 7037
- Non-painted finish and other colours available on request.

## Accessories

### Commissioning box:

ALS is manufactured in galvanized sheet steel. It includes a removable commissioning damper, fixed measuring unit and acoustic lining material with a reinforced surface layer, to Fire Resistance Class B-s1,d0 according to EN ISO 11925-2.

### Controller

VHC – controller for resetting motor controlled diffusers with variable spread patterns for cooling and heating. The controller resets motor controlled diffusers intended both for cooling and heating with supply air. The controlling parameter is the temperature difference between supply air and room air. See separate product sheet for VHC.

## Planning

The inner cone assembly can be rotated through 360° to adjust from diffused to concentrated spread pattern. The diffuser can be supplied with an electric motor which can adjust the angle of supply air  $\pm 25^\circ$ . Manually controlled via rheostat or push-button etc.



## Installation

The inlet spigot of the diffuser is fixed in the connection duct using blind rivets. When used in conjunction with the ALS commissioning box, the spigot between the diffuser and the commissioning box ALS can be extended using ordinary circular duct up to 500 mm length without having to extend the measuring tube or damper cords. See Figure 1.

## Commissioning with ALS

Commissioning must be carried out with the diffuser section in place. The measuring tubes and damper cords are pulled out of the diffuser through the slot. The damper setting can be locked. The k-factor is displayed on the product label and is also indicated in the relevant k-factor guide which can be downloaded at [www.swegon.com](http://www.swegon.com).

## Maintenance

The diffuser can be cleaned when necessary using luke warm water and detergent. The duct system can be accessed without the use of tools. The cone assembly is removed by removing the bolt on the outside of the cylinder. If the ALS commissioning box is used, the distribution plate is hinged aside and the damper unit twisted from its mounting with a simple hand movement.

## Environment

The Declaration of construction materials is available at [www.swegon.com](http://www.swegon.com).

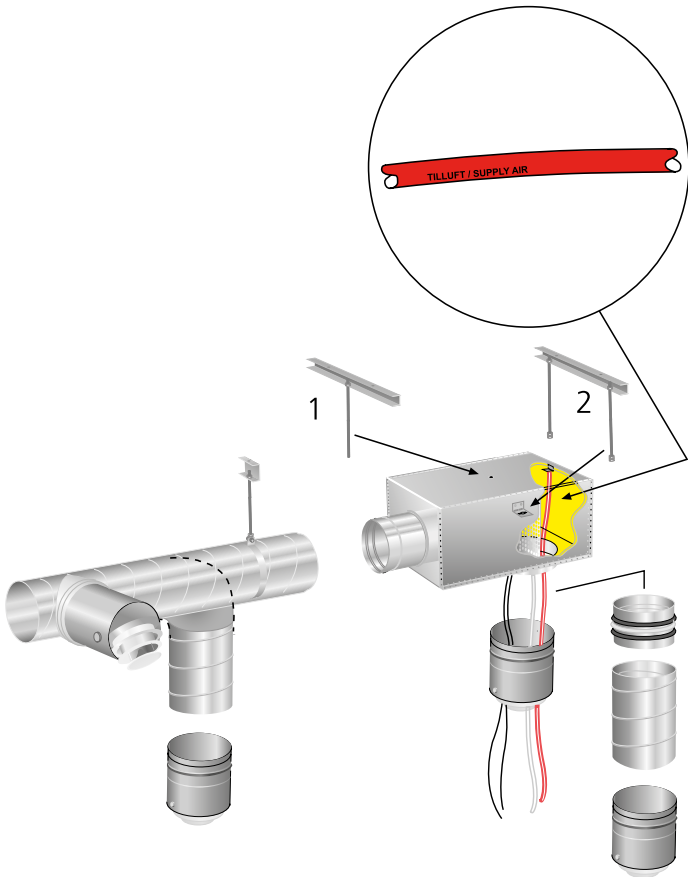

Figure 1. Installation.

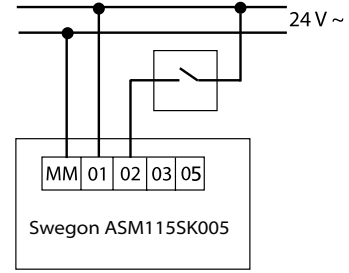

Figure 2. Wiring diagram for CKD 2 - Actuator with 2-point control. Change-over switch not included.

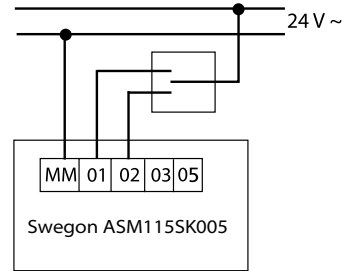

Figure 3. Wiring diagram for CKD 2 - Actuator with 3-point control. Change-over switch not included.

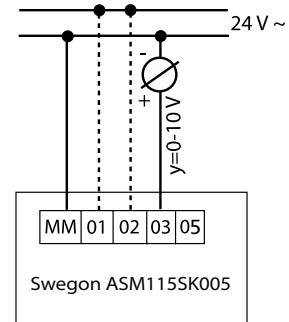

Figure 4. Wiring diagram for CKD 2 - Actuator with 0-10 V control. Potentiometer not included.

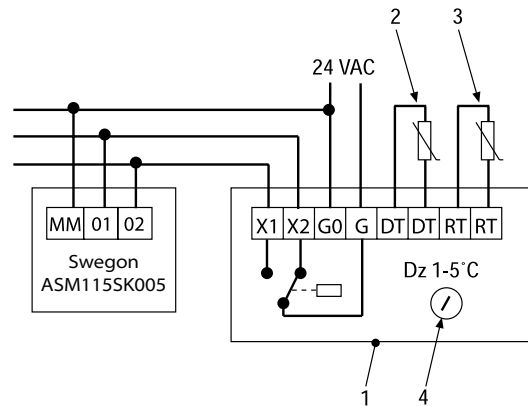

Figure 5. The wiring diagram shows the connections with the Swegon damper motor against the supply air diffuser.

- Key to Figure 5.
- 1 = VHC controller
  - 2 = Duct temperature sensor (DT)
  - 3 = Room temperature sensor (RT)
  - 4 = Setting the switch-over temperature

# Sizing

- Sound pressure level dB(A) applies to rooms with 10 m<sup>2</sup> equivalent sound absorption area.
- Sound attenuation (ΔL) below is shown in the octave band. Orifice attenuation is included in the values.
- The throw l<sub>0,2</sub> is measured under isothermal flow conditions.
- The maximum recommended under-temperature is 10 K.
- Diffused spread pattern: the cone unit turned with the aerodynamic cones facing into the room.
- Concentrated spread pattern: the cone unit turned with the straight pipes facing into the room.
- For calculating the width of the air stream, air velocities in the occupied zone or sound levels in rooms with other dimensions, please refer to our web calculation softwares available for download at [www.swegon.com](http://www.swegon.com).

L<sub>w</sub> = Sound power level

L<sub>p10A</sub> = Sound pressure level dB (A)

K<sub>ok</sub> = Correction for producing the L<sub>w</sub> value in the octave band

L<sub>w</sub> = L<sub>p10A</sub> + K<sub>OK</sub> gives the frequency divided octave band

## Sound data - Supply air

### Sound power level L<sub>w</sub>(dB)

**Table K<sub>OK</sub> for concentrated spread pattern**

Size CKD	Mid-frequency (octave band) Hz							
	63	125	250	500	1000	2000	4000	8000
200	1	3	-2	-3	1	-5	-10	-7
250	3	1	-4	-3	2	-11	-19	-14
315	5	2	-1	1	0	-9	-19	-14
400	5	2	1	4	-3	-8	-11	-10
500	5	2	1	5	0	-10	-12	-11
Size CKD + ALS	Mid-frequency (octave band) Hz							
	63	125	250	500	1000	2000	4000	8000
200	13	11	6	0	0	-9	-22	-27
250	12	10	3	0	2	-12	-24	-24
315	14	11	4	3	-1	-11	-27	-30
400	13	9	5	4	-2	-13	-25	-29
Tol. ±	2	2	2	2	2	2	2	2

### Sound attenuation ΔL(dB)

**Table ΔL**

Size CKD	Mid-frequency (octave band) Hz							
	63	125	250	500	1000	2000	4000	8000
200	19	13	10	4	0	0	0	0
250	22	11	7	3	0	0	0	0
315	20	10	6	2	0	0	0	0
400	16	9	5	1	0	0	0	0
500	15	7	3	1	0	0	0	0
Size CKD + ALS	Mid-frequency (octave band) Hz							
	63	125	250	500	1000	2000	4000	8000
200	15	11	8	16	18	12	11	11
250	14	8	8	16	17	12	12	13
315	13	6	7	19	14	10	10	13
400	13	5	8	14	11	10	11	12
Tol. ±	2	2	2	2	2	2	2	2

### Sound power level L<sub>w</sub>(dB)

**Table K<sub>OK</sub> for diffused spread pattern**

Size CKD	Mid-frequency (octave band) Hz							
	63	125	250	500	1000	2000	4000	8000
200	2	4	-1	-2	1	-5	-12	-9
250	2	0	-1	2	-1	-10	-15	-15
315	5	2	0	1	-1	-8	-13	-11
400	6	3	1	3	-1	-7	-9	-10
500	6	3	0	2	0	-7	-8	-11
Size CKD + ALS	Mid-frequency (octave band) Hz							
	63	125	250	500	1000	2000	4000	8000
200	12	9	3	0	1	-10	-23	-26
250	10	8	1	2	1	-12	-24	-23
315	12	8	1	3	0	-13	-30	-31
400	10	6	1	5	-3	-17	-30	-30
Tol. ±	2	2	2	2	2	2	2	2

### Sound attenuation ΔL(dB)

**Table ΔL**

Size CKD	Mid-frequency (octave band) Hz							
	63	125	250	500	1000	2000	4000	8000
200	19	13	10	4	0	0	0	0
250	22	11	7	3	0	0	0	0
315	20	10	6	2	0	0	0	0
400	16	9	5	1	0	0	0	0
500	15	7	3	1	0	0	0	0
Size CKD + ALS	Mid-frequency (octave band) Hz							
	63	125	250	500	1000	2000	4000	8000
200	15	11	8	16	18	12	11	11
250	14	8	8	16	17	12	12	13
315	13	6	7	19	14	10	10	13
400	13	5	8	14	11	10	11	12
Tol. ±	2	2	2	2	2	2	2	2

## Engineering graphs - Supply air

### Air flow - Pressure drop - Sound level - Throw

- The diagrams illustrate data for a freely suspended CKD.
- The graphs are not to be used for commissioning.
- The dB(A) values are for rooms with normal acoustic absorption of 4 dB.
- The dB(C) value is normally 6-9 dB higher than the dB(A) value.
- The graphs illustrate data for a horizontal spread pattern. For a vertical spread pattern please refer to the selection Software ProAir web which is available for download at [www.swegon.com](http://www.swegon.com).

**CKD 200, 250, 315 - Horizontal diffused**

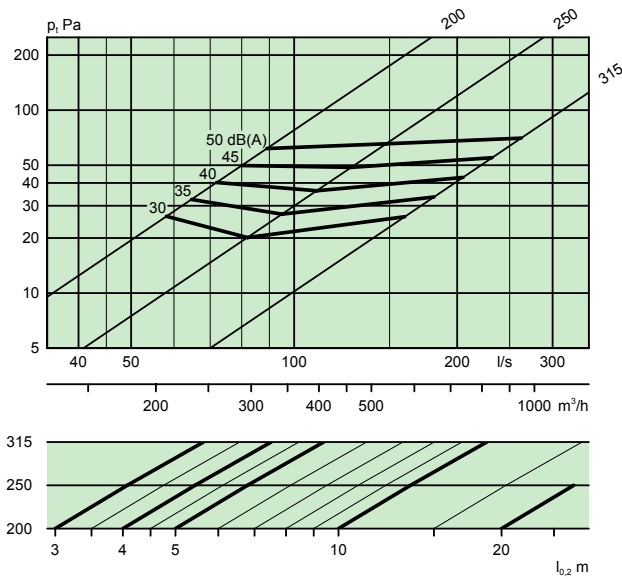

**CKD 400, 500 - Horizontal diffused**

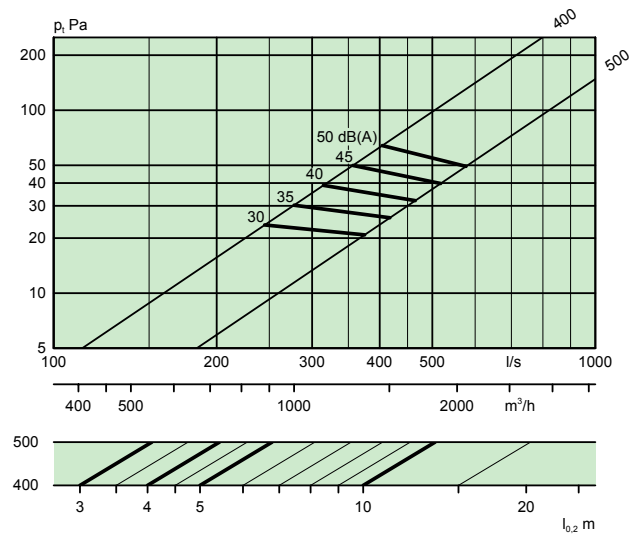

**CKD 200, 250, 315 - Horizontal concentrated**

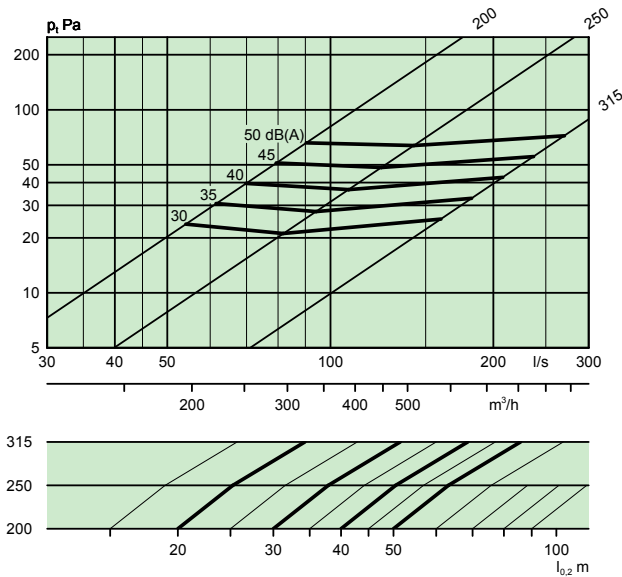

**CKD 400, 500 - Horizontal concentrated**

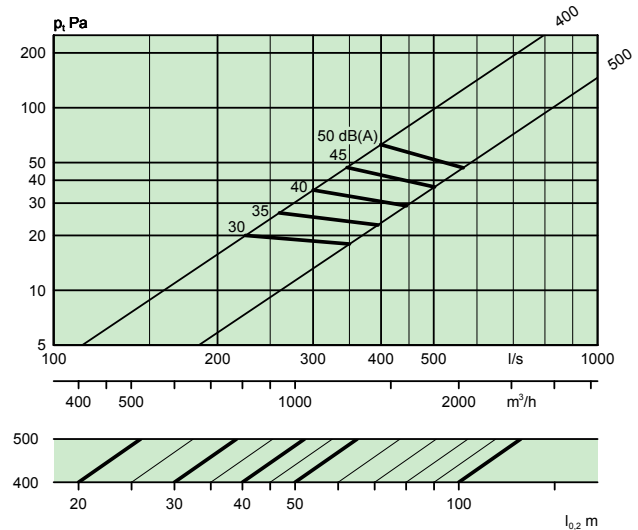

## Engineering graphs - CKD with ALS - Supply air

### Air flow - Pressure drop - Sound level - Throw

- The graphs are not to be used for commissioning.
- $V$  = min. airflow to obtain sufficient commissioning pressure.
- The dB(A) values are for rooms with normal acoustic absorption of 4 dB.
- The dB(C) value is normally 6-9 dB higher than the dB(A) value.
- The graphs illustrate data for a horizontal spread pattern. For a vertical spread pattern please refer to the selection software ProAir web which is available for download at [www.swegon.com](http://www.swegon.com).

**CKD 1-200 + ALS 160-200, diff. spread pattern**

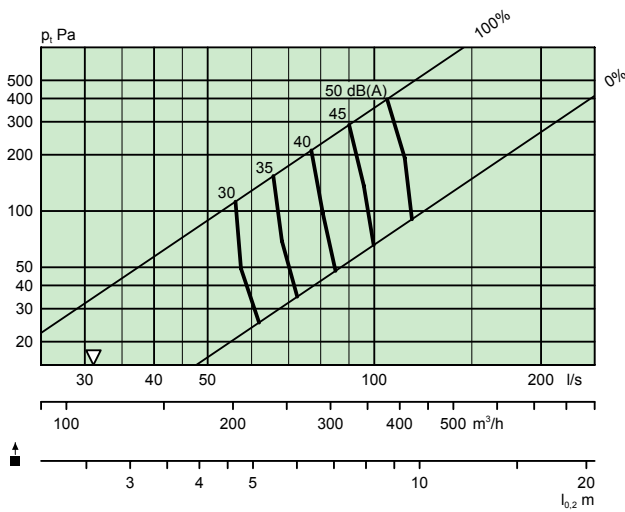

**CKD 1-250 + ALS 200-250, diff. spread pattern**

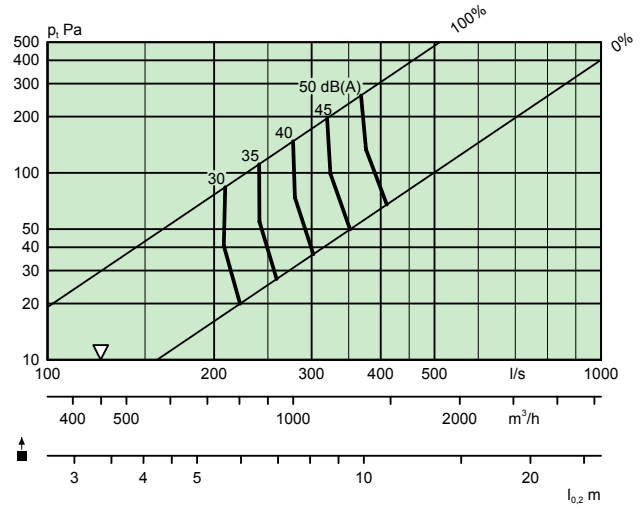

**CKD 1-315 + ALS 250-315, diff. spread pattern**

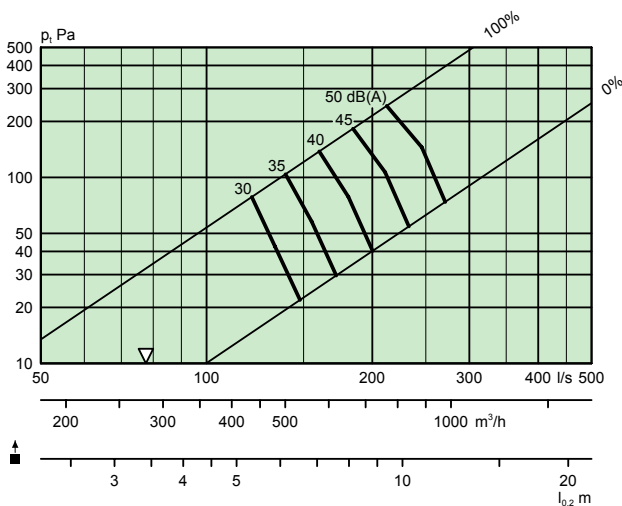

**CKD 1-400 + ALS 315-400, diff. spread pattern**

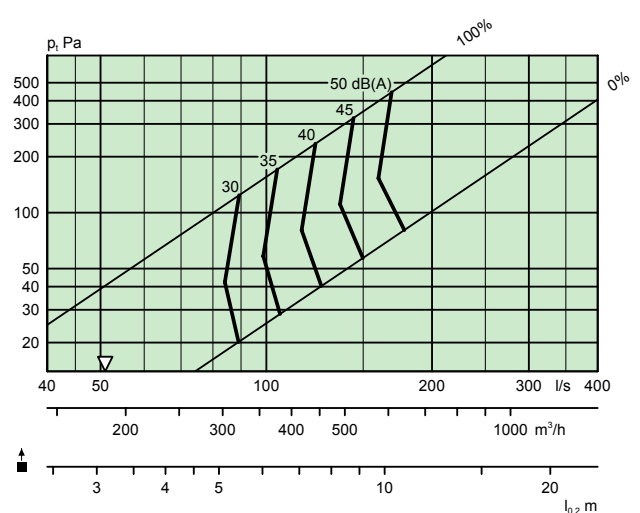

CKD 1-200 + ALS 160-200, Conc. spread pattern

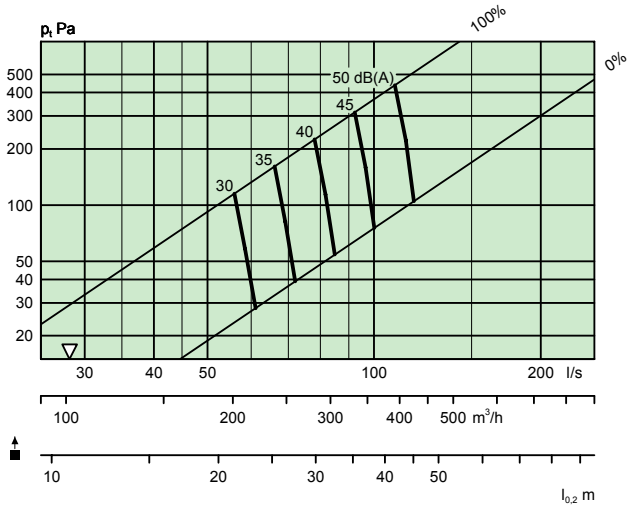

CKD 1-315 + ALS 250-315, Conc. spread pattern

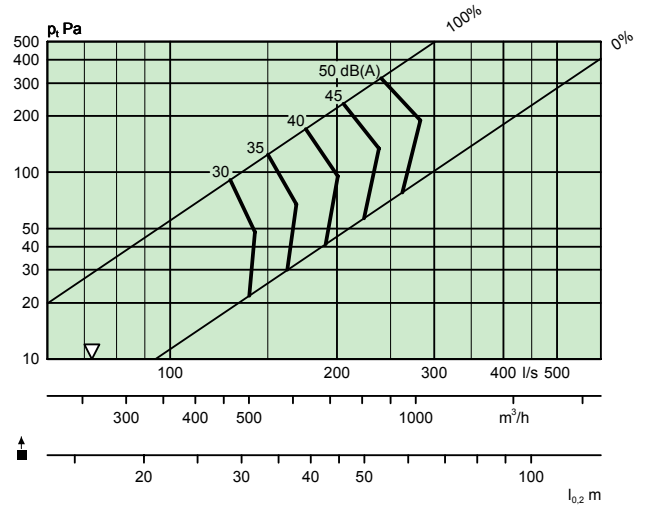

CKD 1-250 + ALS 200-250, Conc. spread pattern

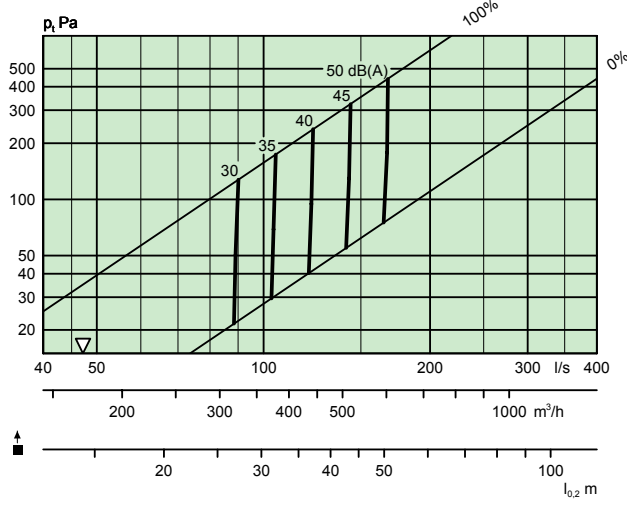

CKD 1-400 + ALS 315-400, Conc. spread pattern

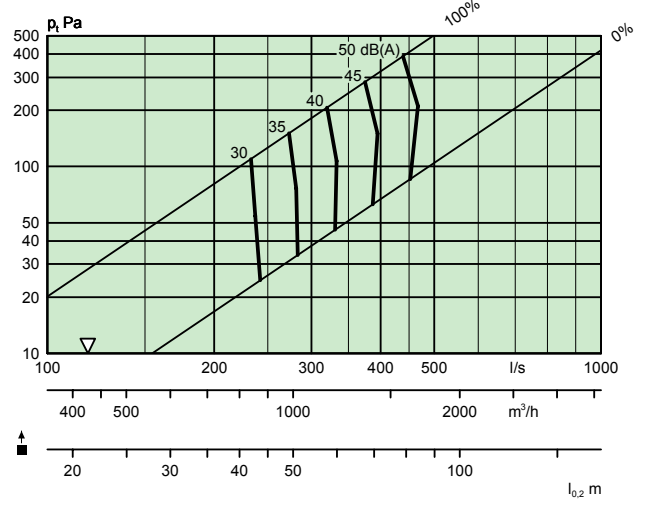



# Dimensions and weight

## CKD 1 + ALS

Size	B	C	ØD	Ød	E	F
200	404	288	159	200	80	239
250	504	332	199	250	105	279
315	622	388	249	315	140	340
400	767	488	314	400	190	400

Size	G	H	K	Weight, kg
200	130	375	100	6.6
250	150	465	115	9.2
315	175	575	140	13.0
400	212	712	175	15.3

## CKD 1 and CKD 2

Size	I	J	Ød	Weight, kg
200	162	162	199	2.5
250	204	204	249	3.5
315	262	262	314	4.5
400	342	337	399	4.5
500	450	440	499	9,8

CL = Center line

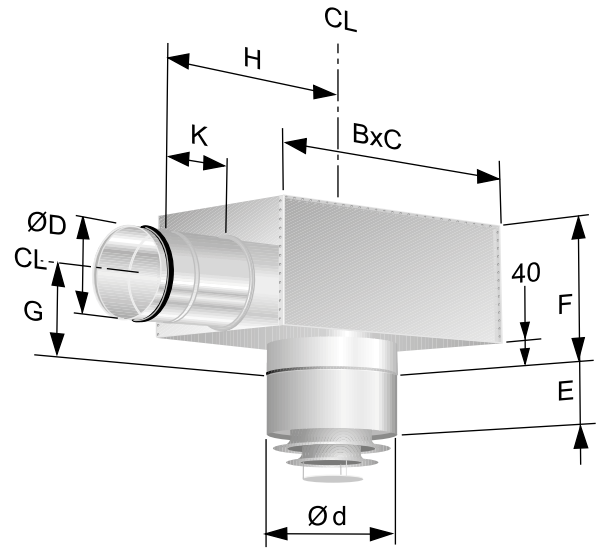

Figure 7. CKD 1 with ALS.

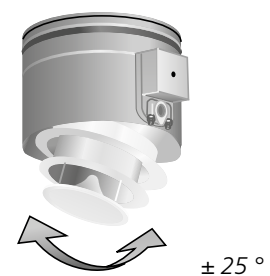
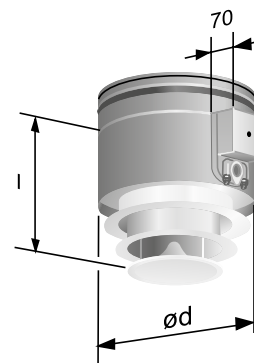
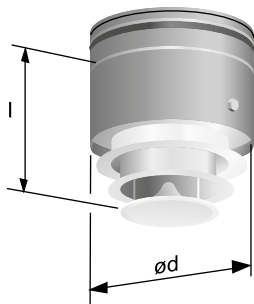

Figure 6. CKD 1.

Figure 8. CKD 2 with electric motor.

## Order key

### Product

Cone jet diffuser CKD a -a -bb  
 Version:  
 Adjustment:  
 1 = Without motor  
 2 = With motor  
 Size: 200, 250, 315, 400, 500

### Accessories

Commissioning box ALS d -aaa -bbb  
 Version:  
 Size:  
 Controller VHC a  
 Version:

## Specification example

Swegons multi-cone jet diffuser of type CKD with commissioning box ALS having the following functions:

- Adjustable throw and spread patterns
- Powder coated in white, RAL 9003/NCS S 0500-N
- Cleanable commissioning box ALS with removable commissioning damper including a lockable adjustment, measurement function with low method error and internal acoustic lining with reinforced surface layer

Size: CKDa a - bbb with ALSd aaa-bbb xx items