

CDH/CLH

CleanZone – Ceiling diffuser with Hepa-filter for supply air in clean rooms



QUICK FACTS

- Rectangular or circular duct connection
- Size CDH/CLH 60 designed for suspended ceiling systems 600x600 with visible T-bars
- Equipped with Hepa-filter H14 with gel seal (CLH), or dry seal (CDH)
- Painted inside for easy cleaning
- Measurement outlet for dip test and pressure above filter
- Perforated or nozzle diffuser face
- Standard colour White RAL 9003
 - 5 alternative standard colours
 - Other colours upon request

AIRFLOW - PRESSURE DROP - SOUND LEVEL*					
CDH/CLH Size		Velocity over the filter at 0,45 m/s			
		Air flow		Pressure drop	Sound level
	Type	l/s	m ³ /h	Δp Pa	L _A dB(A)
33-160-1	Perf.	41	148	150	<15
	Nozzles	41	148	170	<20
60-315-1	Per.	116	418	40	<15
	Nozzles	116	418	55	<25
66-315-1	Perf.	167	601	145	<15
	Nozzles	167	601	170	35

*Upper limit for the air flow is equivalent to **0.58 m/s** across the filter's nominal gross area, see sizing diagram. Data applies to 4-way horizontal spread pattern.

Content

Technical description	3
Design	3
Materials and surface treatment.....	3
Accessories	3
Planning	3
Installation	3
Commissioning	3
Maintenance	3
Environment	3
Sizing	5
Sound data	5
Engineering graphs	5
Dimensions and weights	8
Nozzle settings	9
Order key	10
Specification example	10

Technical description

Design

The CDH/CLH is a supply air diffuser for ceiling installation, equipped with an Hepa-filter. It consists primarily of two parts: the filter box and the diffuser unit. Circular or rectangular duct connection to the filter box. The filter is available in two versions: with a gel seal (CLH) or with a rubber seal, known as a dry seal (CDH).

Materials and surface treatment

The unit is manufactured in sheet steel and painted on the exterior and interior.

- Standard colour:
 - White semi-gloss, lustre 40, RAL 9003/NCS S 0500-N
- Alternative standard colours:
 - Silver gloss, lustre 80, RAL 9006
 - Grey aluminium gloss, lustre 80, RAL 9007
 - Blanc semi-brillant, lustre 40, RAL 9010
 - Black semi-gloss, lustre 35, RAL 9005
 - Grey semi-gloss, lustre 30, RAL 7037
- Other colours available on request.

Accessories

Filter:

Hepa-filter H14 with gel seal or rubber gel.

Separation efficiency: 99.995% @ MMPS, EN 1822 (MPPS= most penetrating partical size).

Filter dimensions: 610 x 610, 508 x 508 mm and 305 x 305 mm.

Planning

The air velocity over the filter must not exceed 0.58 m/s (nom. flow 0.45 +30%), calculated over the gross area of the filter. This limit is set to ensure the separation efficiency of the filter, i.e. H14 class.

Installation

The diffuser is equipped with four steel brackets for suspending the unit from the ceiling. It is very important that the diffuser is installed exactly horizontally ($\pm 1,0$ mm) to ensure the function of the gel-seal. The rectangular duct connection is of a flange design. Subsequent to installation, the duct connections must be sealed on the outside with jointing compound. When the diffuser is installed in a ceiling the covering flange must be sealed in place in the suspended ceiling. See figure 1. Mounting of filters, see Figure 2 and Figure 3.

Commissioning

The product lacks a commissioning damper. It is recommended that the ducts before the diffuser are provided with some sort of commissioning.

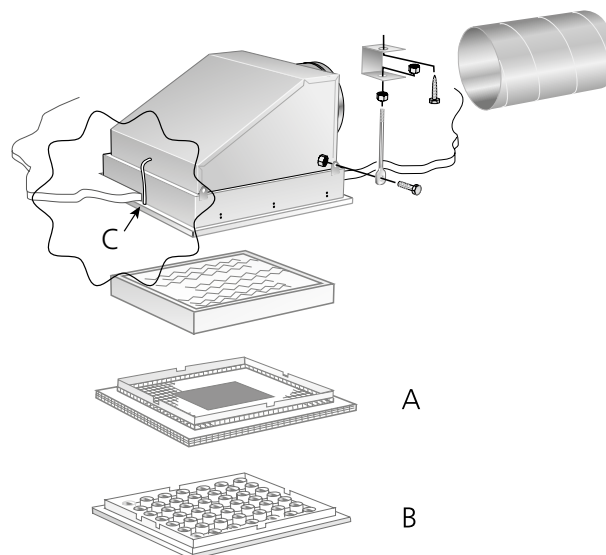

Figure 1. Mounting.
 A = Perforated diffuser face.
 B = Diffuser face with nozzles.
 C = Measurement tapping for DOP test^{*)} and pressure measurement across the filter.

^{*)} Test of leakage on the product and check of the filter's particle separation efficiency with DOP testing.

Maintenance

- The diffuser can be cleaned, if necessary, using lukewarm water with dishwashing detergent or with alcohol solution.
- The filter is replaced by unsnapping the spring-mounted diffuser face. Release the filter fasteners and remove the filter.
- Recommended final residual pressure: 2x initial pressure drop for the product with filter.
- The filter may be subjected to a maximum pressure drop of 500 Pa.
 NOTE! The degree of separation is impaired at a high flow/pressure, see the diagram for the recommended working range.

Environment

The Declaration of construction materials is available at www.swegon.com.

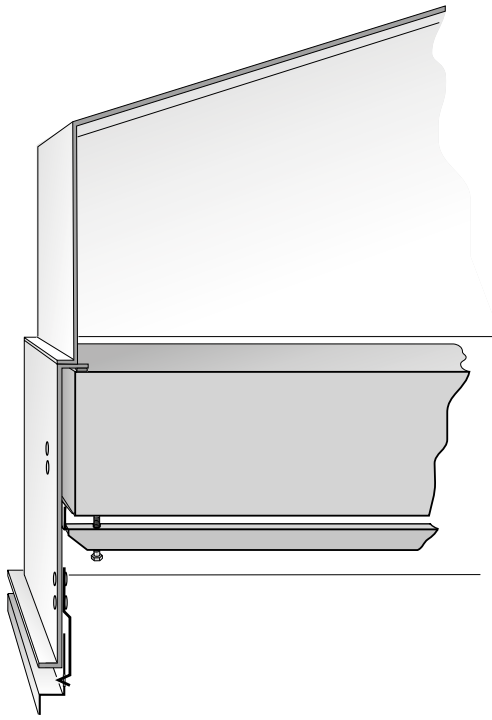

Figure 2. Mounting of filter CDH.

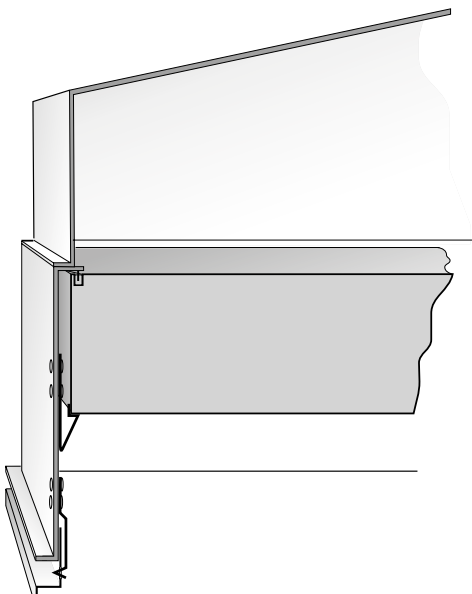

Figure 3. Mounting of filter CLH.

Sizing

- Sound pressure level dB(A) applies to rooms with 10 m² equivalent sound absorption area.
- Sound attenuation (ΔL) below is shown in the octave band. Orifice attenuation is included in the values.
- Throw I_{0,2} is measured with isothermal air supply.

L_w = Sound power level

L_{p10A} = Sound pressure level dB (A)

K_{ok} = Correction for producing the L_w value in the octave band

L_w = L_{p10A} + K_{OK} gives the frequency divided octave band

Sound data

Sound power level L_w(dB)

Table K_{OK}

Size	Mid-frequency (octave band) Hz							
	63	125	250	500	1000	2000	4000	8000
33-160-1-1	2	0	-1	0	1	-4	-12	-16
33-160-1-2	1	4	8	-3	-2	-13	-19	-17
33-300-100-2-1	2	-4	-1	-2	0	-2	-7	-8
33-300-100-2-2	-6	5	8	2	-2	-12	-17	-17
60-315-1-1	-10	-3	-4	-1	2	-5	-18	-28
60-315-1-2	-2	7	5	4	-1	-14	-25	-28
60-500-100-2-1	-3	-3	0	3	-1	-5	-8	-18
60-500-100-2-2	-8	8	7	3	-3	-10	-15	-26
66-315-1-1	1	0	0	1	0	-5	-8	-10
66-315-1-2	4	8	7	3	-3	-15	-19	-15
66-600-100-2-1	-2	-1	-1	1	0	-5	-8	-8
66-600-100-2-2	-4	8	7	3	-3	-14	-17	-13
Tol. ±	2	2	2	2	2	2	2	2

Sound attenuation ΔL (dB), incl. end reflection

Table ΔL

Size	Mid-frequency (octave band) Hz							
	63	125	250	500	1000	2000	4000	8000
33-160-1-1	19	15	6	4	8	6	9	10
33-160-1-2	19	15	6	4	8	6	9	10
33-300-100-2-1	18	13	9	8	8	13	14	16
33-300-100-2-2	18	13	9	8	8	13	14	16
60-315-1-1	15	9	2	4	4	6	7	11
60-315-1-2	15	9	2	4	4	6	7	11
60-500-100-2-1	15	11	7	4	4	6	7	11
60-500-100-2-2	15	11	7	4	4	6	7	11
66-315-1-1	15	9	2	4	4	6	7	11
66-315-1-2	15	9	2	4	4	6	7	11
66-600-100-2-1	14	9	7	6	7	11	12	18
66-600-100-2-2	14	9	7	6	7	11	12	18
Tol. ±	2	2	2	2	2	2	2	2

Engineering graphs

Air velocity in occupied zone

- The graph shows the highest average velocity in the occupied zone at Δt 6°C.
- The measuring point is right underneath the diffuser.
- For CDH/CLH the air velocity must never exceed 0.2 m/s in the normal operating area.

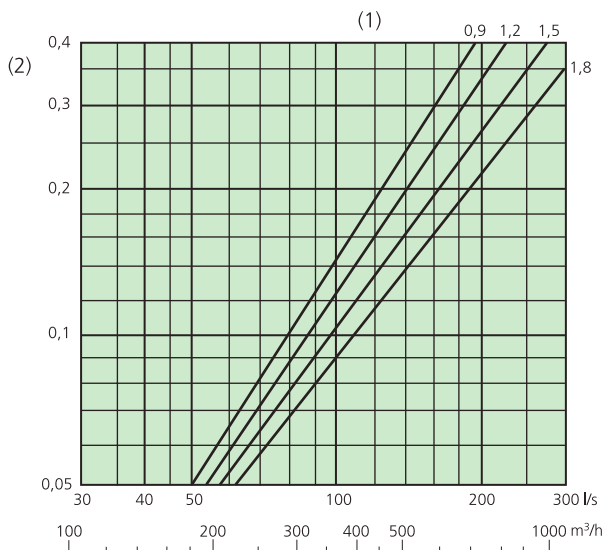

(1) Distance from the ceiling
 (2) Air velocity m/s

Supply air

Air flow – Pressure drop – Sound level – Throw

- The dB(A) value is for rooms with normal acoustic absorption (4 dB).
- Throw $l_{0,2}$ is measured under isothermal conditions.
- The graphs must not be used for commissioning.
- The dB(C) value is normally 6-9 dB higher than the dB(A) value.

- The light field shows the recommended working range to comply with H14 class.
- Extract air data, pressure drop and noise as for the supply air.

Circular connection

Size 33 - Perforated (390x390)

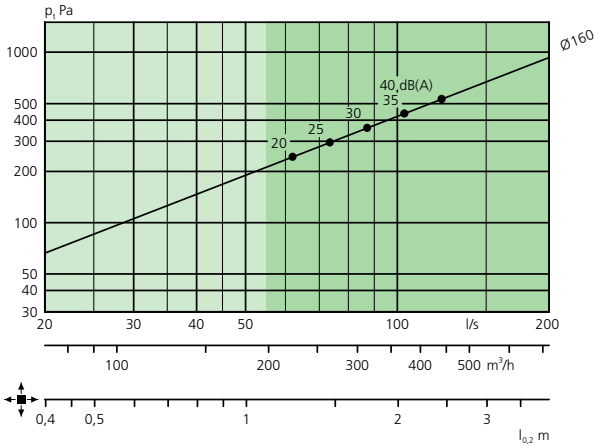

Rectangular connection

Size 33 - Perforated (390x390)

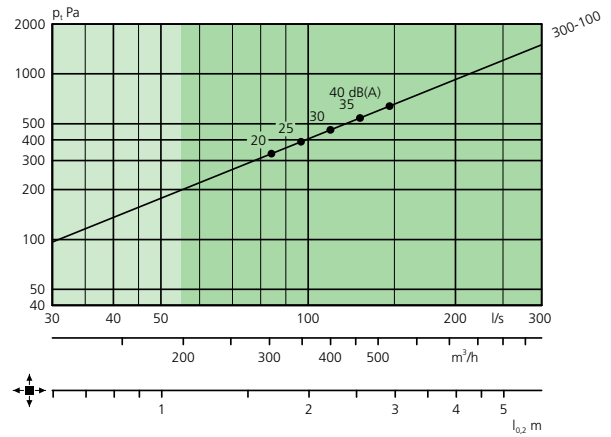

Size 60 - Perforated (595x595)

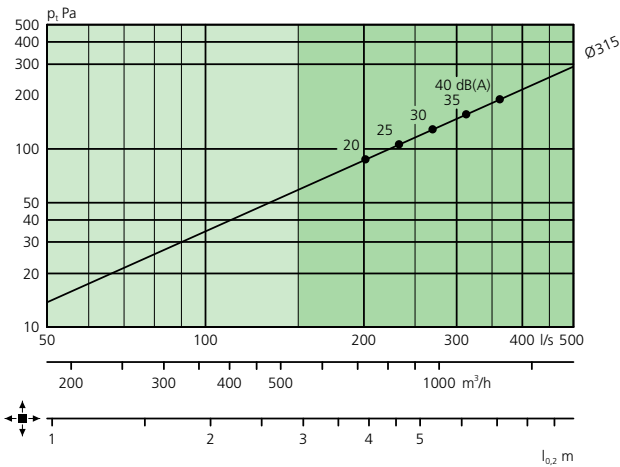

Size 60 - Perforated (595x595)

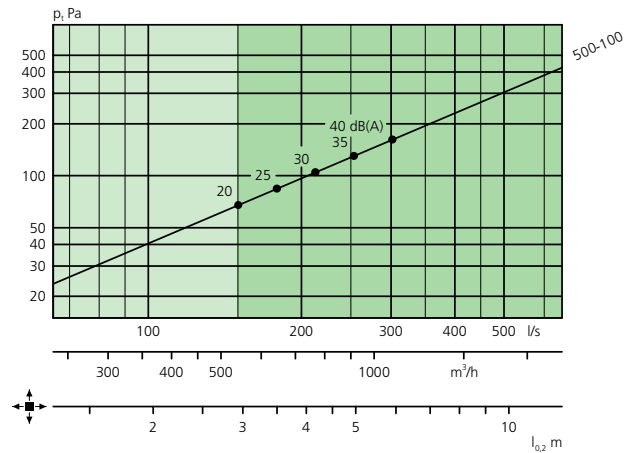

Size 66 - Perforated (693x693)

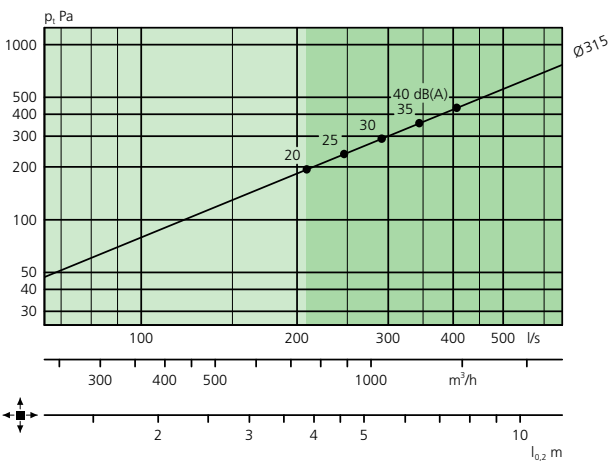

Size 66 - Perforated (693x693)

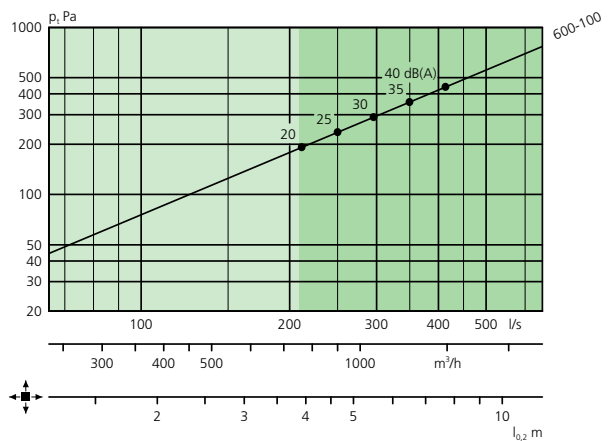

Circular connection

Rectangular connection

Size 33 - Nozzle diffuser (390x390)

Size 33 - Nozzle diffuser (390x390)

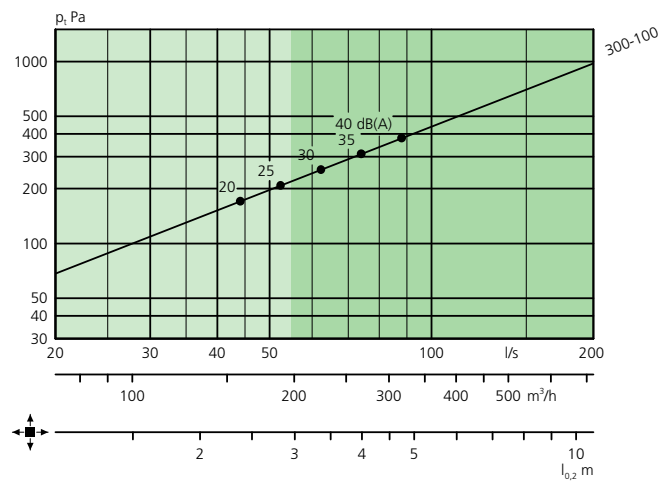
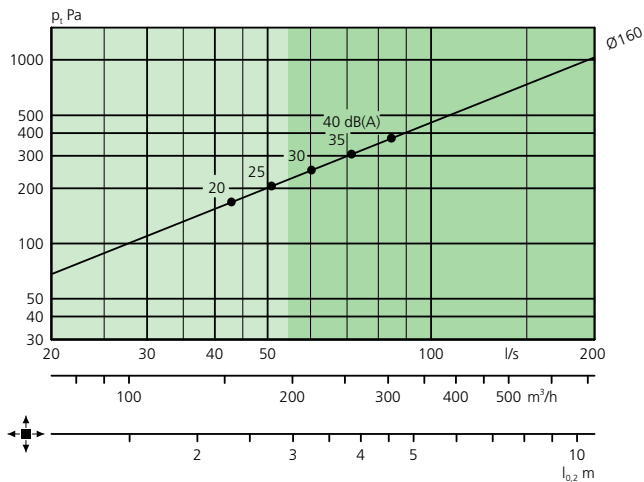

Size 60 - Nozzle diffuser (595x595)

Size 60 - Nozzle diffuser (595x595)

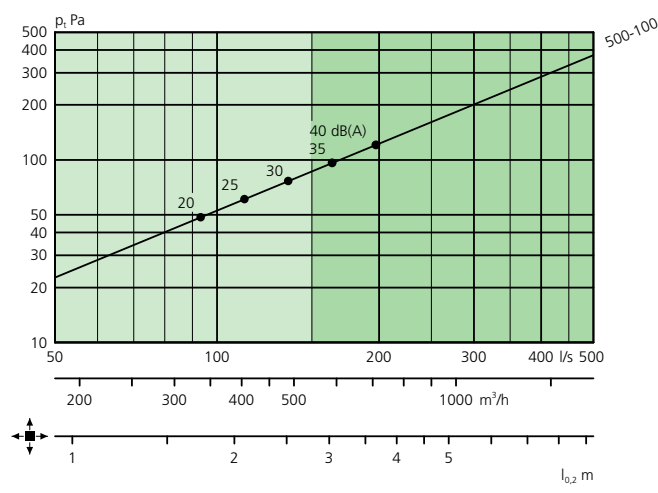
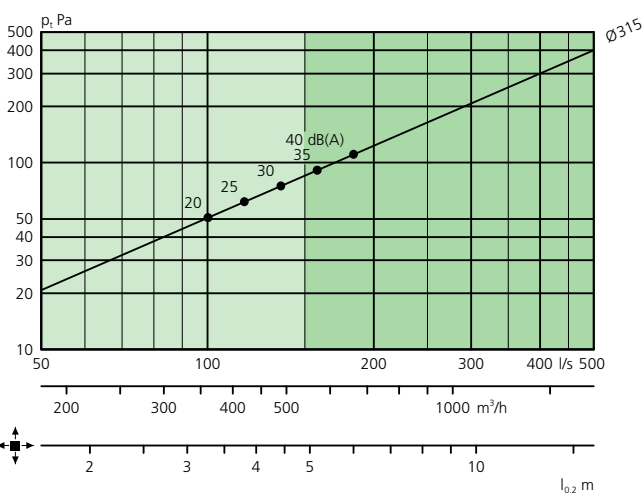

Size 66 - Nozzle diffuser (693x693)

Size 66 - Nozzle diffuser (693x693)

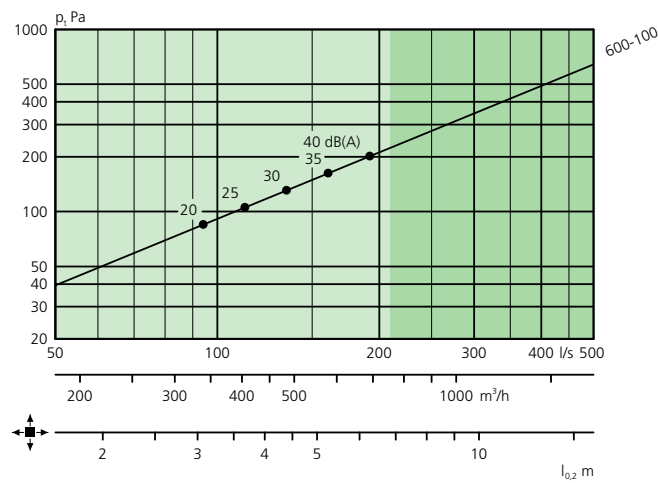
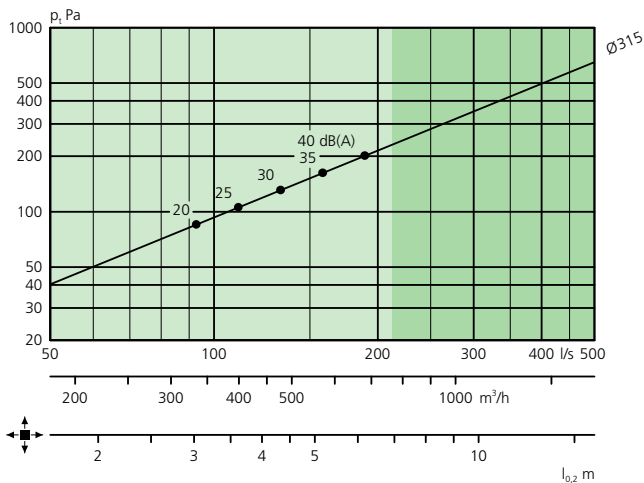

Dimensions and weights

Circular connection

Size	Dimensions (mm)					Weight ^{*)} (kg)
	A	B	ØD	L	N	
33-160	390	339	159	130	320	8,1
60-315	595	547	314	130	475	18,7
66-315	693	642	314	130	475	18

^{*)} Incl. filter

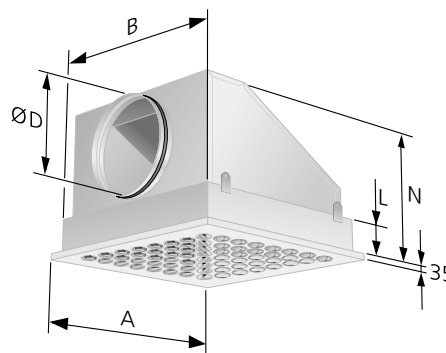

Figure 4. CDH/CLH, circular connection.

Rectangular connection

Size	Dimensions (mm)						Weight ^{*)} (kg)
	A	C x D	E x F	G	H	B1	
33-300x100	390	360x160	300x100	130	339	290	8,1
60-500x100	595	560x160	500x100	130	547	290	18,7
66-600x100	693	660x160	600x100	130	642	290	18

^{*)} Incl. filter

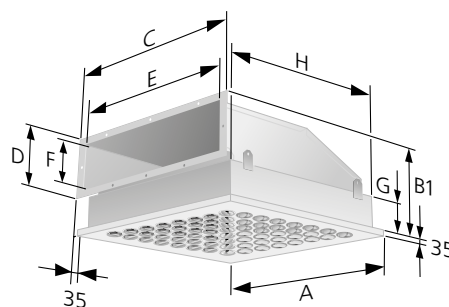

Figure 5. CDH/CLH, rectangular connection.

Number of nozzles for diffuser face with nozzles

Size		Number of nozzles
Circular	Rectangular	
33-160	33-300x100	25
60-315	60-500x100	64
66-315	66-600x100	64

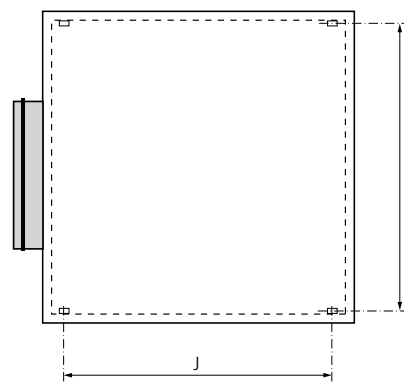

Figure 6. CDH/CLH, suspension (Measurements JxK in table Filter dimensions below).

Filter dimensions

Size		Length x Width x Height (mm)				Suspension measurements J x K (mm)
Circular	Rectangular	CDH-rubber seal	Weight (kg)	CLH-gel seal	Weight (kg)	
33-160	33-300x100	305 x 305 x 66	1,7	305 x 305 x 80	2,4	285x340
60-315	60-500x100	508 x 508 x 66	3,7	508 x 508 x 80	4,4	490x545
66-315	66-600x100	610 x 610 x 66	5,5	610 x 610 x 80	6,4	585x640

Nozzle settings

Standard nozzle setting is 4-way, throw length data according to the sizing diagram.

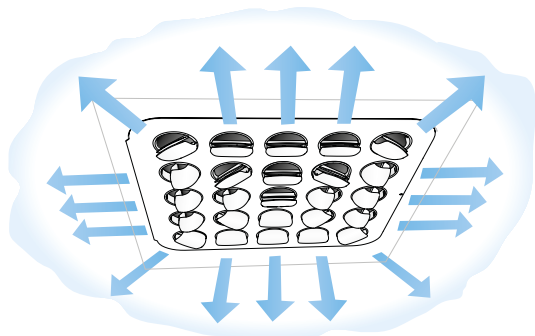
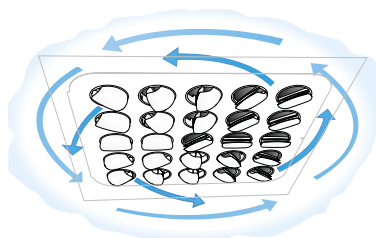

Figure 7. 4-way.

Alternative nozzle settings can be set according to the below. There is no throw length data for these.

Rotation



1-way

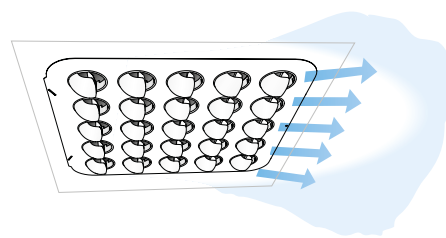

VK Vertical concentrated

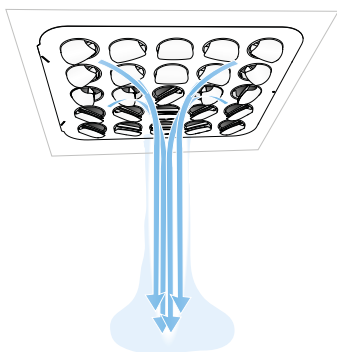

2C-way

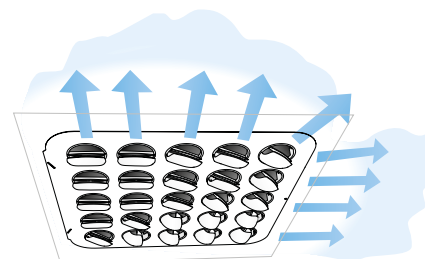

VD Vertical diffused

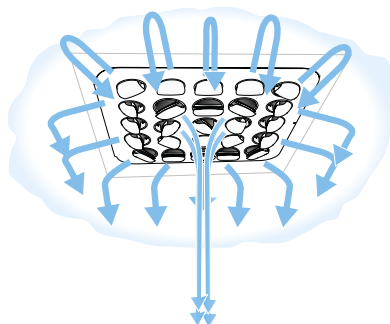

2M-way

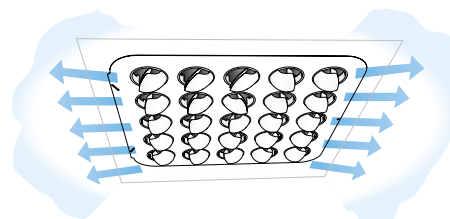

3-way

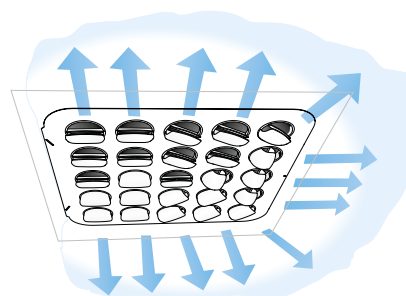

Order key

Product

Rubber-sealed Hepa-filter CDH b -aa -bbb(-ccc) -d -e
 Gel-sealed Hepa-filter CLH

Version:

Size: 33, 60, 66

Duct connection: See the table
 Standard range below

Connection type: See the table Standard range below
 Circular = 1
 Rectangular = 2

Type of diffuser face
 1 = Perforated
 2 = Nozzle diffuser

Specification example

Swegons ceiling module with Hepa-filter and nozzle or perforated diffuser face of type CDH/CLH, designed for use in clean rooms, having the following functions:

- Hepa-filter with gel seal or rubber gel
- Filtration efficiency 99.99% of particle size down to 0.3 µm
- Measurement point for vapour test and pressure measurement through filter
- Painted on exterior and interior
- Full disassembly possible for cleaning
- Powder coated in white, RAL 9003/NCS S 0500-N

Size	CLHb aa - bbb - ccc - d - 1	xx items
	CLHb aa - bbb - ccc - d - 2	xx items

Table,

Standard range	CDH/CLH
33-160-1-1	Perforated, circular connection
60-315-1-1	Perforated, circular connection
66-315-1-1	Perforated, circular connection
33-300-100-2-1	Perforated, rectangular connection
60-500-100-2-1	Perforated, rectangular connection
66-600-100-2-1	Perforated, rectangular connection
33-160-1-2	Nozzle diffuser, circular connection
60-315-1-2	Nozzle diffuser, circular connection
66-315-1-2	Nozzle diffuser, circular connection
33-300-100-2-2	Nozzle diffuser, rectangular connection
60-500-100-2-2	Nozzle diffuser, rectangular connection
66-600-100-2-2	Nozzle diffuser, rectangular connection