



CASA W3 Smart XS

A small giant among
ventilation units



Swegon CASA W3 Smart xs

W3 Smart xs is the lowest ventilation unit on the market and the quietest for its size. The unit with modular measurements (597 x 599 x 446 mm) is the answer for home less than 150 m² (80 l/s, 288 m³/h), and can be installed above a washing tower and leaves plenty of space for e.g. a folding rack. W3 Smart xs is a 740 W low energy model, whose low total output contributes to lower building costs. A preheater as standard and smart compensation functions ensure the ventilation works continuously and does not cause unnecessary negative pressure on cold winter days. It also features the market's smartest demand controlled humidity automation as standard.

Free energy with counterflow heat exchanger

The heat exchanger makes use of the energy in the indoor air in the winter to heat the incoming outdoor air and in the summer to reduce the supply air temperature. On a cold winter day the heat exchanger gives "free" heating energy up to 36°C by converting the -20° cold outdoor air to +16°C warm supply air. The heat exchanger is manufactured with aluminium fins and provides a high degree of efficiency. The supply air and extract air have completely separate air ducts so any possible odours in the extract air cannot be transferred to the supply air. The heat exchanger does not recover moisture to the supply air, which is advantageous in residences with a high moisture load (e.g. homes with a sauna).

Comfort or energy saving?

W3 Smart xs allows you to choose. The unit has two temperature settings that the user can choose: Eco and Comfort. In Eco mode the ventilation unit attempts to recover as much energy as possible in all situations. While in Comfort mode, the ventilation unit aims to keep the supply air temperature as even as possible.

Defrosting

The defrosting function guarantees continuous ventilation in the home even during cold conditions. With the help of the preheater (standard), you can maintain balanced ventilation and avoid negative pressure in the residence even under extreme conditions.

Preheater

With the help of the preheater (standard), you can maintain balanced ventilation and avoid negative pressure in the residence even under extreme conditions and enable balancing functions for fireplaces and cooker hoods. W3 Smart xs is a 740 W low energy model, whose low total output contributes, through smaller fuse sizes and the like, to lower building costs.

Reheater

Usually the recovered thermal energy from the extract air is sufficient to heat the supply air. In cold conditions, an electric reheater can be used to maintain a comfortable indoor climate. It can be placed internally in the air handling unit or externally in the duct (see technical data).

Automatic summer mode

Summer mode helps to maintain the home's indoor air comfort. The heat exchanger makes use of the cool indoor air during warm days and cools the incoming outdoor air. At night the home is cooled with fresh outdoor air. This is managed by an advanced automatic system that can be set according to the resident's requirements. Very economical comfort coolness can be produced intelligently almost free of charge.

Cooling

If there is access to cold water in the property (e.g. cooling pump), a cooling coil can be installed in the supply air/outdoor air duct to produce comfort cooling in the residence. The supply air temperature is controlled automatically from the ventilation unit's control system.

Separate connection for a cooker hood

The cooker hood can be connected via a separate duct to the unit. The cooker hood does not need a separate fan, duct, roof duct or roof hood. Permits balancing function for the cooker hood.

Installation

The unit can either be mounted on a wall or suspended from the ceiling using a separate ceiling mounting frame. As W3 is the market's lowest ventilation unit using counterflow technology and vertical air channels, it can also be easily mounted in confined areas, for example, above a washing machine with stacked clothes dryer.

- 1 Ecodesign energy class A*
- 2 Air flow range 36 - 288 m³/h
- 3 Temperature efficiency up to 82 % (EN 13141-7)
- 4 Demand-controlled humidity function as standard
- 5 Automatic summer function and passive cooling
- 6 Anti-frost protection ensures continuous ventilation
- 7 External coils for heating and cooling as an option
- 8 Can be connect to the automated building management system (I/O/Modbus)
- 9 Low installation height for installation above laundry columns

*Energy classification according to EcoDesign directive Lot 6. Energy class may vary depending on the selected accessories.



CASA Smart

CRIME
SCENE
HAND
WASH

WASH
HANDS
GENTLY

Washing Machine

10kg Capacity

Smart control technology

Controls (options)

CASA Smart ventilation units are equipped with the market's most versatile control options! Select the required control method or combine several!



Smart Access

Use your mobile device to control and monitor your indoor climate. Connect the Smart Access module to your ventilation unit and connect it to your home network.



Smart control panel

White wall mounted control panel with a colour display and touch buttons for both recessed and surface mounted installation.



Cooker hood

All Smart cooker hoods can be used to regulate the ventilation unit in three modes (home, away, boost). Automatically balances the ventilation when a cooker hood is used.



Building automation

Centralised monitoring and control with the help of Modbus connection modules or configurable I/O.

Basic functions

You can switch as required to an appropriate operating mode or let the pre-programmed weekly clock switch operating mode according to the diurnal rhythm you want.



Boosted air flow

A large air flow is used when the ventilation requirement increases, e.g. for cooking, taking a sauna, showering or drying laundry.



Home

Normal air flow. Guarantees that there is sufficient fresh indoor air in the home, and that the building construction is at its best.



Away

Low air flow. Reduces energy consumption when the ventilation requirement in the home is small.



Travelling

Very low air flow and lower supply air temperature. Used when no one is present in the home.

Compensation functions

Compensates ventilation flows in the home in order to facilitate for the inhabitants.



Fireplace function

An intelligent fireplace function that helps to produce the correct amount of replacement air, specifically for your fireplace. Facilitates lighting the fire and ensures clean combustion.



Cooker hood function

Balances the ventilation when a cooker hood is used. Helps to prevent excessive negative pressure and improves fume extraction capability of the cooker hood.



Central vacuum cleaner function

Balances the ventilation when a central vacuum cleaner is used. Helps to prevent excessive negative pressure and improves the cleaning result.

Automatic functions (options)

Intelligent ventilation is capable of identifying residents' needs. The Smart System measures the indoor air quality and knows exactly how much ventilation is required in different situations.



Intelligent humidity automation (RH) as standard

The market's most advanced moisture automation is now standard in all new Swegon CASA ventilation units. While traditional humidity sensors only switch the ventilation to boosted ventilation, the Smart Automation continuously analyses the indoor air and regulates the ventilation in accordance with the actual humidity variations.



Automatic Home/Away/Boost system (CO₂)

automatically lowers the ventilation to Away mode and saves energy when the home is empty. When the residents are at home, the ventilation is automatically increased to bring exactly the right amount of fresh air into the home.



Air Quality Automation (VOC)

increases the ventilation if too much pollution is detected in the indoor air, such as odours or vapours (evaporating organic compounds).

The Smart Control is easy to activate. The installation does not require cabling around the home, and can also be installed retrospectively in older Smart ventilation units.



Swegon



Ventilation

CO2

Humidity

41

44

22

Technical data

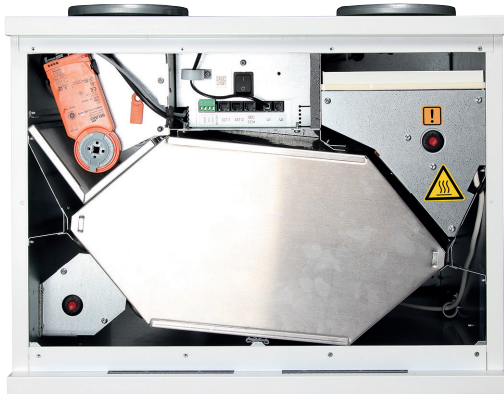

More information
in ProCASA

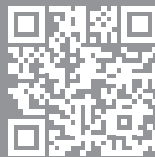

procasa.swegon.com

	W3 xs 740 W
Air flow range (according to Ecodesign)	36-288 m ³ /h
Rated voltage	230 V, 50 Hz, 10 A
Fans	230 W
Internal electric preheater	500 W
Internal electric reheater	500 W
External electric pre/reheater (Duct placement)	As an option
External water based heating coil/ cooling coil (Duct mounted)	As an option
Max. total output	740 W
Fuse protection	10 A
Weight	45 kg
Duct connections	Ø 125 mm
Outlet for condensate	3/8" male thread

Dimensions, w x l x h	597 x 599 x 446 mm
Heat exchangers	Counter-flow plate heat exchanger
Enclosure class	IP34
Control system	CASA Smart + automatic humidity function as standard
Control panel CASA Smart	Available as an option
Filters	Filter class ISO ePM1 50 % (F7) for supply air and ISO coarse (G3) for extract air
Colour, exterior	White, RAL 9016 (corresponds to NCS S1002-G50Y)

ENERG
енергия · ενεργεια

Y
IA
IE
IA

Swegon CASA W3SV*05*1*H* A
W3SV*05*L*H* A

39
dB

288 m³/h

ENERGIA · ЕНЕРГИЈА · ΕΝΕΡΓΕΙΑ · ENERGIJA · ENERGY · ENERGIE · ENERGI
2016 1254/2014

(SEC) in kWh

Cold climate	-78.0	A+
Mean climate	-40.3	A
Warm climate	-16.1	E

Energy class may vary depending on how the unit is equipped.



Dimensions

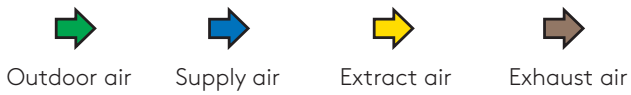

R-model from the front

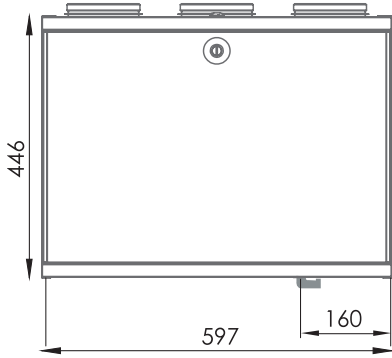

L-model from the front

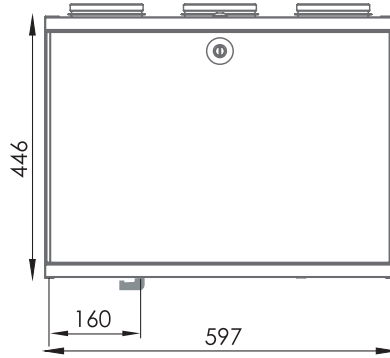

L / R model from the side

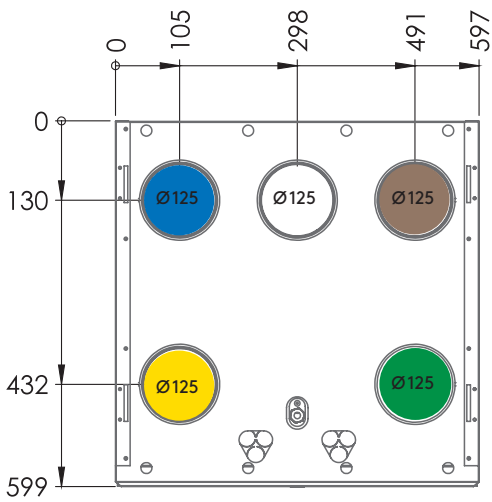
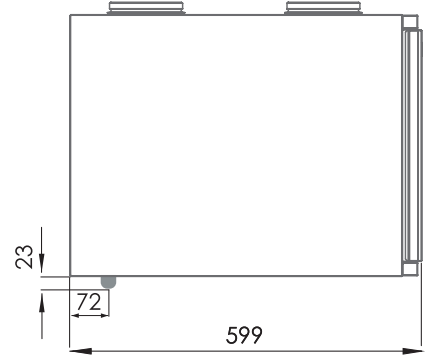

CASA W3 Smart XS R, right-hand version

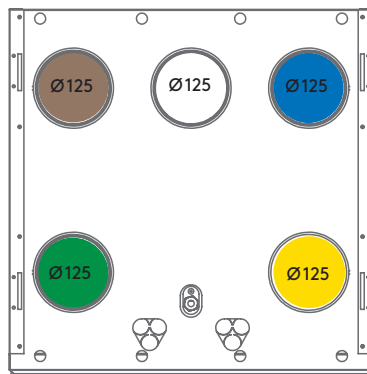

CASA W3 Smart XS L, left-hand version

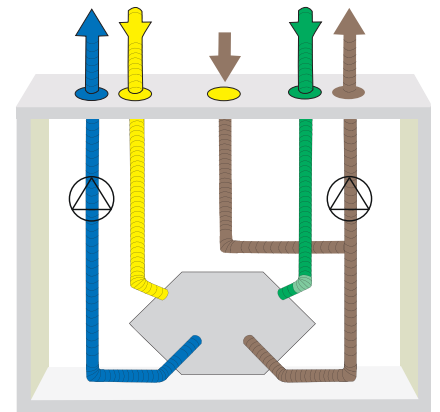

CASA W3 Smart XS R, right-hand version

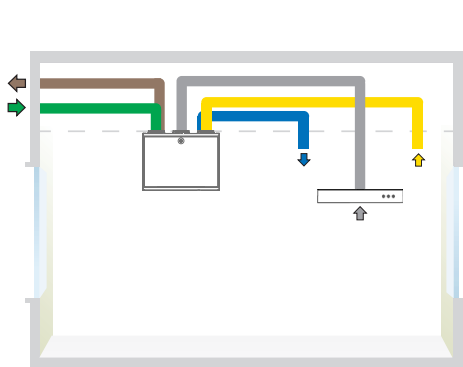

CASA W3 Smart XS L, duct connections and cooker hood connected to the ventilation unit's kitchen duct connection.

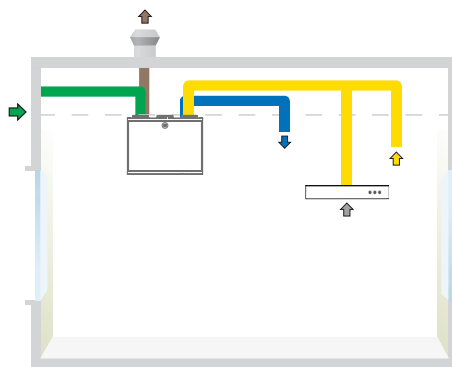

CASA W3 Smart XS L, duct connections and cooker hood connected to the extract air duct.

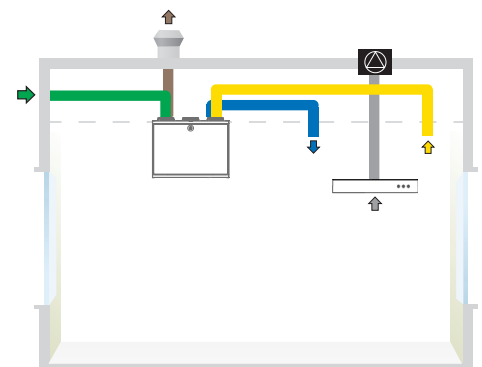

CASA W3 Smart XS L, duct connections and cooker hood connected to the external ceiling fan.

Note! Always check the unit design (L/R) and correct duct sequence in the installation instructions.

Fan curves

More detailed data for sound to the surroundings and duct connections are available via procasa.swegon.com.

Airflow

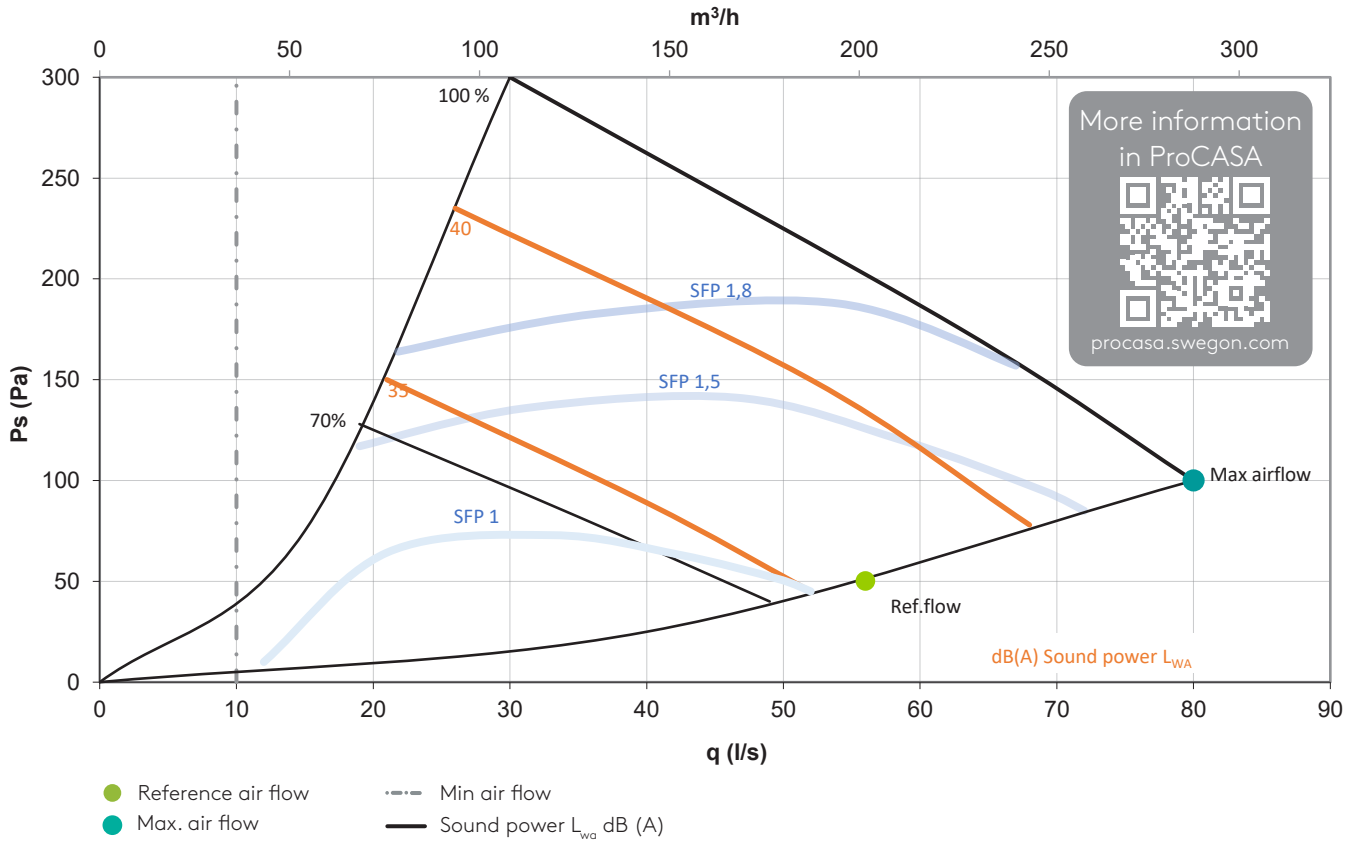

	Sound power level L_w (dB), table K_{OK}							
	63 Hz	125 Hz	250 Hz	500 Hz	1000 Hz	2000 Hz	4000 Hz	8000 Hz
Sound emitted to the surroundings	14	11	5	-7	-18	-27	-28	-33

For more detailed sound data refer to the calculation software Procasa



- 1 Smart ventilation takes care of the indoor air quality automatically
- 2 It knows when you leave home and when you come back
- 3 It knows when you do laundry, shower or cook food
- 4 It adjusts ventilation accordingly based on your current need
- 5 It guarantees fresh and healthy indoor climate

Air handling unit and accessories

CASA W3 Smart xs



- 36-288 m³/h, 4 x Ø125 mm + Ø125 mm
- Supplied with approx. 1.5 m controlled cable. Order control panel and 10 m/20 m extension cable separately.
- Humidity automation as standard (RH)
- Please order also wall mounting bracket (WRWMB) or ceiling mounting frame (W03CMB) together with AHU

Part no.	Energy class*	Description
W3SVR05SL0HA	A+ / A / E	CASA W3 Smart xs R 740W Abp RH
W3SVL05SL0HA	A+ / A / E	CASA W3 Smart xs L 740W Abp RH

L = exhaust air left. *Energy classification according to EcoDesign directive Lot 6 (Cold/**Medium**/Warm).

Filter



W304F	Spare filter ISO ePM1 50% (F7) for supply air and ISO coarse (G3) for extract air
W304FSF8	Allergy filters for W3 and W4 units when cleaner supply air is required. Filter class ISO ePM1 70 % (F8) for supply air and ISO coarse (G3) for extract air. It should be noted that a separate setting of the unit is necessary and that filters must be replaced more often than standard filters.

Control accessories

White wall mounted control panel with a colour display and touch buttons for both recessed and surface mounted installation.



SC10	Control panel (1-2 per unit)
SC14	SC10 + modular cable 10 m
SC15	SC10 + modular cable 10 m + mounting frame
SC16	SC10 + mounting frame
102SAK	Mounting frame, for surface mounting of the control panel
PMK20	Modular cable, 20 m and RJ9 adapter for units
604010	Modular cable 10m



Use your mobile device to control and monitor your indoor climate. Connect the Smart Access module to your ventilation unit and connect it to your home network.



SMA	Smart Access module for connection to the internet
SMAW	Smart Access module + WLAN router
SMAG	Smart Access module + 3G/4G mobile router (not SIM)

Building automation

As standard the ventilation unit has two configurable I/O channels. If there is a need of additional connection points, the ventilation unit has space for a separate connection cable (SEC). Modbus connection module (SEM) gives you advanced connection options to a master system.



SEM	Modbus connection module
SEC	Connection cable (configurable I/O) for Smart ventilation units
WSTC	Room temperature sensor, total package with connection unit for ventilation units. The sensor is installed on the wall or in a recessed junction box (60 mm between holes).

Automatic functions

With the help of an internally mounted sensor, it is easy to fully automate your apartment's ventilation system. Can easily be retro-fitted by replacing the existing internal RH-sensor.



SRHCO2	Automatic Home/Away/Boost system + humidity automation (RH + CO ₂)
SRHVOC	Automatic air quality system + humidity automation (RH+VOC)

Waterborne air coolers



With an air cooler mounted in the supply air duct, comfort cooling is created in the residence by connecting a cooling medium circuit or a cooling water circuit to the cooler. The air cooler is controlled automatically from the ventilation unit's Smart control system and settings can be changed using a CASA Smart control panel. The delivery includes: Air cooler, SET connection module, actuator and 3-way valve, 24 V transformer, requisite sensors and instructions.

SDCW160	Cooling coil pack Ø160
---------	------------------------

Waterborne air heaters

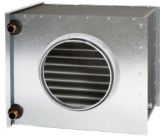

In buildings equipped with a waterborne heating system, the supply air can be heated with a duct mounted waterborne air heater. The air heater is controlled automatically from the ventilation unit's Smart control system and settings can be changed using a CASA Smart control panel. The delivery includes: Air heater, SET connection module, actuator and 3-way valve, 24 V transformer, requisite sensors and instructions.

SDHW125	Heating coil package Ø125
SDHW160	Heating coil package Ø160

Brine air heater/cooler for ground source heat pump



In a property equipped with a ground source heat pump, a brine air heater/cooler for the heat pump can be installed in the outdoor air duct. In the winter it heats the air taken in and ensures that the ventilation unit operates with the greatest efficiency even in extreme cold. In the summer, the medium in the ground circuit is used to cool the building. The control technology in CASA Smart automatically ensures that the air heater/cooler is utilised optimally all year round. The delivery includes: heating/cooling coil, wall mounting bracket/ceiling mounting frame, an effective 4-row air cooler for cooling medium, SET connection module, coarse filter, requisite sensors and instructions and drip tray for condensate water: condensation water outlet with 3/8" male thread.

SDHW250F	Heating/cooling coil Ø250, G4
----------	-------------------------------

Electric air heater



Can be used for preheating and is placed in the outdoor air duct to guarantee continuous ventilation under very cold conditions and permit balancing functions (fireplace function/function for a cooker hood) in the air handling unit without an integrated air heater for preheating. With W-series that have integrated heaters, this accessory is typically used for air heated apartments. If the air heater is to be installed as a preheater, a FLK-filter needs to be installed in the duct in front of the preheater. The electric duct heater has built-in regulation and is controlled directly from a ventilation unit. The heater is connected using a separate power supply 230 V. The delivery includes: air heater, SET connection module, requisite sensors and instructions.

SDHE125-1T	Electric heater Ø125
SDHE160-1T	Electric heater Ø160
FLK12	Prefilter box Ø125 mm, G4
FLK16	Prefilter box Ø160 mm, G4

Other accessories

Used for connection of external accessories, for example, damper, duct coils, etc.



SET	Connection module for control of the duct mounted air heater/cooler / control of shut-off dampers
POWER24V20W	SET / power source for actuators



UVLL	Very low water trap that is easy to clean
------	---



The constant duct pressure function on the Smart ventilation unit attempts to regulate the fan speeds to maintain the duct pressure at the set value. Individual setting values for the duct pressure should be determined for each operating mode (away, home, boost). The operating mode can be switched as normal when the constant duct pressure function is used.

PTH	PTH Regulation for constant duct pressure
-----	---

Mounting frame with quick-fit connectors for ceiling mounting the ventilation unit. Simplifies connection as the duct system can be fully installed prior to the installation of the ventilation unit.



W03CMB	Ceiling mounting frame
W034CMP	Cover plate for ceiling mounting frame, for flush mounting
W034CNR	W3 and W4, frame with sound trap. Even lower sound level to the surroundings and gives the final touch to the installation. Any mouldings and the like are not necessarily needed.
WRWMB	Wall mounting bracket

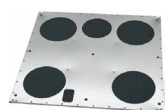

Vapour barrier which prevents moisture from entering the insulation in the attic joist floor and stops the air from the loft from coming down into the rooms.

PW080YP	Vapour barrier for mounting frame
W05FMB	Floor base for W5, W4, W3 and R5. Please notice the depth of the base is 620 mm.



Duct mounted shut-off dampers type 4 and damper actuator 24 V with spring return. The damper closes in the event of a power failure or alarm when a risk of freezing exists. The damper actuator is electrically connected to a CASA SET-module. SET module and 24 V adapter is ordered separately as required.

SDD125	CASA Damper Ø125 24V
SDD160	CASA Damper Ø160 24V

Feel good **inside**



Swegon 